

UNIFIED FACILITIES CRITERIA (UFC)

FIRE PROTECTION ENGINEERING FOR FACILITIES



APPROVED FOR PUBLIC RELEASE; DISTRIBUTION UNLIMITED

UNIFIED FACILITIES CRITERIA (UFC)
FIRE PROTECTION ENGINEERING FOR FACILITIES

Any copyrighted material included in this UFC is identified at its point of use. Use of the copyrighted material apart from this UFC must have the permission of the copyright holder.

U.S. ARMY CORPS OF ENGINEERS

NAVAL FACILITIES ENGINEERING COMMAND (Preparing Activity)

AIR FORCE CIVIL ENGINEER CENTER

Record of Changes (changes are indicated by \1\ ... /1/)

Change No.	Date	Location
1	28 Nov 2016	<u>Change to definition of 'AHJ' (paragraph 2-1.3) required modifications to paragraphs 1-7.2.2, 1-9, 9-16.1, and 9-18.5.1. Change to paragraph 9-13.1.3 was a technical change.</u>
2	25 Mar 2018	<u>Clarification to definitions <i>Fire Water Demand</i> (2-1.11) and <i>Multi-Family Housing</i> (2-1.26), in addition to many clarifications of requirements. Paragraphs added for <i>Hydroelectric Generating Plants</i>(4-20) and <i>Navigation Locks</i>" (4-31). Change in requirements for <i>Liquid Oxygen</i> (4.3-33). Army eliminated the requirement for two water storage tanks. DLA requires redundant fire pump for large risk facilities. Dry pipe systems require nitrogen.</u>
3	10 May 2019	Added Paragraph 1-2.1.3.1 referring to new Appendix G Change Paragraph 4-14.1 to apply to all family housing. Added Paragraph 4-46 for wildland-urban interface. Moved Paragraph 9-2.2.2 to where it should have been located.

UFC 3-600-01
8 August 2016
Change 5, 24 September 2020

		<p>Clarified Paragraph 9-5.3.2 to follow NFPA 20 for run time.</p> <p>Changed Paragraph 9-6.3.5 friction loss requirements.</p> <p>Added Paragraph 9-19.2.3, CO detection for large spaces.</p> <p><u>Added Appendix G, requirements for Host Nation projects in Japan.</u></p> <p><u>Some changes made to clarify requirements.</u></p>
4	3 Feb 2020	<p>Added/changed requirements (9-9.3 and 9-17) to comply with 2020 NDAA.</p> <p>Added 4-38.2 to allow FEMA approved Tank and Pump Systems.</p> <p>Other changes added clarity.</p>
5	24 Sep 2020	<p>Added section 4-2, Additive Manufacturing to address 3-D printing.</p> <p>Added section 4-39, Privacy Pods or Privacy Enclosures Included Lake Projects to section 4-32, Navigation Locks.</p> <p>Added a requirement in section 4-32 to protect hydraulic reservoir and pumping equipment.</p> <p>Added section 10-5, Communicating Space to provide clarity to the code allowances.</p> <p>Made changes to Chapter 34 to simplify requirements.</p> <p>Other changes were made to provide coordination, clarification, or correct formatting.</p>

This UFC supersedes UFC 3-600-01, dated 26 September 2006, Change 3 and all preceding changes.

FOREWORD

The Unified Facilities Criteria (UFC) system is prescribed by MIL-STD 3007 and provides planning, design, construction, sustainment, restoration, and modernization criteria, and applies to the Military Departments, the Defense Agencies, and the DoD Field Activities in accordance with [USD \(AT&L\) Memorandum](#) dated 29 May 2002. UFC will be used for all DoD projects and work for other customers where appropriate. All construction outside of the United States is also governed by Status of Forces Agreements (SOFA), Host Nation Funded Construction Agreements (HNFA), and in some instances, Bilateral Infrastructure Agreements (BIA.) Therefore, the acquisition team must ensure compliance with the most stringent of the UFC, the SOFA, the HNFA, and the BIA, as applicable.

UFC are living documents and will be periodically reviewed, updated, and made available to users as part of the Services' responsibility for providing technical criteria for military construction. Headquarters, U.S. Army Corps of Engineers (HQUSACE), Naval Facilities Engineering Command (NAVFAC), and Air Force \2\ Civil Engineer Center (AFCEC) /2/ are responsible for administration of the UFC system. Defense agencies should contact the preparing service for document interpretation and improvements. Technical content of UFC is the responsibility of the cognizant DoD working group. Recommended changes with supporting rationale should be sent to the respective service proponent office by the following electronic form: [Criteria Change Request](#). The form is also accessible from the Internet sites listed below.

UFC are effective upon issuance and are distributed only in electronic media from the following source:

- Whole Building Design Guide web site <http://dod.wbdg.org/>.

Hard copies of UFC printed from electronic media should be checked against the current electronic version prior to use to ensure that they are current.

AUTHORIZED BY:



JAMES C. DALTON, P.E.
Chief, Engineering and Construction
U.S. Army Corps of Engineers



JOSEPH E. GOTT, P.E.
Chief Engineer
Naval Facilities Engineering Command



EDWIN H. OSHIBA, SES, DAF
Deputy Director of Civil Engineers
DCS/Logistics, Engineering &
Force Protection



MICHAEL McANDREW
DASD (Facilities Investment and Management)
Office of the Assistant Secretary of Defense
(Energy, Installations, and Environment)

UNIFIED FACILITIES CRITERIA (UFC)

REVISION SUMMARY SHEET

Document: UFC 3-600-01, *Fire Protection Engineering for Facilities*

Superseding: This UFC supersedes UFC 3-600-01, dated 26 September 2006, Change 3 and all preceding changes.

Description of Changes: This update to UFC 3-600-01 clarifies many of the requirements in the 26 September 2006, Change 3, 1 March 2013 version, as well as updates references, and further coordinates the Services' requirements. This update also coordinated requirements with consensus standards and reorganized the document to match the organization of the IBC to make it easier to use for the Architectural-Engineering Firms. New criteria for the following were added:

- Planning Section
- Definitions
- Facilities Housing Unmanned Aerial Vehicles (UAV) or Remotely Piloted Aircraft (RPA)
- Military Operations on Urban Terrain (MOUT) Trainers
- Sensitive Compartmented Information Facility (SCIF)

Reasons for Changes:

- Planning Section is to help scope projects properly and assist in ensuring the proper funding is requested
- Definitions are to help clarify requirements
- Requirements were added for UAVs to ensure the UAVs and the facility are properly protected
- Information was added for MOUTs to ensure they have the proper protection and are not provided with unnecessary requirements.
- Requirements were added for SCIFs to ensure coordination with the security requirements.

Unification Issues:

Some criteria are Service specific as it will reference a Service UFC, FC, Instruction, or Manual.

Navy Unification Issues:

- Paragraph 7-2 – The spacing allowed by the IBC for the identification of the rated wall is too large and will not be easily seen by trade personnel performing work.

Air Force Unification Issues:

- Paragraph 9-5.4.3 – This paragraph is an option allowed by code. This choice only adds a single engine driven generator and associated maintenance burden, rather than add multiple engine driven drivers and the associated maintenance burden.
- Paragraph 34-10.1.1 – There are many existing Air Force Lodging and Billeting Facilities without sprinkler protection. Requirements are different and exceed those found in minimum criteria, including NFPA 101. The requirements are unique to the Air Force and this section is needed to prevent change to Air Force facilities simply because it is different.

Army Unification Issues:

- Paragraph 4-3.4.8 – Provides additional requirements for facilities that support UAV or UAS.\4\
- /4/Paragraphs 9-6.3.2 and 9-18.2 – Requires fire protection shop drawings prepared under the immediate supervision of and sealed by a professional engineer, who must certify in writing that the system was installed as designed.

This Page Intentionally Left Blank

TABLE OF CONTENTS

CHAPTER 1 INTRODUCTION	1
1-1 SCOPE AND ADMINISTRATION.	1
1-2 APPLICABILITY.....	1
1-2.1 General.....	1
1-2.2 Acronyms, Abbreviations, Defined Terms, and Referenced Criteria.....	1
1-2.3 Fire Department Operations.	1
1-3 PURPOSE.	2
1-4 CRITERIA.....	2
1-4.1 Federal Laws.	2
1-4.2 DoD Criteria.....	2
1-4.3 Standards, Codes and Guides.....	3
1-4.4 Antiterrorism and Security Standards.	3
1-5 GENERAL BUILDING REQUIREMENTS.	3
1-6 REFERENCES AND DATES OF PUBLICATION.....	4
1-6.1 General.....	4
1-6.2 Project Delays.....	4
1-7 FIRE PROTECTION ENGINEERING SERVICES.....	4
1-7.1 General.....	4
1-7.2 Fire Protection Design Analysis and Life Safety Plans.	4
1-7.3 Final Design Submission.	8
1-7.4 Host Nation.....	8
1-8 EQUIVALENCIES.	8
1-9 EXEMPTIONS.....	9
1-10 PERFORMANCE-BASED FIRE SAFETY DESIGN.....	9
1-10.1 General.....	9
1-10.2 Application.	9
1-11 FIRE PROTECTION DURING CONSTRUCTION.	10
1-12 PLANNING\2\ (CONTRACT DOCUMENT DEVELOPMENT)/2/.....	10
1-12.1 General.....	10
1-12.2 <i>Installation</i> Water Supply.	10
1-12.3 <i>Installation</i> Water Distribution.	10

1-12.4	<i>Installation On-Site \2\Water/2/ Storage.</i>	11
1-12.5	Waterflow Testing.	11
1-12.6	<i>Fire Flow.</i>	12
1-12.7	Fire Pumps.	12
1-12.8	Automatic Sprinkler Systems.	12
1-12.9	Clean Agent Fire Extinguishing Systems.	12
1-12.10	Rural, Remote, \3\and Range/3/ Locations.	13
1-12.11	Military Operations on Urban Terrain (MOUT) Trainers.	13
1-12.12	Warehouses and Storage <i>Facilities.</i>	13
1-12.13	Existing <i>Facilities.</i>	13
1-13	CYBERSECURITY	13
CHAPTER 2 DEFINITIONS		15
2-1	GENERAL	15
2-1.1	Addition.....	15
2-1.2	\5\5/Authority Having Jurisdiction (AHJ).....	15
2-1.3	/1/Bin Storage.....	16
2-1.4	Distribution Main.	16
2-1.5	DoD Component.	16
2-1.6	Dwelling Unit.....	16
2-1.7	Electronic Equipment Area.	16
2-1.8	Exemption.....	16
2-1.9	Facility.....	16
2-1.10	Fire Alarm Reporting System.....	17
2-1.11	Fire Area.....	17
2-1.12	Fire Flow.	17
2-1.13	Fire Water Demand.	17
2-1.14	Fire Protection Engineer.	17
2-1.15	Incidental Electronic Equipment.....	17
2-1.16	\5\5/Installation.....	18
2-1.17	Life Safety System.....	18
2-1.18	Major Project.....	18
2-1.19	Mass Notification System.....	18

2-1.20	\2\2/Medical Facilities.	19
2-1.21	Missile Alert Facilities (MAF).....	19
2-1.22	Missile Assemblies.	19
2-1.23	\5\5/Multi-Family Housing.	19
2-1.24	Noncombustible Material.	19
2-1.25	Ordnance Facility.....	19
2-1.26	\5\5/Reliable Power Source.	19
2-1.27	\5\ /5/Review Stamp.....	20
2-1.28	Sensitive Compartmented Information Facility (SCIF).	20
2-1.29	Service Lateral.....	20
2-1.30	Service Main.....	20
2-1.31	Stakeholders.....	20
2-1.32	Telecommunications Equipment Areas.	20
2-1.33	Tension Membrane Structure.	20
2-1.34	Very Early Warning Smoke Detection.....	21
CHAPTER 3 USE AND OCCUPANCY CLASSIFICATION		23
3-1	GENERAL	23
3-2	INTERNATIONAL BUILDING CODE (IBC).	23
3-2.1	General.....	23
3-3	NFPA 101.....	23
3-3.1	General.....	23
3-4	HAZARDOUS MATERIALS.	23
CHAPTER 4 SPECIAL DETAILED REQUIREMENTS BASED ON USE.....		25
4-1	GENERAL.	25
4-2	\5\ADDITIVE MANUFACTURING (3D PRINTING TECHNOLOGY AND COLD SPRAY MATERIAL-DEPOSITION PROCESS TECHNOLOGY).	25
4-2.1	General.....	25
4-2.2	Additive manufacturing processing equipment.	25
4-3	AIRCRAFT ACOUSTICAL ENCLOSURES.	25
4-3.1	Complete Enclosures (Hush House).....	25
4-3.2	Out of Airframe Acoustical Enclosures (Test Cells).	26
4-4	AIRCRAFT FACILITIES.	26

4-4.1	Aircraft Hangars.....	26
4-4.2	Tensioned-Membrane Hangars.....	26
4-4.3	Aircraft Weather Covering.....	26
4-4.4	<i>Facilities</i> Housing Unmanned Aerial Vehicles (UAV) or Remotely Piloted Aircraft (RPA).....	27
4-5	ANECHOIC CHAMBERS.....	29
4-6	CHILD DEVELOPMENT PROGRAMS.....	29
4-6.1	Child Development Centers (CDC).....	29
4-6.2	Continuous Child Care Facilities (24/7).	29
4-6.3	Other Child Development Programs.....	29
4-6.4	Youth Centers.....	29
4-7	COAL.....	30
4-7.1	General.....	30
4-7.2	Pulverizing Equipment.....	30
4-8	COMMISSARIES AND EXCHANGES.....	30
4-8.1	Mixed Occupancy.....	30
4-8.2	Standalone.....	30
4-9	COMPACT MOBILE SHELVING.....	30
4-9.1	Reserved.....	30
4-10	DEPARTMENT OF DEFENSE EDUCATION ACTIVITY (DODEA).....	30
4-11	DETENTION AND CORRECTIONAL FACILITIES.....	30
4-11.1	Requirements.....	30
4-12	ELECTRONIC EQUIPMENT AREAS.....	31
4-12.1	General.....	31
4-12.2	Telecommunication Equipment Areas.....	32
4-12.3	Smoke Detection.....	32
4-12.4	Sprinkler Systems.....	32
4-12.5	Clean Agent Fire Extinguishing System.....	33
4-12.6	Electronic Equipment Power Disconnect.....	33
4-12.7	Power and Communication Cabling.....	34
4-13	ELEVATORS.....	34
4-13.1	General.....	34

4-13.2	\2\2/Fire-Resistant Construction.	34
4-13.3	Detection.....	34
4-13.4	Sprinkler Protection.	35
4-13.5	Host Nation.	36
4-14	EMERGENCY SERVICES COMMUNICATIONS CENTERS.....	40
4-15	FAMILY HOUSING.....	40
4-15.1	General.....	40
4-15.2	<i>Off-Installation</i> Family Housing within the United States and its Territories.....	40
4-15.3	Family Housing Outside the United States and its Territories and Possessions.....	40
4-15.4	DoD-Leased Family Housing.	41
4-15.5	<i>Multi-Family Housing</i>	41
4-15.6	One- and Two-Family Housing.	41
4-15.7	<i>1/2</i> /Cooking Areas.	41
4-16	FOOD PREPARATION IN FACILITIES.	41
4-16.1	Commercial Cooking Equipment.	41
4-16.2	Residential Cooking Equipment.....	41
4-17	HAZARDOUS MATERIALS AND HAZARDOUS WASTE.....	42
4-17.1	General.....	42
4-17.2	Hazardous Materials Storage Areas.	43
4-17.3	Hazardous Waste Storage <i>Facilities</i>	43
4-17.4	Spill Control and Containment.	44
4-17.5	Electric Wiring and Equipment.....	44
4-17.6	Ventilation.....	44
4-17.7	Prefabricated Structures.	44
4-17.8	Outdoor Storage Limitations and Separation.....	44
4-18	HIGH-RISE BUILDINGS.....	45
4-18.1	General.....	45
4-18.2	Emergency Command Center.	45
4-18.3	Fire Service Access Elevators.	45
4-18.4	Buildings Greater than 420 feet (128 m).....	46
4-19	HISTORIC FACILITIES.	46

4-19.1	General.....	46
4-20	HYDRAULIC SYSTEMS.....	46
4-20.1	General.....	46
4-20.2	Petroleum-Based Hydraulic Fluids.....	46
4-20.3	Hydraulic Test Systems.....	46
4-21	\2HYDROELECTRIC GENERATING PLANTS.....	47
4-21.1	Hydroelectric Generating Plants.....	47
4-21.2	Indoor Transformers.....	47
4-21.3	Outdoor Transformers.....	48
4-21.4	Hydroelectric Generators.....	48
4-21.5	Oil Storage and Oil Purification Rooms.....	49
4-21.6	Paint and Flammable Liquid Storage Rooms.....	49
4-21.7	\5\ Fire Alarm.....	49
4-22	HYDROGEN FACILITIES.....	49
4-22.1	Liquid Hydrogen (LH ₂).....	49
4-22.2	Gaseous Hydrogen (GH ₂).....	49
4-22.3	Indoor Fueling or Dispensing.....	49
4-23	HYPERBARIC AND HYPOBARIC CHAMBERS.....	49
4-23.1	Hyperbaric Chambers.....	49
4-23.2	Hypobaric Chambers.....	50
4-24	LABORATORIES.....	50
4-24.1	General.....	50
4-25	HISTORIC RESOURCE LIBRARIES, ARCHIVES, AND FACILITIES....	50
4-25.1	General.....	50
4-26	LIMITED ACCESS AND UNDERGROUND STRUCTURES.....	50
4-26.1	General.....	50
4-26.2	Limited Access Structures.....	50
4-26.3	Underground Structures.....	51
4-27	MEDICAL FACILITIES.....	51
4-28	MILITARY OPERATIONS ON URBAN TERRAIN (MOUT) TRAINERS.	51
4-29	MISSILE ALERT FACILITIES (MAF).....	51
4-29.1	Sprinkler Protection.....	51

4-29.2	Heat Detectors.....	51
4-29.3	Fire Hydrants.	51
4-30	MORALE WELFARE AND RECREATION FACILITIES (MWR).	52
4-31	NATURAL GAS SERVICE.....	52
4-31.1	General.....	52
4-32	\2\NAVIGATION LOCKS \5\AND LAKE PROJECTS\5/.	52
4-32.1	General.....	52
4-32.2	Navigation Locks./5/	52
4-33	ORDNANCE.	53
4-33.1	<i>Installation Ordnance Facilities.</i>	54
4-33.2	Ammunition/Explosives (A/E) Storage Facilities.	54
4-33.3	Stored Missile Assemblies.	54
4-33.4	<i>Other Ordnance Facilities.</i>	55
4-33.5	<i>Ordnance Production Facilities.</i>	55
4-34	OXYGEN.	59
4-34.1	General.....	59
4-34.2	Gaseous oxygen (GOX).....	59
4-34.3	Liquid Oxygen (LOX).	59
4-34.4	Combined LOX and GOX <i>Facilities.</i>	61
4-35	PERSONNEL HOUSING AND SIMILAR LODGING FACILITIES.	61
4-35.1	General.....	61
4-35.2	Automatic Sprinkler Protection.....	62
4-35.3	Smoke Detection.	62
4-35.4	Cooking Areas.	62
4-36	PESTICIDE STORAGE AND HANDLING FACILITIES.	62
4-36.1	General.....	62
4-37	PETROLEUM, OILS & LUBRICANTS (POL) FACILITIES.....	63
4-37.1	General.....	63
4-37.2	Fuel Testing Laboratories.	63
4-37.3	Fuel Piers.....	63
4-38	POWER GENERATING AND UTILIZATION EQUIPMENT.	64
4-38.1	Power Generating Plants.	64

4-38.2	Substations.....	64
4-38.3	Stationary Combustion Engines, Gas Turbines, and Generators.....	64
4-38.4	Indoor Transformers.....	64
4-38.5	Outdoor Transformers.....	64
4-39	\5\PRIVACY PODS OR PRIVACY ENCLOSURES.....	67
4-39.1	Sprinkler Protection.....	67
4-39.2	Fire alarm.....	68
4-39.3	Life Safety.....	68
4-40	RANGES AND REMOTE LOCATIONS.....	68
4-40.1	\2\Water Supply.....	68
4-40.2	\4\Facilities.....	68
4-40.3	Fire Department Vehicle Access.....	68
4-41	RELOCATABLES.....	68
4-41.1	General.....	68
4-41.2	Location.....	69
4-42	SENSITIVE COMPARTMENTED INFORMATION FACILITY (SCIF)....	69
4-42.1	General.....	69
4-42.2	Physical Security Door Hardware.....	69
4-42.3	Fire Alarm and Mass Notification System (MNS).....	69
4-42.4	Fire Sprinkler Systems.....	70
4-43	TENSIONED-MEMBRANE STRUCTURES.....	70
4-43.1	General.....	70
4-43.2	/5/Allowable Area and Separation Distance.....	70
4-43.3	Tensioned-Membrane (Fabric) Hangars.....	71
4-44	TRASH/RECYCLING COLLECTION AND DISPOSAL AREAS.....	71
4-44.1	Central Trash/Recycling Collection and Dumpsters.....	71
4-44.2	Collection, Baling, Processing and Storage Rooms.....	71
4-44.3	Trash/Recycling Chutes.....	71
4-45	VEHICLE PARKING, STORAGE, MAINTENANCE, AND REPAIR FACILITIES.....	72
4-45.1	General.....	72
4-45.2	Refueler Vehicle Facilities.....	72

4-46	WAREHOUSE AND STORAGE FACILITIES.	72
4-46.1	General.	72
4-46.2	Sprinkler Protection.	72
4-46.3	Bin Storage.	73
4-46.4	Column Protection.	74
4-46.5	<i>Fire Areas.</i>	74
4-46.6	Conveyor and Mechanical Handling System Penetrations.	74
4-47	WATERFRONT FACILITIES.	75
4-48	WILDLAND-URBAN INTERFACE LOCATIONS.	75
4-48.1	General.	75
CHAPTER 5 GENERAL BUILDING HEIGHTS AND AREAS		77
5-1	GENERAL.	77
5-2	BUILDING HEIGHT LIMITATIONS.	77
5-3	BUILDING AREA LIMITATIONS.	77
5-4	OCCUPANCY SEPARATION.	77
5-4.1	General.	77
5-5	INCIDENTAL USE.	77
CHAPTER 6 TYPES OF CONSTRUCTION		79
6-1	GENERAL.	79
6-2	SEPARATION BETWEEN BUILDINGS.	79
CHAPTER 7 FIRE AND SMOKE PROTECTION FEATURES		81
7-1	GENERAL.	81
7-2	MARKING AND IDENTIFICATION.	81
7-3	NON-LOAD BEARING PARTITIONS AND BARRIERS.	81
7-4	PROTECTION OF STRUCTURAL MEMBERS.	81
7-4.1	General.	81
7-4.2	Sprayed Fire-Resistant Materials.	81
7-4.3	Ceilings.	82
7-5	SMOKE AND HEAT VENTS.	82
7-5.1	General.	82
7-6	HIGH VOLUME LOW SPEED (HVLS) FANS.	82
7-7	PLASTIC PIPE AND CONDUIT.	82

7-7.1	Penetrations.....	82
7-7.2	Prohibited Locations.	82
CHAPTER 8 INTERIOR FINISHES		83
8-1	GENERAL.	83
8-2	DROP-OUT PANELS.	83
8-3	INSULATION.....	83
8-3.1	Requirements.	83
8-3.2	Exceptions to Insulation Criteria.	83
CHAPTER 9 FIRE PROTECTION SYSTEMS		85
9-1	FIRE DEPARTMENT (EMERGENCY) VEHICLE ACCESS.....	85
9-1.1	All-Weather Ground Access.....	85
9-1.2	Aerial Apparatus Access.....	85
9-1.3	Vehicle Access.	85
9-1.4	Fire Department Connection.....	85
9-2	<i>FIRE FLOW FOR FACILITIES.....</i>	86
9-2.1	Sprinklered <i>Facilities</i>	86
9-2.2	Non-sprinklered <i>Facilities</i>	86
9-2.3	\3\Family Housing.	86
9-3	<i>SERVICE MAINS AND LATERALS.....</i>	87
9-3.1	General.....	87
9-3.2	<i>Service Mains</i>	87
9-3.3	<i>Service Laterals</i>	87
9-3.4	Valves.....	88
9-3.5	Fire Hydrants.	88
9-3.6	Pressure-Regulating Valves (PRVs).....	90
9-4	<i>FACILITY ON-SITE WATER STORAGE.....</i>	91
9-4.1	General.....	91
9-4.2	Quantity.	91
9-4.3	Replenishment of Storage.	91
9-4.4	Monitoring.....	91
9-5	FIRE PUMPS.....	91
9-5.1	General.....	91

9-5.2	Pump Type.	93
9-5.3	Pump Start and Shutdown.	93
9-5.4	Pump Drive.	93
9-5.5	Controllers.	94
9-5.6	Pump Bypass.	94
9-5.7	Electric Circuits for Diesel Engine Driven Pumps.	94
9-5.8	Test Connections.	94
9-6	FIRE SUPPRESSION SYSTEMS.	94
9-6.1	General.	94
9-6.2	Connections to <i>Fire Alarm Reporting Systems</i>	95
9-6.3	Plans and Calculations.	95
9-6.4	Waterflow Testing.	96
9-6.5	<i>Fire Water Demand</i>	96
9-6.6	Backflow Prevention and Cross Connection Control.	96
9-6.7	Meters.	97
9-6.8	Painting and Labeling.	97
9-7	AUTOMATIC SPRINKLER SYSTEMS.	98
9-7.1	General.	98
9-7.2	Application Requirements.	98
9-7.3	Design Requirements.	99
9-7.4	Sprinkler Coverage.	100
9-7.5	Hydraulic Calculations.	101
9-7.6	Piping.	101
9-7.7	Nitrogen Generation Systems.	102
9-7.8	Preaction Systems.	102
9-7.9	Dry Pipe Systems.	103
9-7.10	System Requirements.	103
9-7.11	Family Housing.	104
9-8	WATER SPRAY SYSTEMS.	105
9-9	FOAM SYSTEMS.	105
9-9.1	General.	105
9-9.2	Piping.	105

9-9.3	Aqueous Film-Forming Foam (AFFF) \4\System/4/	105
9-9.4	Foam Concentrate Pumps.....	106
9-9.5	Foam Concentrate Storage Tanks.....	106
9-9.6	Foam Concentrate Control Valves.....	106
9-9.7	Foam Concentrate Spill Control.....	106
9-9.8	Test Liquid.....	106
9-9.9	Foam Discharge.....	107
9-10	STANDPIPE SYSTEMS.....	107
9-10.1	General.....	107
9-10.2	Class I Standpipe Systems.....	107
9-10.3	Class II and III Standpipes.....	107
9-11	DRY CHEMICAL EXTINGUISHING SYSTEMS.....	107
9-11.1	General.....	107
9-11.2	Limitations.....	108
9-12	WET CHEMICAL EXTINGUISHING SYSTEMS.....	108
9-12.1	General.....	108
9-12.2	Testing.....	108
9-13	CLEAN AGENT FIRE EXTINGUISHING SYSTEMS.....	108
9-13.1	General.....	108
9-13.2	Requirements.....	108
9-14	WATER MIST FIRE PROTECTION SYSTEMS.....	109
9-14.1	General.....	109
9-15	CARBON DIOXIDE SYSTEMS.....	109
9-15.1	General.....	109
9-16	HALON 1301 SYSTEMS.....	110
9-16.1	General.....	110
9-16.2	Halon Turn-In Procedures.....	110
9-17	PORTABLE FIRE EXTINGUISHERS.....	110
9-17.1	General.....	110
9-17.2	Location.....	110
9-18	/2/FIRE ALARM SYSTEMS.....	110
9-18.1	General.....	110

9-18.2	Plans and Calculations.	111
9-18.3	<i>Fire Alarm Reporting System</i>	111
9-18.4	Control Panels.	112
9-18.5	Detection.....	113
9-18.6	Notification.	113
9-18.7	Initiating Devices.....	115
9-18.8	Power Disconnect.....	116
9-18.9	Wiring, Circuits and Conduit.	116
9-18.10	Surge Suppression.	118
9-18.11	Power.....	118
9-18.12	Releasing Control Panels.	118
9-19	CARBON MONOXIDE (CO) DETECTION.	119
9-19.1	General.....	119
9-19.2	Installation.....	119
9-19.3	Notification.	119
9-20	SMOKE CONTROL SYSTEM	120
9-20.1	General.....	120
9-20.2	Installation.....	120
9-20.3	Testing.	121
CHAPTER 10 MEANS OF EGRESS		123
10-1	GENERAL.	123
10-1.1	Requirements.	123
10-1.2	Accessible Means of Egress.....	123
10-2	MEANS OF EGRESS MARKING.....	123
10-2.1	Requirements.	123
10-2.2	Radioluminous Exit Signs.	123
10-2.3	Photoluminescent Exit Signs and Markings.....	123
10-3	OCCUPANT LOAD.	124
10-3.1	Occupant load factors.....	124
10-3.2	Maximum occupant load.....	125
10-4	STAIR TO ROOF ACCESS.....	125
10-5	COMMUNICATING SPACE	125

CHAPTER 11 ACCESSIBILITY	127
11-1 GENERAL	127
CHAPTER 12 INTERIOR ENVIRONMENT	127
12-1 GENERAL	127
CHAPTER 13 ENERGY EFFICIENCY	127
13-1 GENERAL	127
CHAPTER 14 EXTERIOR WALLS	127
14-1 GENERAL	127
CHAPTER 15 ROOF ASSEMBLIES AND ROOFTOP STRUCTURES	127
15-1 ROOF COVERINGS	127
15-2 ROOF DECK ASSEMBLIES	127
15-2.1 General	127
CHAPTER 16 STRUCTURAL DESIGN	128
16-1 GENERAL	128
CHAPTER 17 SPECIAL INSPECTIONS AND TESTS	128
17-1 GENERAL	128
CHAPTER 18 SOILS AND FOUNDATIONS	128
18-1 GENERAL	128
CHAPTER 19 CONCRETE	129
19-1 GENERAL	129
CHAPTER 20 ALUMINUM	129
20-1 GENERAL	129
CHAPTER 21 MASONRY	129
21-1 GENERAL	129
CHAPTER 22 STEEL	129
22-1 GENERAL	129
CHAPTER 23 WOOD	129
23-1 FIRE RETARDANT TREATED (FRT) WOOD	129
CHAPTER 24 GLASS AND GLAZING	129
24-1 GENERAL	129
CHAPTER 25 GYPSUM BOARD, GYPSUM PANEL PRODUCTS AND PLASTER .	130
25-1 GENERAL	130

CHAPTER 26 PLASTIC.....	130
26-1 GENERAL.....	130
CHAPTER 27 ELECTRICAL	130
27-1 GENERAL.....	130
CHAPTER 28 MECHANICAL SYSTEMS.....	130
28-1 AIR HANDLING.....	130
28-1.1 General.....	130
28-1.2 Plenums.....	130
28-1.3 Computer Room Air Conditioning (CRAC).....	131
CHAPTER 29 PLUMBING SYSTEMS.....	131
29-1 GENERAL.....	131
CHAPTER 30 ELEVATORS AND CONVEYING SYSTEMS.....	131
30-1 GENERAL.....	131
CHAPTER 31 SPECIAL CONSTRUCTION.....	131
31-1 GENERAL.....	131
CHAPTER 32 ENCROACHMENTS INTO THE PUBLIC RIGHT-OF-WAY	131
32-1 GENERAL.....	131
CHAPTER 33 SAFEGUARDS DURING CONSTRUCTION	131
33-1 GENERAL.....	131
CHAPTER 34 EXISTING FACILITIES.....	133
34-1 GENERAL.....	133
34-1.1 Minimum Requirements.....	133
34-1.2 \2V2/Work in Existing Facilities.....	133
34-1.3 /5/Change in Use.....	135
34-1.4 Vacant Buildings.....	136
34-2 PHASED PROJECTS.....	136
34-2.1 General.....	136
34-3 COOKING AREAS.....	137
34-4 DETENTION AND CORRECTIONAL FACILITIES.....	137
34-5 ELECTRONIC EQUIPMENT AREAS.....	137
34-6 FAMILY HOUSING.....	137
34-6.1 Projects that exceed 50 percent of the Replacement Cost.....	137

34-6.2	Projects that are less than 50 percent of the Replacement Cost.	137
34-7	FIRE PROTECTION SYSTEMS.....	138
34-7.1	General.....	138
34-8	FIRE ALARM SYSTEMS.....	138
34-8.1	General.....	138
34-9	HAZARDOUS MATERIALS.....	138
34-10	PERSONNEL HOUSING.....	138
34-10.1	\5\Common Areas.....	138
34-10.2	Air Force.....	139
34-11	ROOF COVERINGS.....	139
APPENDIX A REFERENCES.....		141
APPENDIX B OCCUPANCY HAZARD CLASSIFICATION FOR DETERMINING AUTOMATIC SPRINKLER DENSITIES AND HOSE STREAM DEMANDS		151
B-1	CLASSIFICATION OF OCCUPANCIES.....	151
B-1.1	Light Hazard Occupancies.....	151
B-1.2	Ordinary Hazard Occupancies.....	151
B-1.3	Extra Hazard Occupancies.....	152
B-1.4	Special Occupancies.....	153
APPENDIX C PROCEDURE FOR PERFORMANCE-BASED FIRE SAFETY DESIGN		155
C-1	EQUIVALENT LEVEL OF SAFETY AND PROTECTION.....	155
C-2	FIRE SAFETY DESIGN DOCUMENTATION.....	155
C-2.1	Fire Protection Engineering Design Brief.....	155
C-2.2	Performance-Based Fire Safety Design Report.....	158
C-2.3	Building O&M Documentation.....	158
C-2.4	Warrant of Fitness.....	158
C-3	REVIEW OF TRIAL DESIGNS.....	158
C-3.1	Review Brief.....	159
C-3.2	Third Party Review.....	159
C-3.3	Compliant Fire Safety Design.....	159
APPENDIX D INTERNATIONAL BUILDING CODE AND NFPA 220 EQUIVALENTS		161

APPENDIX E RECOMMENDED FIRE ALARM AND EMERGENCY NOTIFICATION MESSAGES	163
APPENDIX F ABBREVIATIONS AND ACRONYMS.....	173
APPENDIX G \3\ CRITERIA FOR PROJECTS IN JAPAN	179

FIGURES

Figure 4-1 Examples of Weather Covering	27
Figure 4-2 Electric Traction Elevator	38
Figure 4-3 Direct Plunger Hydraulic Elevator	39
Figure 4-4 Holeless and Roped Hydraulic Elevator.....	40

TABLES

Table 3-1 Hazardous Materials Classification.....	24
Table 4-1 Electric Traction Elevator.....	36
Table 4-2 Direct Plunger Hydraulic Elevator	37
Table 4-3 Holeless Hydraulic and Roped Hydraulic Elevator	37
Table 4-4 Separation Distance Between Outdoor Insulated Transformers and Buildings.....	66
Table 4-5 Separation Distance Between Outdoor Fluid Insulated Transformers and Equipment (Including Other Transformers).....	67
Table 4-6 Basic Allowable Area for Tensioned-Membrane/Fabric Structures	71
Table 9-3 Sprinkler Design Demand and Minimum K-Factor	100
Table 9-4 Hose Stream Demand and Duration.....	100

Table 10-1 Supplemental Occupant Load Factors 124

CHAPTER 1 INTRODUCTION

1-1 SCOPE AND ADMINISTRATION.

This UFC establishes fire protection engineering policy and criteria for Department of Defense Components (*DoD Components*). These criteria are based on commercial requirements set forth by national insurance underwriters and may exceed minimum national code requirements. The requirements in this UFC reflect the need for the protection of life, mission continuity, and property (building or contents) while taking into account the costs of implementing the criterion and risks associated with the *Facility*. These criteria have been established in the best interest of DoD.

1-2 APPLICABILITY.

1-2.1 General.

1-2.1.1 The provisions of this UFC are applicable to all new and existing DoD *Facilities* located on or outside of DoD *Installations*, within the United States and its territories and possessions or outside the United States and its territories and possessions, whether owned or leased, by appropriated or non-appropriated funds, or third party financed and constructed.

1-2.1.2 The provisions of this UFC are applicable to all types of *Facilities* and their contents, structures, whether considered permanent, semi-permanent or temporary construction, mobile and stationary equipment, civil works or military facilities, hydroelectric plants, waterfront facilities, outside storage, and shore protection for ships and aircraft. As required by DoDI 4165.56, these provisions are applicable to any structure that is used to provide the same capabilities as real property acquired facilities and structures.

1-2.1.3 Projects outside the United States and its territories and possessions must comply with provisions of this UFC and the host nation fire protection requirements. For conflicts between this UFC and the host nation fire protection requirements, the *AHJ* must be consulted.

1-2.1.3.1 For projects in Japan, see specific mandatory requirements in Appendix G: "Criteria for Projects in Japan".

1-2.2 Acronyms, Abbreviations, Defined Terms, and Referenced Criteria.

Acronyms and abbreviations used within this UFC are defined in Appendix F. The full name of referenced criteria, codes or standards can be found in Appendix A. Terms defined in Chapter 2 are italicized in this UFC.

1-2.3 Fire Department Operations.

Matters relating to fire department operations, staffing and firefighting equipment are outside the scope of this UFC.

1-3 PURPOSE.

This UFC must be used as the minimum standard for the planning and development of projects and, design, construction and commissioning documentation used for the procurement of Facilities. Examples include, but are not limited to, the development of scopes of work, DD1391 documentation, drawings, specification and request for proposals. It is the primary fire protection criteria reference document for services provided by architectural and engineering (A&E) firms and consultants in the development of both design-bid-build and design-build contracts. It is not intended to be used in lieu of detailed design documents in the procurement of *Facility* construction.

1-4 CRITERIA.

1-4.1 Federal Laws.

This UFC complies with all applicable Federal laws, including but not limited to:

UNITED STATES CODE <http://uscode.house.gov/>.

- a. USC Title 10, Chapter 8, Subchapter II, Military Child Care.
- b. USC Title 15, Section 272 Utilization of Consensus Technical Standards by Federal Agencies.
- c. USC Title 15, Section 2225 Hotel-Motel Fire Safety.
- d. USC Title 15, Section 2227 Fire Administration Authorization Act (also referred to as the Fire Safety Act).
- e. USC Title 42, Section 4151 Architectural Barriers Act of 1968.

1-4.2 DoD Criteria.

1-4.2.1 UFC 3-600-01 supplements the requirements listed in UFC 1-200-01. UFC 3-600-01 supersedes NFPA and other industry standards, except where not specifically addressed by this UFC.

1-4.2.2 Features in excess of the requirements in this UFC must be approved by the *Authority Having Jurisdiction (AHJ)*.

1-4.2.3 Where the IBC references the International Fire Code (IFC), the IFC must be replaced with NFPA 1, except where superseded by this UFC.

1-4.2.4 For leased *Facilities*, the criteria in this UFC must apply, unless it is determined by the *DFPE* it is not in the best interest of DoD. For conflicts between this UFC and the local municipal jurisdiction, the *DFPE* must be consulted.

1-4.2.5 Individual *DoD Components* issue specific technical guidance that expands the requirements of this UFC. For example, the Air Force issues engineering technical letters (ETLs); and the Army and Navy/Marines issue engineering construction bulletins (ECB).

- a. For Army, Air Force, Navy/Marines, see <http://dod.wbdg.org/>.
- b. For Washington Headquarters Service (WHS), see WHS Building Code, <http://www.wbdg.org/ccb>

1-4.2.6 Where criteria are not included in this UFC, fire protection criteria must conform to the requirements of the latest editions of the National Fire Codes. Where criteria are not available from the National Fire Codes, a fire protection design analysis must be submitted to the *DFPE* for approval.

1-4.3 Standards, Codes and Guides.

Fire protection criteria must conform to the requirements of standards, codes and guides as modified or referenced in this UFC. The primary references include, but are not limited to, the most recent editions of the following:

- a. National Fire Codes, published by the National Fire Protection Association (NFPA).
- b. FM Global (<http://www.fmglobal.com/>) Property Loss Prevention Data Sheets, as referenced by this UFC.

Note: NFPA 5000, state or local building or fire codes must not be used.

1-4.4 Antiterrorism and Security Standards.

Antiterrorism and security requirements noted in UFC 4-010-01, UFC 4-020-01 and other 4 series UFCs must not preclude any fire protection requirements. This UFC will be in coordination with the ATFP sections as noted in the other 4 series UFCs.

1-5 GENERAL BUILDING REQUIREMENTS.

Comply with UFC 1-200-01, general building requirements. UFC 1-200-01 provides applicability of model building codes and government unique criteria for typical design disciplines and building systems, as well as for accessibility, antiterrorism, security, high performance and sustainability requirements, and safety. Use this UFC in addition to UFC 1-200-01 and the UFCs and government criteria referenced therein.

1-6 REFERENCES AND DATES OF PUBLICATION.

1-6.1 General.

Appendix A contains a list of references used in this document. The publication date of codes or standards are not included in this document. Unless modified by UFC 1-200-01, this document or the applicable contract, the latest available issuance of a reference must be used.

1-6.2 Project Delays.

For projects that have a delay, as defined in UFC 1-200-01, the *DFPE* has the responsibility to determine if design revisions are required based on an analysis performed by the *Qualified Fire Protection Engineer (QFPE)*.

1-7 FIRE PROTECTION ENGINEERING SERVICES.

1-7.1 General.

1-7.1.1 *Major Projects* require the design, review and oversight services of a *QFPE*. A *QFPE* must be involved in every aspect of the design, construction and testing/commissioning as it relates to fire protection and life safety. This includes, but is not limited to, building code analysis, life safety code analysis, design of automatic fire alarm, detection and suppression systems, water supply analysis, a multi-discipline review of the entire project, construction inspections and witnessing of fire protection acceptance testing/commissioning.

Note: Utilization of multiple *QFPEs* on the same project is permitted, but not preferred.

1-7.1.2 This requirement is applicable to engineering services for design-bid-build projects as well as all phases of design-build projects including RFP development, design development, and construction.

1-7.1.3 For the purpose of this UFC, the *QFPE* must submit, upon request, a written copy of their resume indicating education, professional registration and work experience, along with a letter attesting to their compliance with the requirements of this Section. The letter must include an imprint of their professional engineering stamp with signature.

1-7.2 Fire Protection Design Analysis and Life Safety Plans.

1-7.2.1 A fire protection design analysis and life safety plans must be provided for all *Major Projects* and must address the fire protection requirements of the project as required by this UFC. The fire protection design analysis and life safety plans must be submitted with the initial design submission, separate from other disciplines. The final design analysis and life safety plans must be signed and sealed by the *QFPE*.

Note: When directed by the *DFPE*, projects with little or no fire protection considerations may not require a fire protection design analysis or life safety plans.

1-7.2.2 Fire Protection Design Analysis.

Where applicable, discuss the following minimum fire protection provisions (include required vs. provided):

- a. Identification of all fire protection and life safety related codes and standards applicable to the project, including the edition. This includes Host Nation requirements.
- b. Building code analysis (e.g., type of construction, height and area limitations, building separation, exposure protection, etc.).
- c. Classification of occupancy (both IBC and NFPA 101).
- d. Requirements for fire walls, fire barriers, fire partitions, smoke barriers and smoke partitions, compartmentation and special hazard protection (both horizontal and vertical). Include the associated fire resistance rating.
- e. Requirements for protection of horizontal and vertical penetrations and openings as well as the associated fire resistance rating.
- f. Separation from hazards per NFPA 101.
- g. Interior finish ratings.
- h. Means of egress provisions and components (occupant load, exit capacity, exit width, travel distance, common path of travel, dead-end corridors, use of suites, etc.).
- i. Water supplies, water distribution, location of fire hydrants, Fire Flow calculations.
- j. Location of fire department connections (FDCs).
- k. Location of post indicator valves (PIVs) and other control or isolation valves.
- l. Analysis of automatic sprinkler and suppression systems and protected areas. Include supporting calculations used to establish system performance requirements such as hydraulic analysis of water demand or agent concentration and quantity.
- m. Standpipe systems.
- n. Portable fire extinguishers.
- o. Fire detection (the type of detection and type/location of detectors).

- p. Fire alarm system (the type of alarm system, location of the fire alarm equipment and mass notification).
- q. Smoke management or control methods.
- r. Connection to and description of base Fire Alarm Reporting System.
- s. Coordination with security and antiterrorism requirements, including connection to Installation-wide Mass Notification System.
- t. Fire department access.
- u. AHJ approved equivalencies \1V1/ (see the paragraph entitled "Equivalencies" below).
- v. For projects not within the United States or its territories, identify code/criteria conflicts and AHJ approved design solutions\1\ or/1/ equivalencies \1V1/to DoD or Host Nation criteria necessary to resolve. The analysis must also identify the associated impact on project cost.
- w. Initial, or draft, integrated performance verification and testing plan(s) where multiple systems across multiple trades rely on an integrated operation to perform the desired result.

1-7.2.3 Life Safety.

Where applicable, the following minimum fire protection provisions must be included on the life safety plans:

- a. All minimum fire protection provisions listed above, on a separate code summary sheet.
- b. Capacity and number of occupants using each major means of egress component (e.g., stairs, stair doors, exterior doors, assembly exit doors).
- c. Maximum travel distance, dead-end corridor, common path of travel, accessible means of egress and exit components for each floor and occupancy classification. When suites are used, indicate type, location, area and arrangement.
- d. IBC and NFPA occupancy classification of each room, area or compartment (on the drawings or in tabular form). Include occupant load of each room, area or compartment. Similar occupancies can be grouped together for occupant load calculations.
- e. Location and rating of all fire walls, fire barriers, fire partitions, smoke barriers and smoke partitions (both horizontal and vertical). Barriers requiring fire resistance rated supporting construction must be specifically identified for coordination with the structural design.

- f. Location of hazardous materials storage, handling and use that exceed the maximum allowable quantities.
- g. Structural fireproofing locations and associated ratings.

1-7.2.4 Code Compliance Plans.

1-7.2.4.1 Code Compliance Summary Sheet.

Provide the building code and life safety code analyses included in the \4\ fire protection design analysis/4/. Specifically call out any approved criteria exemptions. For projects outside the United States and its territories and possessions, identify code/criteria conflicts and proposed design solutions to resolve.

1-7.2.4.2 Code Compliance Site Plan.

Where applicable, the following minimum fire protection provisions must be included on the Code Compliance Site Plan:

- a. Line of encroachment identifying assumed property lines and minimum separation distances from adjacent buildings.
- b. Building perimeter used for frontage increases.
- c. Fire department access.
- d. Fire lane width, marking and locations, approach roads and turn radius and location.
- e. Type and quantity of antiterrorism secure access.
- f. Intended fire department main entrance to facility.
- g. Location of fire department connections.
- h. Fire hydrants, post indicator valve or valves and their connected water distribution mains serving facility.
- i. Fire pump room.
- j. Water storage tanks.
- k. Hazardous material spill containment tanks.
- l. Backflow prevention assembly or assemblies serving water-based fire protection systems (if located outside of building).

1-7.2.5 Preliminary Hydraulic Analysis.

1-7.2.5.1 Prepare a preliminary hydraulic analysis to demonstrate that the anticipated water demand(s), including those for fire, domestic, and industrial needs, will be satisfied by the available water supply. This analysis must include an estimate for the minimum required capacity of water, along with minimum volumetric waterflow rate and water pressure, with all assumptions clearly defined and referenced and must demonstrate that the available water supply is capable of meeting the required water demands in any project. Include a graphical analysis of the relationship between the *Fire Water Demand* and the available water supply.

1-7.2.5.2 For design-build projects, prepare the preliminary hydraulic analysis prior to advertisement of the request for proposal.

1-7.3 Final Design Submission.

The *QFPE* must review the complete 100 percent design drawings and specification submission (all disciplines) and document in writing that the design is in compliance with this UFC and all applicable fire protection and life safety design criteria. The review must provide verification that all items listed in the design analysis are correctly shown on the drawings and in the specification and list any approved equivalencies or deviations from this UFC. This design compliance document must be submitted with the final design submission as part of the design analysis and must bear the signature and professional seal of the *QFPE*.

1-7.4 Host Nation.

For projects outside the United States and its territories and possessions, a Host Nation Code Compliance certification must be performed by a Host Nation fire protection consultant. For each item of conflict or nonconformance with the Host Nation codes, the certification must include the following:

- a. Item of conflict.
- b. Translation of Host Nation requirement to the English language.
- c. Recommended resolution.
- d. Additional costs, both engineering effort to prepare the design modification and estimated construction costs.

1-8 **EQUIVALENCIES.**

Alternative design approaches proposed as equivalencies to established criteria must be approved by the *AHJ*. Requests for approval must include written justification for the deviation from established criteria and demonstrate how the proposed alternative solution provides an equivalent level of fire protection and life safety. Requests must also include hazard analysis, compensatory features, comparative cost analyses (first cost and life cycle cost), criteria used, and other pertinent data. Lack of funds is not considered sufficient justification for an equivalency to established criteria. Approved

equivalencies and alternatives apply only to the specific *Facility* or project involved, and do not constitute blanket approval for similar cases.

1-9 EXEMPTIONS.

Exemptions to established criteria must be submitted to the \1\Service Signature Authority/1/ for determination. The *exemption* must demonstrate that the criteria cannot be technically executed, or execution of the criteria will increase a hazard or create a new hazard and no technical alternatives exist. Written request for exemptions must include justification, hazard analysis, cost comparison, alternatives considered, and other pertinent data. Lack of funds or cost savings are not considered sufficient justification for deviation from established criteria. *Exemptions* will only apply to the specific *Facility* or project involved and do not constitute blanket approval for similar cases. *Exemptions* must follow the process outlined in MIL-STD-3007.

1-10 PERFORMANCE-BASED FIRE SAFETY DESIGN.

1-10.1 General.

1-10.1.1 The use of performance-based fire safety design methods may only be permitted upon authorization by the *AHJ*.

1-10.1.2 Performance-based fire safety design must comply with the procedures, provisions and applicable requirements of Appendix C.

Note: Appendix C is in accordance with the performance-based option of NFPA 101 and the performance-based fire safety design approach of the Society of Fire Protection Engineers (SFPE), Introduction to Performance-Base Fire Safety.

1-10.1.3 A *QFPE* must perform the performance-based fire safety design.

1-10.2 Application.

1-10.2.1 Performance-based fire safety design methods may not be used to eliminate required exiting requirements of NFPA 101, nor may it be used to eliminate automatic sprinkler systems required by DoD criteria.

1-10.2.2 The use of performance-based fire safety design will only be considered for the following:

1-10.2.2.1 Existing facilities where it is not feasible to meet prescriptive requirements of this UFC.

1-10.2.2.2 New facilities for which established prescriptive criteria does not exist.

1-11 FIRE PROTECTION DURING CONSTRUCTION.

Contract specifications must reference the USACE Engineering Manual (EM), EM-385-1-1 and NFPA 241 and must contain the requirement that the *Installation's* fire regulations be followed.

1-12 PLANNING\2\ (CONTRACT DOCUMENT DEVELOPMENT)/2/.

1-12.1 General.

1-12.1.1 The criteria in this UFC must be used in project planning or the development of projects \2\and contract documents/2/. The information in this section must be reviewed during the planning phase to verify that adequate *Installation* infrastructure exists.

1-12.1.1.1 It is DoD's responsibility to determine whether or not the *Installation* infrastructure is adequate to support the project.

Note: Examples of infrastructure include water supply and fire department access.

1-12.1.2 The requirement for a *QFPE* must be included in the statement of work for design services as well as design/build services.

1-12.2 *Installation* Water Supply.

1-12.2.1 The quantity of water required is equal to the greater of the largest *Fire Water Demand* or *Fire Flow* for the required duration. This quantity represents fire water supply requirements only, that must be available at all times. Water supply for domestic, industrial, and other demands must be added to these requirements to determine the total amount of water required at an *Installation*.

1-12.2.2 The water supply analysis must include an analysis of the domestic water quantity using diurnal curves if time of day water curves are not available. The analysis must include historical data to address seasonal water supply fluctuations, peak water demand and average daily demand and its effect on fire suppression water availability.

1-12.3 *Installation* Water Distribution.

Note: The requirements of this section apply to the *Installation*, as defined in Chapter 2, not the individual *Facility*.

1-12.3.1 Except as modified below, water distribution mains, service mains and service laterals must be designed in accordance with AWWA M31, NFPA 24 and UFC 3-230-01.

1-12.3.2 \2\For *service laterals* that do not utilize PVC pipe, the velocity must not exceed 10 feet per second (3 m/s).

1-12.3.3 /2/One or more of the following reliable means must provide fire protection water to an *Installation*:

1-12.3.3.1 Multiple connections to looped or gridded public *Service Main(s)* arranged so that during any single-point failure, at least 50 percent of the maximum required *Fire Flow* plus 100 percent of domestic demand can still be supplied to the *Installation*.

1-12.3.3.2 A single connection to a public *Service Main(s)*, plus on-site storage sized in accordance with UFC 3-230-01, in the event the connection to the public system is lost.

1-12.3.3.3 One or more on-site sources, such as wells or open bodies of water, with treated water storage capacity sized in accordance with UFC 3-230-01.

1-12.3.4 For a small *Installation*, such as a Reserve Training Center, a single connection to a looped or gridded public water *Service Main*, capable of providing concurrent domestic demand and *Fire Flow* to the *Installation*, is acceptable.

1-12.3.5 For service mains served by fire pumps or service laterals serving fire pumps, velocities must be calculated using 150 percent of the rated capacity of the fire pump.

1-12.4 *Installation* On-Site \2\Water/2/ Storage.

\2\2/

1-12.4.1 Water level must be remotely monitored in accordance with NFPA 22 and NFPA 72 at a constantly attended location, preferably at the *Installation's* remote supervising station.

1-12.4.2 In geographic locations having a 99.6% dry bulb temperature less than 32°F (0°C) per UFC 3-400-02 Engineering Weather Data, water temperature of aboveground storage tanks must likewise be monitored at a constantly attended location.

1-12.4.3 Provide an external visual water-level gauge on each non-elevated or below ground tank.

1-12.5 Waterflow Testing.

1-12.5.1 Conduct waterflow tests, in accordance with the procedures contained in NFPA 291, to determine available water supply for the water-based fire extinguishing systems. The flow test must be performed under the direction of the *DFPE*. Advertisement of the project must not occur without obtaining water supply information.

1-12.6 *Fire Flow.*

1-12.6.1 *Fire Flow* for any proposed *Facility* must be calculated to determine if upgrades to the *Installation* water supply is required. *Fire Flow* must be calculated in accordance with Chapter 9.

1-12.6.1.1 Where the *Fire Flow* cannot be met, the *DFPE* is permitted to approve a reduction in *Fire Flow*.

1-12.6.2 When the required *Fire Flow* cannot be provided by the existing infrastructure, a cost and benefit analysis must be conducted by the *DFPE*, or their representative, to determine if additional fire protection systems, features, or design changes that provide more favorable factors, such as type of construction or sprinkler protection, are more cost effective than providing the required *Fire Flow*.

1-12.7 *Fire Pumps.*

1-12.7.1 The *DFPE* must determine the need for a fire pump in the planning stages of a project in order to ensure adequate space is available at the *Facility*.

1-12.7.2 The *DFPE* must determine if a *Reliable Power Source* is available to the *Installation* or *Facility* in the planning stages of the project in order to ensure that the cost and space associated with secondary power is considered and included in the project.

1-12.7.3 \2\Where a fire pump is needed, a single pump is satisfactory for ordinary value and ordinary use structures. For structures with critical missions or very high values, the AHJ may require redundancy in fire pump capacity such, as two pumps at 100% capacity or three pumps at 50% capacity. /2/

1-12.8 *Automatic Sprinkler Systems.*

1-12.8.1 \2\For facilities that do not require sprinkler protection as required in the “Special Detailed Requirements Based On Use” or “Fire Protection Systems” chapters of this UFC,/2/ the *DFPE* must determine if an automatic sprinkler or other fire suppression system is required for the *Facility* based on mission, hazard of contents, value of contents or other criteria. This determination must be included in the contract documents for design services or design-build services.

1-12.8.2 Prior to the installation of backflow preventers in an existing fire suppression system, a thorough hydraulic analysis, including hydraulic calculations and flow test, must be performed to ensure that the water supply is still adequate for the system with the backflow preventer. If the backflow preventer causes the demand to exceed the water supply, the backflow preventer must not be installed until the water supply is corrected to support the new demand.

1-12.9 *Clean Agent Fire Extinguishing Systems.*

The *DFPE* must determine if a connected reserve supply should be provided.

Note: A reserve supply should only be considered if replacement cannot be delivered to the site within 24 hours. This would typically apply to locations outside the United States and its territories and possessions.

1-12.10 Rural, Remote, \3\and Range/3/ Locations.

Fire protection water supplies supporting rural, remote, \3\or range/3/ *Facility* locations without water distribution systems must be in accordance with NFPA 1141 and NFPA 1142.

1-12.11 Military Operations on Urban Terrain (MOUT) Trainers.

1-12.11.1 See the paragraph entitled "MOUT" in the "Special Detailed Requirements Based on Use" Chapter in this UFC.

1-12.12 Warehouses and Storage *Facilities*.

1-12.12.1 The DFPE must determine if sprinkler protection must be provided for *facilities* less than 5,000 square feet containing materials, equipment and supplies that are critical to operations, pose a severe fire hazard, are of high monetary value, pose a safety or environmental health risk, or expose an important structure.

1-12.12.2 The DFPE must determine the commodity classification and maximum storage height and include this information in the contract documents when this information differs from the minimum noted in the section on "Warehouse and Storage *Facilities*" in this UFC.

1-12.12.3 \2\Information such as the storage configuration (racks, shelves, palletized, bin box, and solid-piled), aisle width, clearance to ceiling, and ceiling sprinkler temperature rating must be evaluated prior to developing contract documents in order to provide the proper sprinkler protection./2/

1-12.12.4 See the section on "Warehouse and Storage *Facilities*" in this UFC for additional requirements.

1-12.13 Existing *Facilities*.

1-12.13.1 When planning any \5\ work /5/ to existing facilities, determine if the facility has any existing or outstanding fire protection or life safety deficiencies and include them into the work being planned.

1-12.13.2 If work is being phased, the total floor area of all the phased work must be used to determine if the facility needs to be brought into compliance with new criteria in lieu of just the work being performed. See the section for "Phased Projects" in this UFC.

1-12.13.3 See the "Existing Facilities" Chapter in this UFC for additional requirements.

1-13 **CYBERSECURITY.**

All control systems (including systems separate from an energy management control system) must be planned, designed, acquired, executed, and maintained in accordance with DoD Instruction 8500.01, DoD Instruction 8510.01, and as required by individual Service Implementation Policy.

CHAPTER 2 DEFINITIONS

2-1 GENERAL.

The definitions contained in this chapter apply to the terms used in this UFC. Where terms are not defined in this chapter or within another chapter, they are defined in the referenced UFC, code or standard applicable to the context in which they are used. Plural terms must have the same definition as singular terms.

2-1.1 Addition.

An increase in the building area, aggregate floor area, building height, or number of stories of a structure. [NFPA 101]

2-1.2 Authority Having Jurisdiction (AHJ).

The term "*AHJ*" as used in this UFC and the codes and standards referenced in this UFC means the Fire Protection Engineer assigned to the Military Service or Defense Component office of responsibility listed below. The exercise of *AHJ* is contingent upon maintaining the qualifications required of the Fire Protection Engineer. For the Defense Components not listed, and where a listed Defense Component is unable to maintain the qualifications of the Fire Protection Engineer, *AHJ* falls to the Military Service with jurisdiction of the *Installation* on which the facility is located.

AHJ offices are as follows:

- a. U.S. Army - HQ USACE/CECW-CE.
- b. U.S. Navy - NAVFACENGCOM HQ Code CHE.
- c. U.S. Marine Corps - HQMC Code LF.
- d. U.S. Air Force - AFCEC/CO.
- e. Defense Logistics Agency (DLA), DS-IE.
- f. National Geospatial-Intelligence Agency (NGA) - Security and Installations.
- g. National Reconnaissance Office (NRO) - MS&O/ESO.
- h. Washington Headquarters Services (WHS) - Office of the Pentagon Fire Marshal.
- i. National Security Agency/Central Security Service - Office of Occupational Health, Environmental and Safety Services (NSA/CSS OHESS).

2-1.3 /1/Bin Storage.

Bin storage consists of five-sided, open from top or side storage containers, stacked in rack structures. They are commonly used in automatic storage and retrieval systems.

Note: Bin storage requires unique considerations for fire protection. Bin storage configurations do not limit oxygen supply. Horizontal flame spread can be rapid. The narrower the aisles and the higher the storage, the less ceiling sprinkler water penetration is delivered to control the fire.

2-1.4 Distribution Main.

Any pipe in a water distribution system other than a *Service Main* or *Service Lateral*. A distribution main carries water from the original source (i.e. tank or underground water source) to the *Service Main*. A distribution main can be connected to the source, *Service Main* or another distribution main. A distribution main cannot connect to a *Service Lateral*.

2-1.5 DoD Component.

The specific DoD branch or subunit of a branch or service. For the purpose of this UFC, this includes, but is not limited to, Army, Navy, Marines, Air Force, NRO, WHS, NGA and NSA.

2-1.6 Dwelling Unit.

One or more rooms arranged for complete, independent housekeeping purposes, with space for eating, living, and sleeping; facilities for cooking; and provisions for sanitation. [NFPA 101]

2-1.7 Electronic Equipment Area.

Areas of a *Facility* that include, but are not limited to data centers, communication centers, and command and control systems. Electronic equipment areas are also areas containing telecommunication equipment that serves more than one *Facility*, a portion of an *Installation* or the entire *Installation*. This section does not apply to the room in a *Facility* that contains the incoming telecommunications service for that specific *Facility* or *Incidental Electronic Equipment* rooms.

2-1.8 Exemption.

The authority to deviate from a UFC requirement indefinitely. See MIL-STD-3007.

2-1.9 Facility.

This includes all types of buildings and their contents, structures, mobile and stationary equipment, civil works or military buildings, hydroelectric plants, waterfront structures,

outside storage, and shore protection for ships and aircraft. A facility can be either of temporary or permanent construction.

2-1.10 Fire Alarm Reporting System.

Fire alarm reporting systems are the *Installation*-wide reporting systems that connect the *Facility* fire alarm control panel(s) to a constantly attended location staffed with qualified operators for the receipt and processing of emergency communications. Consider compatibility of extensions of fire reporting systems with existing equipment.

2-1.11 Fire Area.

The aggregate floor area enclosed and bounded by fire walls, fire barriers, exterior walls or horizontal assemblies of a *Facility*. Areas of the *Facility* not provided with surrounding walls must be included in the *Fire Area* if such areas are included within the horizontal projection of the roof or floor above. [IBC]

2-1.12 Fire Flow.

The flow rate of a water supply, measured at 20 psi (138 kPa) residual pressure that is available for firefighting. [NFPA 1]

2-1.13 Fire Water Demand.

The fire water demand is the water flow required for the fire suppression system plus $\sqrt{2}$ interior/exterior hose stream demands./2/

2-1.14 Fire Protection Engineer.

2-1.14.1 Designated (or Service) Fire Protection Engineer (DFPE).

The DoD fire protection engineer that oversees that Area of Responsibility for that project. This is sometimes referred to as the “cognizant” fire protection engineer.

Note 1: For USACE, this is usually the District or Center FPE.

Note 2: For NAVFAC, this is usually the Facilities Engineering Command (FEC) FPE.

2-1.14.2 Qualified Fire Protection Engineer (QFPE).

$\sqrt{2}$ An individual who is a registered professional engineer (P.E.) who has passed the fire protection engineering written examination administered by the National Council of Examiners for Engineering and Surveying (NCEES) and has relevant fire protection engineering experience./2/

2-1.15 Incidental Electronic Equipment.

Word processing stations, printers, and systems; desk top computers; office automation systems; individual data output stations (i.e. printers, etc.); individual computer work stations; telephones; communication equipment; video conference centers; administrative telephone rooms; reproduction equipment; and similar equipment. Incidental Electronic Equipment includes building only or building-wide communication/telephone/LAN equipment typically found in communication, data or telephone rooms that do not serve an essential mission or purpose for National Defense. This includes the room in a *Facility* that contains the incoming telecommunications service for that specific *Facility*.

2-1.16 \5\5/Installation.

As used in this document, the Installation is the DoD base, post, camp, fort, station, airfield or other similar complex that shelters military equipment or personnel or facilitates training and operation. An Installation includes one or more DoD *Facilities*.

2-1.17 Life Safety System.

Those systems that enhance or facilitate evacuation, smoke control, compartmentalization or isolation. [NFPA Glossary of Terms]

2-1.18 Major Project.

A project that includes any one of the following:

- a. \5\ Adding /5/ to an existing *Facility*.
- b. \5\ Work to a facility that consists /5/ of 50 percent or more of the total floor area of an existing *Facility*.
- c. Design or construction of a new *Facility*.
- d. New installation or \5\ work to /5/ an area of construction greater than 5,000 ft² of floor area that involves existing or new fire barriers or fire-rated construction; *Life Safety Systems*; fire alarm or detection systems; fire suppression systems.

Note: Modification of 20 or more existing sprinklers is considered a Major Project.

- e. New installation or \5\ work to an /5/ existing HVAC systems that removes or installs the duct work passing through fire-rated or smoke partitions/barriers or interconnected plenum areas serving an area greater than 5,000 ft² of floor area.

2-1.19 Mass Notification System.

Refer to UFC 4-021-01.

2-1.20 \2\2/Medical Facilities.

Also referenced as Medical Treatment Facilities (MTFs), includes medical and dental treatment facilities, medical training facilities, medical research facilities, and veterinary facilities in the Military Health System (MHS)

2-1.21 Missile Alert Facilities (MAF).

The aboveground *Facilities* that support underground ballistic missile launch control centers.

2-1.22 Missile Assemblies.

Missile assemblies are considered to be large rocket type, cruise missiles without their ordnance, intercontinental ballistic missiles, or Poseidon missiles.

2-1.23 \5\5/Multi-Family Housing.

More than two *Dwelling Units* under one roof intended for occupancy by spouses or dependents of DoD personnel. \2\Multi-Family Housing does not include multiple single-family dwellings, i.e., townhouses./2/

2-1.24 Noncombustible Material.

A material that, in the form in which it is used and under the conditions anticipated will not ignite, burn, support combustion, or release flammable vapors, when subjected to fire or heat. Materials that are reported as passing ASTM E136 must be considered noncombustible materials. [NFPA 102]

2-1.25 Ordnance Facility.

A *Facility* or area used for the manufacturing, storage, maintenance or demilitarization of ordnance including, but not limited to, munitions, weapons, missile assemblies.

2-1.26 \5\5/Reliable Power Source.

2-1.26.1 For a *Facility* located on an *Installation*, reliability is determined at the power source serving the *Installation*. For a *Facility* not located on an *Installation*, reliability is determined at the power source to the *Facility*.

Note: For example, if the building in question is located on a Navy Base, Army Post or similar, reliability is determined by when power is lost to the entire Base, Post or similar, not the actual building. If the building is located away from a Base, Post or similar, reliability is determined by when power is lost to the building itself.

2-1.26.2 Unless otherwise noted, a reliable power source is a power source having forced down time, excluding scheduled repairs, that does not exceed 8 consecutive hours

for any one incident within the last 3 years, or more than 24 hours cumulatively over the last 3 years.

2-1.27 \5\ /5/Review Stamp.

A stamp certifying that the *QFPE* has reviewed the document and finds that it meets all contractual requirements. A Review Stamp is not a professional engineer stamp or seal.

2-1.28 Sensitive Compartmented Information Facility (SCIF).

Accredited areas, room(s), or building(s) where Sensitive Compartmented Information (SCI), is stored, used, processed or discussed. SCIF are only required for SCI and not necessarily required for Secret or Top Secret information. [UFC 4-010-05]

2-1.29 Service Lateral.

A pipe that connects to the *Service Main* and terminates at a fire hydrant or a *Facility*. A service lateral to a *Facility* is permitted to have no more than two fire hydrants. A service lateral does not connect from one *Service Main* to a second *Service Main*.
\4\4/.

2-1.30 Service Main.

A pipe that transports water from the *Distribution Main* to the *Service Lateral*. A service main can be connected to a *Distribution Main*, *Service Lateral* or another service main. A main with three or more fire hydrants connected to it is a service main. A main from a fire pump to more than one building is a service main.

2-1.31 Stakeholders.

A group of identified individuals or representatives, typically having authoritative control or input, having a share or interest in the successful completion of a project. A project's identified stakeholders must include the building's design and construction team members, security, the *AHJ*, accreditation agencies, tenants, supported commands and emergency responders.

2-1.32 Telecommunications Equipment Areas.

See "Electronic Equipment Areas".

2-1.33 Tension Membrane Structure.

A membrane structure incorporating a membrane and a structural support system such as arches, columns, and cables, or beams wherein the stresses developed in the tension membrane interact with those in the structural support so that the entire assembly acts together to resist the applied loads. [NFPA 102]

2-1.34 Very Early Warning Smoke Detection.

Detection that is listed as being capable of providing the level of protection as defined in NFPA 76 for Very Early Warning Fire Detection. Aspirating smoke detection installed in Europe must comply with Class A requirements as specified in EN54 (Fire Detection and Fire Alarm Systems), Part 20 (Aspirating Smoke Detection) (EN54-20).

The maximum area of coverage per detector, or sampling point, is 200 ft² (18.5 m²) for one level of detectors. A minimum of one alert and one alarm level are provided.

This Page Intentionally Left Blank

CHAPTER 3 USE AND OCCUPANCY CLASSIFICATION

3-1 GENERAL

This UFC utilizes criteria from both IBC and NFPA 101. Care must be exercised when using this UFC to ensure proper use of IBC and NFPA 101.

3-2 INTERNATIONAL BUILDING CODE (IBC).

3-2.1 General.

3-2.1.1 The IBC must be used where dictated by UFC 1-200-01 except where noted in this UFC.

3-2.1.2 The IBC must be utilized to determine the occupancy classification as it relates to allowable construction type, building height, building area, building separation distance, occupancy separation and associated requirements.

3-2.1.3 Medical funded projects, including but not limited to, healthcare, ambulatory healthcare and all facilities required to comply with The Joint Commission standards must comply with NFPA 101 in its entirety.

3-3 NFPA 101.

3-3.1 General.

3-3.1.1 NFPA 101 must be utilized to determine the occupancy classification as it relates to fire/smoke resistance rating of interior non-load bearing partitions (other than occupancy separation), means of egress, interior finish, features of fire protection (including vertical openings) and associated requirements.

3-3.1.2 Where specific criteria is provided in NFPA 101 related to occupancy location within a building (i.e. story), conform to the requirements of NFPA 101 based on the equivalent construction type.

Note: Where IBC permits a particular occupancy classification on the third floor of a building of Type IIB construction and NFPA 101 only permits that occupancy classification on the second floor for Type II (000), the occupancy is only permitted on the second floor.

3-3.1.3 Appendix D provides a cross reference between the construction types referenced in NFPA 220 and the IBC.

3-4 HAZARDOUS MATERIALS.

For the purpose of occupancy classification, the maximum allowable quantities (exempt amounts) noted in NFPA 400 must be used. Where the maximum allowable quantities are exceeded in NFPA 400, the H occupancy classification (H-1, H-2, etc.) must be

defined in accordance with IBC for High-Hazard Group H occupancies, except as modified by this UFC. IBC Chapter 4 must be utilized to determine the IBC occupancy type. IBC Chapter 4 is not to be utilized for hazardous materials requirements.

Table 3-1 Hazardous Materials Classification

HAZARDS	NFPA 400 & NFPA 1 CLASSIFICATION	NFPA 400 & NFPA1 PROTECTION LEVEL	IBC GROUP H CLASSIFICATION
Detonation Hazard	High Hazard Level 1	Protection Level 1	H-1
Deflagration Hazard	High Hazard Level 2	Protection Level 2	H-2
Physical Hazard	High Hazard Level 3	Protection Level 3	H-2 or H-3
Health Hazard	High Hazard Level 4	Protection Level 4	H-4
HPM Facility	Not Applicable	Not Applicable	H-5

CHAPTER 4 SPECIAL DETAILED REQUIREMENTS BASED ON USE

4-1 GENERAL.

This Chapter provides specific criteria for special or unique occupancies and hazards and supersedes IBC Chapter 4 in its entirety. For special or unique occupancies and hazards not addressed in this Chapter, comply with the requirements of NFPA 101. This Chapter either supersedes or is in addition to requirements in other Chapters of this UFC.

4-2 ADDITIVE MANUFACTURING (3D PRINTING TECHNOLOGY AND COLD SPRAY MATERIAL-DEPOSITION PROCESS TECHNOLOGY).

4-2.1 General.

Additive manufacturing includes manufacturing process using polymer, glass, or ceramic powders including any material with minimum ignition energy greater than 10mJ (ASTM E2019 or EN 13821).

4-2.2 Additive manufacturing processing equipment.

Additive manufacturing process equipment using combustible powders with a maximum ignition energy of 10mJ or less, including metal powders such as stainless steel (any alloy mix), aluminum (any alloy mix), and titanium (any alloy mix) must comply with the following:

- Must be located in a separate building, or:
- Be located in a separate room with an exterior wall and separated by construction of not less than 2-hour fire rating, and,
- Have explosion venting through the exterior wall. Explosion venting may comply with either FM Global or NFPA 68; or for European countries, VDI 3673 (Verein Deutscher Ingenieure).

Note: See NFPA 652, NFPA 68, and FM Global Loss Prevention Data Sheet 7-76 for additional information./5/

4-3 AIRCRAFT ACOUSTICAL ENCLOSURES.

4-3.1 Complete Enclosures (Hush House).

For Air Force, Aircraft Acoustical Enclosures are not classified facilities (real property); they are classified equipment and as such are managed by the Air Force Sustainment Center, Air Force Logistic Complex, Propulsion Support Equipment, Hush Houses/ Noise Suppressors (AFLCMC/WNZEC) Robins AFB, GA. The criterion of the UFCs does not apply to this equipment. These systems are centrally managed and are not constructed nor maintained as facilities under this UFC. The fire protection system

controls in such enclosures are provided with connection to the installation fire alarm communication network by the installation.

4-3.1.1 Conform to the requirements listed in the paragraph entitled "Aircraft Facilities". Provide separate manual controls for actuation of each foam system.

4-3.2 Out of Airframe Acoustical Enclosures (Test Cells).

Fire protection system for Test Cells must consist of the following:

- a. Overhead water deluge system having a density of 0.35 gpm/ft² (14.3 L/min/m²) over the entire floor area.
- b. Water spray system for the engine having a density of 0.50 gpm/ft² (20.4 L/min/m²) of engine surface area.
- c. Water spray system for the floor area beneath the engine having a density of 0.50 gpm/ft² (20.4 L/min/m²) over the entire shadow area.

Note: The overhead deluge system need not extend into the area where the water spray systems for the engine and floor are present.

4-4 AIRCRAFT FACILITIES.

4-4.1 Aircraft Hangars.

For fixed wing and rotary wing aircraft fuel cell maintenance facilities, alert, storage, depot-level and general-purpose maintenance hangars comply with UFC 4-211-01. For corrosion control hangars, comply with UFC 4-211-02.

4-4.2 Tensioned-Membrane Hangars.

4-4.2.1 Construction type must conform to NFPA 409. Tension fabric hangars must utilize rigid-steel-frame structures.

4-4.2.2 The minimum separation between tensioned-membrane hangars and all other structures must be 100 feet (30.5 m), with a clear zone of 50 feet (15.3 m) immediately adjacent to the tension fabric structure. The clear zone cannot be used for storage and must be clear of vegetation (maintained lawn is permitted). The clear zone may be used as a street or driveway, but not for vehicle parking. The clear zone must be clearly striped to indicate no storage or parking.

Note: For Navy, see OPNAVINST 11010.33 for regulations and restrictions on the use of relocatable facilities.

4-4.3 Aircraft Weather Covering.

Weather coverings used for aircraft on the flight line (see Figure 4-1), regardless of material, do not require a fire detection or suppression system. Any permanent

electrical devices or equipment (receptacles, lighting, or other similar devices) installed on the aircraft weather covering (sunshade) must comply with the requirements for aircraft hangars in NFPA 70 as well as the criteria for fuel servicing safety zone found in the individual *DoD Component* criteria (i.e. AF T.O. 00-25-172, NAVAIR 00-80R-14, NAVAIR 00-80T-109 or AR 420-90).

Figure 4-1 Examples of Weather Covering

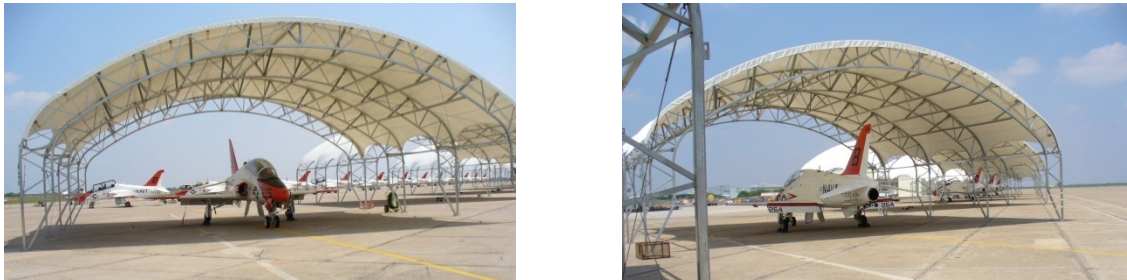

4-4.4 *Facilities Housing Unmanned Aerial Vehicles (UAV) or Remotely Piloted Aircraft (RPA).*

4-4.4.1 For this UFC, an Unmanned Aerial Vehicle (UAV) or Remotely Piloted Aircraft (RPA) consists of just the vehicle; and, an Unmanned Aerial System (UAS) consists of the vehicle, launcher, and any other associated equipment for that system.

4-4.4.2 *Facilities* designed to support UAS, UAV, or RPA that have both of the following must be protected in accordance with the section for Aircraft Hangars in this UFC:

- a. Combined fuel capacity of all UAS, UAV, or RPA equal to or greater than 240 gallons (908.4 L) and
- b. Access to a runway that supports manned aircraft.

4-4.4.3 *Facilities* designed to support UAS, UAV, or RPA that have both of the following must be protected in accordance with the section for Aircraft Hangars in this UFC:

- a. Has a door opening greater than or equal to 20 feet (6.1m) in height and
- b. Access to a runway that supports manned aircraft.

4-4.4.4 *Facilities* designed to support UAS, UAV, or RPA that have both of the following must be provided with sprinklers designed in accordance with NFPA 30, *Storage of Liquids in Containers – Storage Occupancies*:

- a. Combined fuel capacity of all UAS, UAV, or RPA is equal to or greater than 240 gallons (908.4 L) and

- b. No access to a runway that supports manned aircraft.

4-4.4.5 *Facilities* designed to support UAS, UAV, or RPA that have both of the following must be provided with sprinklers designed in accordance with NFPA 30, *Storage of Liquids in Containers – Storage Occupancies*:

- a. Has a door opening less than 20 feet (6.1m) in height and
- b. Access to a runway that supports manned aircraft.

4-4.4.6 *Facilities* designed to support UAS, UAV, or RPA that have both of the following must be protected with automatic sprinklers:

- a. Combined fuel capacity of all UAS, UAV, or RPA is more than 120 gallons (454.2 L) and less than or equal to 240 gallons (908.4 L) and
- b. No access to a runway that supports manned aircraft.

4-4.4.7 *Facilities* designed to support UAS, UAV, or RPA that have all of the following do not require automatic sprinklers:

- a. Combined fuel capacity of all UAS, UAV, or RPA is less than 120 gallons (454.2 L) per control area (as defined by NFPA 30),
- b. No access to a runway that supports manned aircraft,
- c. Sprinkler protection is not required by the "Application Requirements" paragraph in the section for Automatic Sprinkler Systems in this UFC,
- d. Supports small, human packable, portable UAV or RPA, and
- e. The facility is separated from other structures by a minimum of 100 feet (30.5 m).

4-4.4.8 For Army, in addition to the aforementioned paragraphs, *Facilities* designed to support UAS or UAV must be protected as follows. If there is a conflict between the aforementioned paragraph and this paragraph, follow the more stringent paragraph.

- a. *Facilities* housing Group 4 UAS or UAV must be protected in accordance with the section for Aircraft Hangars in this UFC. Group 4 UAV weigh more than 1,320 LBS.
- b. *Facilities* housing Group 3 UAS or UAV, where the fire area of the aircraft servicing or storage area exceeds 7,500 ft², must be protected in accordance with the section for Aircraft Hangars in this UFC. Group 3 UAV weigh more than 56 LBS but less than 1,320 LBS.
- c. *Facilities* housing Group 3 UAS and UAV, where the fire area of the aircraft servicing or storage area does not exceed 7,500 ft², but is required by another section of the UFC to have sprinklers, must have the aircraft servicing or storage area protected in accordance with NFPA 30,

Storage of Liquids in Containers – Storage Occupancies. All operations outside the UAV or UAS housing area must be isolated from the UAV or UAS housing area by 1-hour fire barrier walls. Floor elevations must be arranged to prevent a spill within the UAV or UAS housing area from flowing into adjacent areas. Adjacent areas are not permitted to have their required egress through the UAV or UAS housing area, except for normally unoccupied rooms less than 100 ft².

- d. *Facilities* housing Group 3 UAS and UAV, where the fire area of the aircraft servicing or storage area does not exceed 7,500 ft², and is not required by another section of the UFC to have sprinklers, is not required to have a suppression system. All operations outside the UAV or UAS housing area must be isolated from the UAV or UAS housing area by 1-hour fire barrier walls. Floor elevations must be arranged to prevent a spill within the UAV or UAS housing area from flowing into adjacent areas. Adjacent areas are not permitted to have their required egress through the UAV or UAS housing area, except for normally unoccupied rooms less than 100 ft²./2/

Note: The reference to NFPA 30 in this section pertains to sprinkler requirements only and is not intended to follow all of the requirements in NFPA 30.

4-5 ANECHOIC CHAMBERS.

Fire protection goals must comply with the section titled "Protection of Chamber and its Contents" as specified in FM Global Data Sheet 1-53. \4/4/.

4-6 CHILD DEVELOPMENT PROGRAMS.

4-6.1 Child Development Centers (CDC).

Comply with UFC 4-740-14. For Navy/Marines, comply with FC 4-740-14N.

4-6.2 Continuous Child Care Facilities (24/7).

Comply with UFC 4-740-15.

4-6.3 Other Child Development Programs.

Other child development programs include part-day, preschool, kindergarten, before and after school programs, school-age *Facilities*, etc. Comply with the provisions of educational occupancies in NFPA 101.

4-6.4 Youth Centers.

Youth centers must comply with UFC 4-740-06.

4-7 COAL.

4-7.1 General.

Coal storage and handling must comply with NFPA 850 and FM Loss Prevention Data Sheet 8-10.

4-7.2 Pulverizing Equipment.

Use components designed and constructed in accordance with requirements of NFPA 850.

4-8 COMMISSARIES AND EXCHANGES.

4-8.1 Mixed Occupancy.

Commissaries and Exchanges that are part of another facility (i.e., mixed occupancy) and the Commissary or Exchange area is greater than 8,000 ft² (743.2 m²) gross floor area, the entire facility must meet the requirements of the sprinkler "Application Requirements" section of this UFC.

4-8.2 Standalone.

Commissaries and Exchanges that are a separate facility (i.e. standalone) and greater than 8,000 ft² (743.2 m²) gross floor area must be provided with automatic sprinkler protection regardless of construction type.

4-9 COMPACT MOBILE SHELVING.

4-9.1 Reserved.

4-10 DEPARTMENT OF DEFENSE EDUCATION ACTIVITY (DODEA).

DoDEA *Facilities* must comply with the requirements in this UFC.

4-11 DETENTION AND CORRECTIONAL FACILITIES.

4-11.1 Requirements.

Comply with NFPA 101 and the following:

4-11.1.1 Individual *Fire Areas* must not exceed 50,000 ft² (4,647 m²).

4-11.1.2 Construction type must be Type I-A, as defined in the IBC.

4-11.1.3 Provide a minimum separation from other structures and public ways of 20 feet (6.1 m).

4-11.1.4 Provide complete automatic sprinkler protection. Design must utilize institutional (breakaway) type sprinklers in areas accessible to detainees or inmates. Sprinkler piping in detainee or inmate areas must be concealed.

4-11.1.5 Provide an automatic smoke control system in cell areas. In addition, provide manual system activation controls at a continuously manned position outside of the cell area. Design the smoke control system in accordance with NFPA 92.

4-11.1.6 Provide for constant visual supervision of cell areas. Central supervisory control area must be separated from cell areas by not less than one-hour fire-rated construction.

4-11.1.7 Fire alarm notification in cell areas must be at a constantly attended location, with detainees or inmates notified by the staff of fire events. Positive alarm sequence is permitted to be provided in accordance with NFPA 72.

4-11.1.8 Locking Devices.

Provide mechanical or electrical gang release, and individual release devices whenever 10 or more locks must be operated to release prisoners confined in cells. Require gang release devices to open doors necessary to evacuate prisoners to an area of refuge. Require heavy, identically keyed, prison-type locks for exit and corridor doors not requiring gang release devices that must be opened for evacuation in the event of fire.

Dormitory-style confinement facilities are not required to meet the above criteria.

4-11.1.9 Interior Finish.

Interior finish including padded cells must be Class A flame spread (i.e., 25 or less) and must have a smoke development rating not exceeding 50 when tested in accordance with ASTM E84.

4-11.1.10 Navy *Facilities* must also comply with the ACA's Planning and Design Guide for Secure Adult and Juvenile Facilities.

4-12 ELECTRONIC EQUIPMENT AREAS.

This section applies to *Electronic Equipment Areas* and telecommunications areas as defined in this UFC.

4-12.1 General.

4-12.1.1 Construct and protect *Electronic Equipment Areas* in accordance with NFPA 75, except as modified by this UFC.

4-12.1.2 For Air Force *Facilities*, comply with ETL 01-18 for fire protection criteria, in lieu of this section.

4-12.2 Telecommunication Equipment Areas.

This section applies to areas containing telecommunication equipment that serves more than one *Facility*, a portion of an *Installation* or the entire *Installation*. This section does not apply to the room in a *Facility* that contains the incoming telecommunications service for that specific *Facility*.

4-12.2.1 Telecommunication areas must comply with NFPA 76, in lieu of NFPA 75.

Buildings housing telecommunication areas must be of noncombustible construction.

4-12.2.2 Co-located *Facility*.

For *Facilities* that house telecommunication areas that have occupancies and uses other than telecommunication, the entire *Facility* must be provided with sprinkler protection, including the telecommunication area.

4-12.2.3 Stand-alone *Facilities*.

4-12.2.3.1 For stand-alone *Facilities* greater than 2,500 ft² (232 m²), provide a fire extinguishing system in accordance with *either* the paragraph entitled "Clean Agent Fire Extinguishing Systems" *or* "Sprinkler Systems" below.

4-12.2.3.2 For stand-alone *Facilities* greater than 7,500 ft² (696 m²), provide a sprinkler system in accordance with the paragraph entitled "Sprinkler Systems" below. A clean agent fire extinguishing system can be provided in addition to, but not in lieu of, the sprinkler system.

4-12.2.3.3 Single-story *Facilities* may be of Type II-B construction.

4-12.3 Smoke Detection.

4-12.3.1 *Electronic Equipment Areas* must be protected by Very Early Warning Smoke Detection systems.

4-12.3.2 Smoke detection must provide not less than two distinct alarm conditions (levels) indicating increasing smoke/combustion levels.

4-12.3.3 Smoke detection must notify equipment operators of all distinct threshold conditions/levels. Where operators are not in constant attendance, alarm signals must notify the constantly attended alarm receiving location.

4-12.4 Sprinkler Systems.

4-12.4.1 *Electronic Equipment Areas* must be located in *Facilities* protected by wet pipe automatic sprinklers, except those telecommunication areas identified above.

4-12.4.2 Provide complete wet pipe sprinkler protection throughout the *Electronic Equipment Area*.

4-12.4.3 The *Electronic Equipment Area* must be able to be isolated from other areas by a zone control valve assembly. The control valve assembly must include a control valve, waterflow switch and inspector's test connection.

Note: Consult with the DFPE to determine the extent, or boundary, of the *Electronic Equipment Area*.

4-12.4.4 For areas with finished ceilings, use concealed pendent or concealed sidewall sprinklers. For areas without finished ceilings, use upright sprinklers with listed sprinkler guards or concealed sidewall sprinklers.

4-12.4.5 Fire sprinklers must not be provided below raised floors.

4-12.5 Clean Agent Fire Extinguishing System.

Note: Consideration may be given to the use of a supplementary, $\sqrt{2}$ /clean agent fire extinguishing system inside the electronic equipment units or a total flooding system for the room and raised floor.

4-12.5.1 Clean agent fire extinguishing systems must not be utilized as a substitute for automatic sprinklers.

4-12.5.2 Where the requirements of the paragraph entitled "Power and Communication Cabling" are not met, the room and the effected space above the ceiling and below the floor in the room must be protected by a $\sqrt{2}$ /clean agent fire extinguishing system. Where only the below floor area is affected, it is acceptable to provide a $\sqrt{2}$ /clean agent fire extinguishing system below the floor only.

4-12.5.3 *Very Early Warning Smoke Detection* must be used to activate a clean agent fire extinguishing system.

4-12.6 Electronic Equipment Power Disconnect.

4-12.6.1 A means to disconnect power to critical electronic equipment must be provided as required by NFPA 70.

4-12.6.2 The power disconnect method may be by manual means for *Electronic Equipment Areas* with one of the following:

- a. Areas that are constantly occupied (24 hours per day, 7 days a week) by personnel familiar with the electronic equipment, or
- b. Areas located within a *Facility* that are constantly staffed by a trained response force having ready access to the *Installation* and trained in emergency shutdown procedures.

4-12.6.3 Where multiple rooms are located in one area that utilize power disconnect simultaneous to water discharge, coordinate with the customer on the shutdown requirements. If all adjacent areas may be considered as one, with power to all discontinued simultaneously, the entire area may be protected by one sprinkler system. However, if the customer requires each physically separated area to operate independently of the other, provide separate shutdown capabilities for the separated areas.

4-12.6.4 Electrical equipment must be protected by disconnecting the power upon activation of the fire sprinkler system in the electronic spaces, unless power disconnect is permitted by manual means indicated above.

4-12.6.4.1 The disconnect must be installed downstream of any UPS or similar equipment such that when the disconnect switch is activated, the UPS cannot supply power to the equipment.

4-12.6.4.2 Electrical power disconnect is not required when approved by the *DFPE*.

4-12.7 Power and Communication Cabling.

Power and communication (data) cabling installed in spaces above ceilings or below raised floors must be plenum rated or installed in non-combustible conduit in accordance with NFPA 70.

4-13 ELEVATORS.

4-13.1 General.

This section provides criteria for electric traction, machine room-less equipment and hydraulic elevators. Elevators must comply with the requirements of ASME A17.1 except as modified by this section.

4-13.2 $\sqrt{2}$ /Fire-Resistant Construction.

4-13.2.1 The machine room must have the same fire resistance rating of the elevator shaft it serves.

4-13.2.1.1 This requirement applies to the room containing the elevator controller for machine room-less elevator systems.

4-13.3 Detection.

4-13.3.1 Provide smoke detectors at all elevator lobbies not open or exposed to the exterior (i.e. open parking structures and similar elevator lobbies) and all elevator machine rooms, including where machine room-less controllers are located.

4-13.3.2 Provide smoke detectors at the top of elevator hoistway only when automatic sprinklers are provided in the hoistway.

4-13.3.3 Provide listed control relays within 3 feet (915 mm) of the elevator controller to provide a supervised interface between the fire alarm system and the elevator controller as required by NFPA 72. The wiring between the control relays and the fire alarm control unit must be monitored for integrity as required by NFPA 72.

4-13.3.4 Activation of any elevator machine room, hoistway, or lobby smoke detector must activate the *Facility* fire alarm system and send the affected elevators to the designated floor.

4-13.4 Sprinkler Protection.

4-13.4.1 Where sprinklers are provided in the *Facility*, provide sprinklers for the elevator as noted below.

4-13.4.2 Elevator Machine Room.

4-13.4.2.1 Provide sprinkler(s) with listed sprinkler guard(s) in the machine room(s).

4-13.4.2.2 Provide a supervised shut-off valve, check valve, waterflow switch, and test valve in the sprinkler line supplying the machine room(s). These items must be located outside of and adjacent to the machine room(s).

4-13.4.2.3 Actuation of the waterflow switch must remove power to the elevator(s) served by that machine room, by direct connection from the waterflow switch (i.e. DPDT switch) to the shunt trip breaker.

4-13.4.2.4 The waterflow switch must have no time delay capability.

4-13.4.2.5 Provide an inspector's test connection for each waterflow switch associated with the elevator machine room. Locate the test connection outside the machine room. Route test connection piping to a floor drain location that can accept full flow or where water may be discharged without property damage. Discharge to a floor drain may be permitted only if the drain is sized to accommodate full flow (minimum of 40 gpm). Discharge to service sinks or similar plumbing fixtures is not permitted.

4-13.4.3 Top of Hoistway.

4-13.4.3.1 Provide sprinklers at the top of the hoistway when elevator machinery is located within the shaft.

4-13.4.3.2 When sprinklers are provided at the top of the hoistway, a supervised shut-off valve, check valve, waterflow switch, and test valve must be provided in the sprinkler line supplying the top of hoistway.

4-13.4.3.3 Actuation of the waterflow switch must remove power to the elevator(s) served by that hoistway, by direct connection from the waterflow switch (i.e. DPDT switch) to the shunt trip breaker.

4-13.4.3.4 The waterflow switch must have no time delay capability.

4-13.4.3.5 Provide an inspector's test connection for each waterflow switch. Locate the test connection outside the hoistway. Route test connection piping to a floor drain location that can accept full flow or where water may be discharged without property damage. Discharge to a floor drain may be permitted only if the drain is sized to accommodate full flow (minimum of 40 gpm). Discharge to service sinks or similar plumbing fixtures is not permitted.

4-13.4.3.6 The top of the hoistway and machine room sprinklers may be served by the same control valve assembly and flow switch.

4-13.4.4 Hoistway Pit.

4-13.4.4.1 Provide sprinklers in elevator pits as required by NFPA 13.

4-13.4.4.2 Provide a supervised shut-off valve in the sprinkler line supplying the pit. Locate the valve outside of and adjacent to the pit. Actuation of the pit sprinkler must not disconnect power to the elevator.

4-13.5 Host Nation.

Comply with the requirements of this section and Host Nation requirements. If requirements in this section violates host Nation laws, follow the Host Nation laws. For Host Nation projects in Japan, see Appendix "Criteria for Facility Projects in Japan" in this UFC.

Table 4-1 Electric Traction Elevator

ROOM / AREA	PROVIDE SPRINKLER (Not Applicable for Buildings Without Sprinkler Protection)	PROVIDE SMOKE DETECTOR to INITIATE ELEVATOR FIREFIGHTERS SERVICE and BUILDING FIRE ALARM SYSTEM
PENTHOUSE MACHINE ROOM	YES	YES
ELEVATOR LOBBIES	YES	YES
PIT AREA	NO	NO
TOP of HOISTWAY	NO	NO

Table 4-2 Direct Plunger Hydraulic Elevator

ROOM / AREA	PROVIDE SPRINKLER (Not Applicable for Buildings Without Sprinkler Protection)	PROVIDE SMOKE DETECTOR to INITIATE ELEVATOR FIREFIGHTERS SERVICE and BUILDING FIRE ALARM SYSTEM
MACHINE ROOM	YES	YES
ELEVATOR LOBBIES	YES	YES
PIT AREA	YES	NO
TOP of HOISTWAY	NO	NO

Table 4-3 Holeless Hydraulic and Roped Hydraulic Elevator

ROOM / AREA	PROVIDE SPRINKLER (Not Applicable for Buildings Without Sprinkler Protection)	PROVIDE SMOKE DETECTOR to INITIATE ELEVATOR FIREFIGHTERS SERVICE and BUILDING FIRE ALARM SYSTEM
MACHINE ROOM	YES	YES
ELEVATOR LOBBIES	YES	YES
PIT AREA	YES	NO
TOP of HOISTWAY	NO	NO

Figure 4-2 Electric Traction Elevator

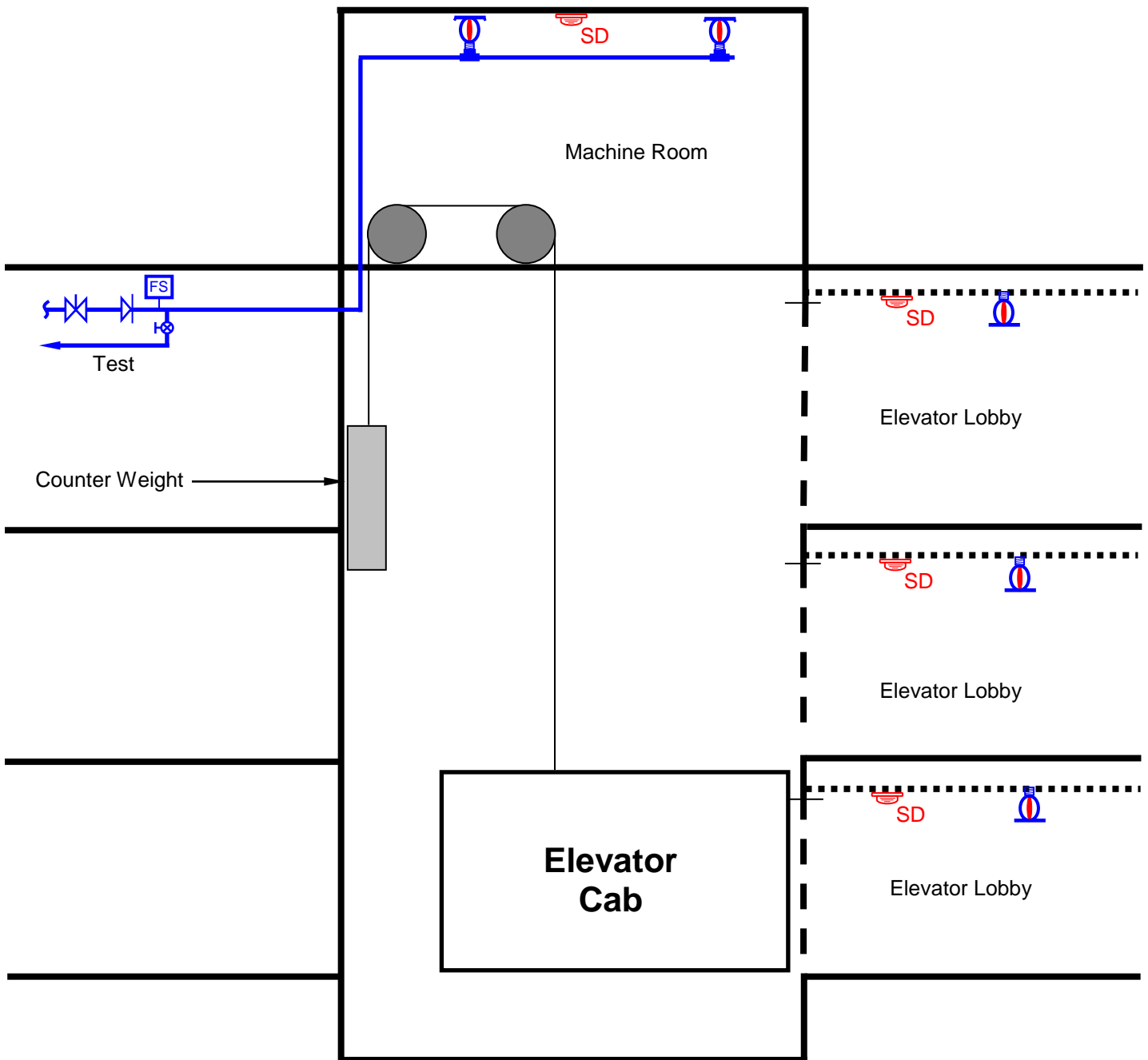

Figure 4-3 Direct Plunger Hydraulic Elevator

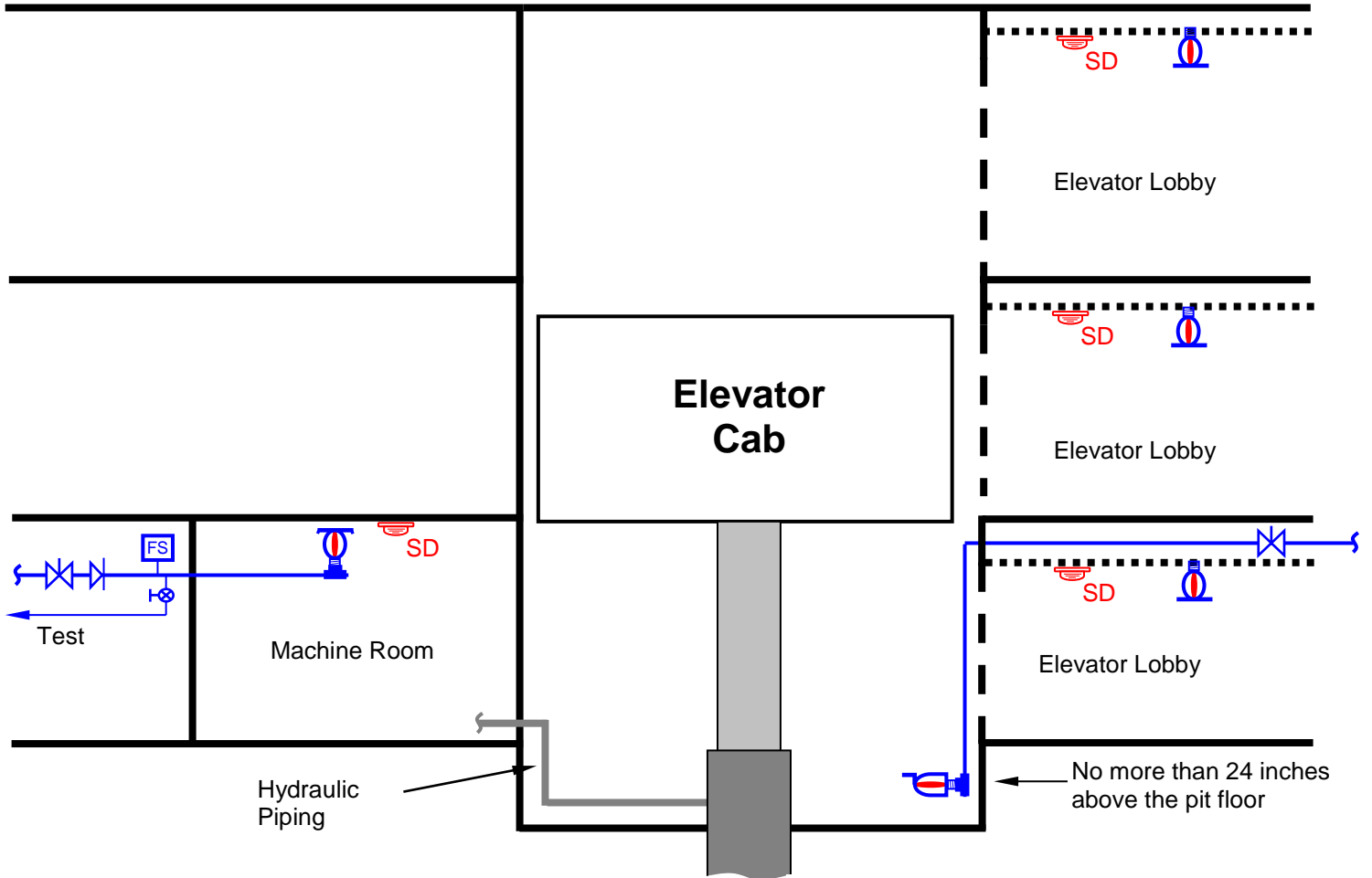
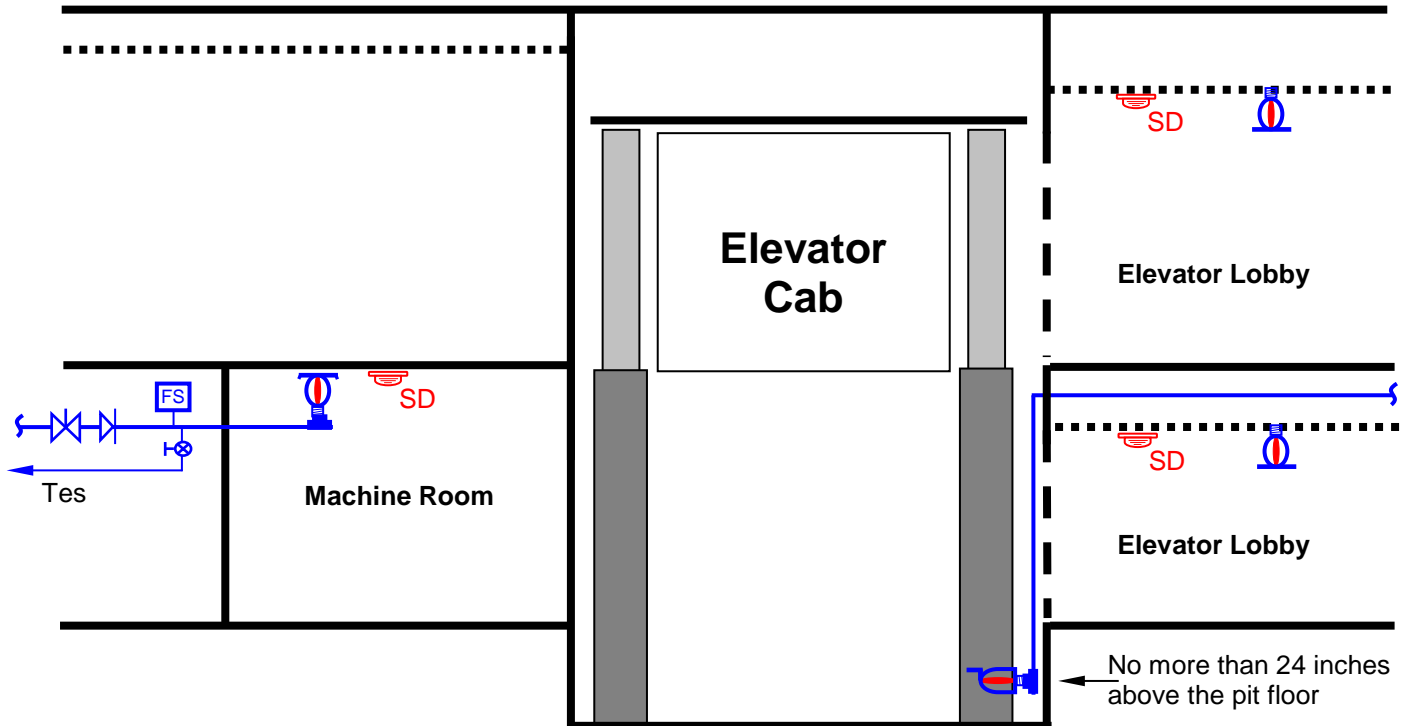

Figure 4-4 Holeless and Roped Hydraulic Elevator



4-14 EMERGENCY SERVICES COMMUNICATIONS CENTERS.

Facilities and equipment that are used for the receipt of alarm signals and telephone calls for assistance, and dispatching of fire, police, or emergency medical services personnel and equipment must comply with this UFC and NFPA 1221.

4-15 FAMILY HOUSING.

4-15.1 General.

This section includes \3\all family housing/3/.

4-15.2 Off-Installation Family Housing within the United States and its Territories.

Family housing located outside military *Installations* or bases must comply with provisions of this section and must comply with applicable local fire and building codes when the local fire department has the primary responding responsibility or a local building permit is required.

4-15.3 Family Housing Outside the United States and its Territories and Possessions.

Family housing outside the United States and its territories and possessions, constructed or leased-constructed, must comply with provisions of this section and the Host Nation fire protection requirements.

4-15.4 DoD-Leased Family Housing.

4-15.4.1 DoD personnel occupying DoD-leased housing deserve the same level of protection as those in DoD-owned housing. Implementation of these standards is therefore mandatory for all DoD-leased housing. \5\ /5/This requirement does not apply to housing leased by individuals.

4-15.4.2 New Buildings.

Buildings that are built to lease to DoD must comply with the standards for new construction.

4-15.4.3 Existing Buildings.

For new leases or renewals of leases of existing *Facilities*, the *Facilities* must comply with the requirements for new construction.

4-15.5 *Multi-Family Housing.*

Multi-Family Housing must comply with the IBC and NFPA 101 as required by other sections of this UFC.

4-15.6 One- and Two-Family Housing.

One- and two-family housing must comply with the IRC.\2\

4-15.7 /2/Cooking Areas.

A range top extinguishing system is not required within family housing for cooking areas provided with residential appliances.

4-16 **FOOD PREPARATION IN *FACILITIES*.**

4-16.1 Commercial Cooking Equipment.

4-16.1.1 Hood and duct systems for commercial cooking equipment that produces smoke or grease-laden vapors must comply with NFPA 96.

4-16.1.2 Range hood fire extinguishing systems must be wet chemical or water assisted wet chemical designed and installed in accordance with NFPA 96.

4-16.2 Residential Cooking Equipment.

4-16.2.1 Non-sprinklered Areas, Other than Housing.

4-16.2.1.1 Residential type range top cooking surfaces must be equipped with a UL 300A listed residential range top extinguishing system or the cooking surface must be equipped with burners and controls that have their temperature limited to a maximum temperature of 662 degrees F (350 degrees C).

4-16.2.1.2 The extinguishing system must be connected to the *Facility* fire alarm system, if provided, to sound a general *Facility* fire alarm and must automatically shut off all sources of fuel and electric power that produce heat to the equipment being protected by that unit.

4-16.2.2 Sprinklered Areas, Other than Housing.

4-16.2.2.1 Residential range top extinguishing systems are not required in sprinklered areas.

4-16.2.2.2 If a residential range top extinguishing system is provided, it must be connected to the *Facility* fire alarm system to sound a general *Facility* fire alarm and must automatically shut off all sources of fuel and electric power that produce heat to the equipment being protected by that unit.

4-16.2.3 Housing.

See "Personnel and Family Housing" section of this UFC for requirements related to cooking facilities in housing.

4-17 HAZARDOUS MATERIALS AND HAZARDOUS WASTE.

4-17.1 General.

Hazardous materials and hazardous waste (hazardous materials) include flammable and combustible liquids, flammable and combustible gases, flammable solids as well as other materials that are classified as hazardous materials.

4-17.1.1 Comply with the requirements of NFPA 400, except as noted in this section.

4-17.1.1.1 The requirements of this section apply to the storage or use of hazardous materials in excess of the maximum allowable quantities permitted by NFPA 400.

Note: As defined in NFPA 30, hazardous materials storage lockers and premanufactured storage buildings may be used to increase the maximum allowable quantities in accordance with NFPA 400.

4-17.1.1.2 Provide protection for facilities storing flammable and combustible liquids and other petroleum oil lubricant (POL) products in accordance with NFPA 30.

4-17.1.1.3 Class IIIB combustible liquids must be protected as required by NFPA 30 for Class IIIA combustible liquids in accordance with UFC 3-460-01 and NFPA 30.

4-17.1.2 A single building is often used for storage of both flammable and combustible liquids and hazardous materials. Requirements for the storage of hazardous waste are separate and distinct from the storage of hazardous materials.

4-17.1.3 Comply with the requirements of UFC 4-440-01.

4-17.1.4 All other hazardous materials storage and use must comply with NFPA 400.

4-17.2 Hazardous Materials Storage Areas.

4-17.2.1 Maximum Storage Height and Arrangement.

The maximum allowable height and arrangement for storage of hazardous materials must be in accordance with NFPA 400.

4-17.2.2 Fire Protection.

4-17.2.2.1 Complete automatic sprinkler protection must be provided throughout all hazardous material areas regardless of area or construction type.

4-17.2.2.2 Where the rack storage arrangement for hand picking operations provides multiple levels of storage less than 6 feet (1.8 m) above the walking surface and in-rack sprinklers are required for the storage arrangement, provide one extra row of in-rack sprinklers in the longitudinal flue space at the 3 feet (915 mm) level.

4-17.2.3 Hazardous material storage areas or rooms must be identified in accordance with NFPA 704.

4-17.2.4 In rooms storing water reactive materials, provide automatic sprinklers that can be isolated with an indicating valve. Locate the indicating valve outside the water reactive storage area.

4-17.3 Hazardous Waste Storage *Facilities*.

For hazardous waste storage *Facility* requirements, comply with NFPA 400 except as noted below.

For Air Force, Navy and Marines, comply with UFC 4-451-10N.

4-17.3.1 Fire Protection.

The following minimum criteria must be provided:

- a. Exterior walls must consist of 4-hour fire-resistive construction when the *Facility* is attached to a structure or it is located within 10 feet (3 m) of another building or property line.

- b. Exterior walls must consist of 2-hour fire-resistive construction when the *Facility* is located more than 10 feet (3 m) but less than or equal to 50 feet (15.3 m) from a building or property line.
- c. Exterior walls must be of noncombustible construction when the *Facility* is more than 50 feet (15.3 m) from another building or property line.
- d. Interior walls/ceilings must be 4-hour fire barriers if the *Facility* shares at least one wall with a *Facility* that houses other occupancies.
- e. Interior walls/ceilings must be a minimum 2-hour fire barrier when the area of the room is greater than 300 ft² (28 m²) and the *Facility* is not located within a structure that houses other occupancies.
- f. Interior walls/ceilings must be a minimum 1-hour fire barrier when the area of the room is 300 ft² (28 m²) or less and the *Facility* is not located within a structure that houses other occupancies.

4-17.3.2 Sprinkler Protection.

Install sprinkler systems suitable for a corrosive environment.

4-17.4 Spill Control and Containment.

Provide spill control and containment complying with NFPA 400 for hazardous materials and hazardous waste storage areas.

4-17.5 Electric Wiring and Equipment.

Where flammable liquids are dispensed or transferred between containers, electric wiring and equipment must be suitable for classified locations in accordance with NFPA 70. Where flammable liquids are not dispensed or transferred between containers, unclassified locations for electrical equipment may be provided./2/

4-17.6 Ventilation.

4-17.6.1 Ventilation must be provided for all hazardous materials storage areas. Ventilation must meet the requirements of NFPA 400.

4-17.6.2 Fan motors located outside of the hazardous materials storage area are permitted to be classified for ordinary locations in accordance with NFPA 70.

4-17.7 Prefabricated Structures.

Prefabricated structures (portable or permanent) are permitted to store hazardous materials and hazardous waste provided they meet the requirements of NFPA 400.

4-17.8 Outdoor Storage Limitations and Separation.

4-17.8.1 Outdoor storage must comply with all of the following:

4-17.8.1.1 The building or structure must be constructed of noncombustible materials, and,

4-17.8.1.2 Walls must not obstruct more than two sides of the structure, or, walls may obstruct portions of multiple sides of the structure, provided that the sum of the walls does not exceed 50 percent of the structure's perimeter./2/

4-17.8.2 The outdoor storage area must not be more than 400 feet (122 m) long or wide and each area must be separated by 100 feet (30.5 m).

4-17.8.3 No containers or portable tanks in a pile are permitted to be more than 200 feet (61 m) from a 40 feet (12.2 m) wide minimum fire lane.

4-17.8.4 Fire hydrants must be installed in accordance with NFPA 24, but spaced not more than 300 feet (91 m) apart. Provide a minimum of two hydrants located so that protected exposures can be reached through hose runs not exceeding 300 feet (91 m).

4-18 HIGH-RISE BUILDINGS.

4-18.1 General.

High-rise buildings must be provided with smokeproof enclosures. Design and install in accordance with NFPA 101. Design and install stair pressurization in accordance with NFPA 92.

4-18.2 Emergency Command Center.

4-18.2.1 Emergency command centers must comply with the following:

- a. Provided with exterior and interior access.
- b. Enclosed by a 1-hour fire-rated barrier.
- c. Provide a minimum area of 200 ft² (18.5 m²) with a minimum dimension of 10 feet (3 m).

4-18.2.2 In addition to the requirements of NFPA 101, the emergency command center must also include the following:

- a. Air-handling system status indicators and controls.
- b. Fire department control panel for smoke control systems (includes visible status indicators and controls).
- c. Schematic building plans indicating the typical floor plan and detailing the building core, means of egress, fire protection systems, fire-fighting equipment and fire department access.

4-18.3 Fire Service Access Elevators.

When the occupied floor level exceeds 120 feet (36.5 m) above lowest fire department vehicle access, provide at least two fire service access elevators that comply with Fire Service Access Elevator requirements in the IBC.

Mechanical penthouses and mechanical stories are not considered occupied floor levels.

4-18.4 Buildings Greater than 420 feet (128 m).

The provisions of this UFC are not intended to apply to buildings greater than 420 feet (128 m) in height. For buildings exceeding 420 feet (128 m) in height, the *DFPE* must be consulted for any additional requirements.

4-19 HISTORIC FACILITIES.

4-19.1 General.

Projects in historic facilities are expected to meet the requirements of the chapter entitled "Existing Facilities" in this UFC./2/

4-20 HYDRAULIC SYSTEMS.

4-20.1 General.

Any combustible liquids under pressure must be treated as a flammable liquid.

4-20.2 Petroleum-Based Hydraulic Fluids.

4-20.2.1 Provide automatic sprinklers directly over and at least 20 feet (6.1 m) beyond the hydraulic equipment. Complete sprinkler protection is required if the structure is of combustible construction, regardless of floor area. Sprinklers may be omitted near a single small system or multiple adjacent small systems not exceeding 100 gal (380 L) aggregate capacity, and if the construction is noncombustible and ignition sources are not normally present, and provisions exist for automatic or manual shutdown of the system(s).

4-20.2.2 An automatic switch, activated by sprinkler waterflow alarm, fusible link, or other fire detector, must be provided to shut down the hydraulic system if there is 100 gal (380 L) or more aggregate capacity of hydraulic fluid.

4-20.3 Hydraulic Test Systems.

4-20.3.1 For hydraulic systems that use pressures exceeding 200 psi (1380 kPa), SAE 1010 dead-soft, cold-drawn, seamless-steel tubing (or equivalent) must be used. A safety factor of eight over normal working pressure must be used. For systems with working pressures in excess of 2,500 psi (17,240 kPa), a factor of safety of four times the burst pressure is acceptable. Tubing is preferable to pipe. Tubing can be bent to fit in restricted spaces with a minimum number of fittings, reducing the number of possible

leakage points. Solderless, steel fittings of the flareless "locking-sleeve" type or flare type must be used.

4-20.3.2 Use of threaded pipe must be avoided. Where threaded connections are used, requirements of ANSI B1.20.1 must be met. A safety factor of eight over normal pressure must be used.

4-20.3.3 Tubing runs must have as few bends as possible, but must have at least one bend to provide for thermal expansion and contraction. The minimum radius of tube bend must be three tube diameters.

4-20.3.4 Where hose must be used for flexible connections, it must be steel reinforced, designed for the hydraulic fluid being used, and capable of withstanding five times the actual operating pressure. Hose couplings and fittings and minimum bending radius must be in accordance with the hose manufacturer's instructions. Hose must be installed so as not to rub against objects as a result of machine movement, vibration, or pressure surges.

4-20.3.5 Piping and tubing must be anchored or secured to minimize failure due to vibration. Pipe supports must not prevent normal thermal expansion.

4-20.3.6 There must be an accessible, well-marked, emergency shutoff switch for each pump.

4-20.3.7 Provide an automatic shutoff switch to deactivate hydraulic pump upon loss of pressure.

4-21 HYDROELECTRIC GENERATING PLANTS.

4-21.1 Hydroelectric Generating Plants.

Hydroelectric plants must comply with the section in this UFC for "Power Generating And Utilization Equipment" except as modified in this section. Also, hydroelectric plants must comply NFPA 850, especially the chapter for Identification and Protection of Hazards for Hydroelectric Generating Plants, except as modified by this section.

4-21.2 Indoor Transformers

Indoor transformer equipment spaces such as transformer vaults must contain the appropriate fire barrier rating for all partitions and those items installed in the partitions.

4-21.2.1 Automatic fire suppression systems are not required for the following indoor transformers.

- a. Dry type indoor transformers.
- b. FMDS 5-4 "less flammable" fluid filled transformers contained within 3-hour fire rating barriers.

- c. Transformers rated less than 35 kV containing less than 100 gallon capacity and contained within 3-hour fire rating barriers.

4-21.2.2 Automatic fire suppression systems must be provided for all other indoor transformers rated 35 kV or greater and all must be enclosed by 1-hour fire-rated barriers. Fire suppression system type must be one of the following.

- a. Water mist system with operating pressure greater than 175 psi in accordance with NFPA 750.
- b. Clean agent in accordance with NFPA 2001.

4-21.3 Outdoor Transformers.

Structures and equipment in the vicinity of outdoor oil-filled transformers must be protected by separation, fire barriers, or water spray systems.

4-21.3.1 Where outdoor transformers are located on the hydroelectric plant structure and not protected by water spray systems, provide a structural analysis of the exposed supporting and adjacent structure(s) proving that these structure(s) can withstand the design fire without collapse or severe damage. The design fire must be based upon the "Heat Flux Calculations" of ANSI/IEEE 979. Severe damage is defined as that preventing occupancy or facility use following a fire or based upon an estimated repair cost as compared to estimated project cost.

4-21.3.2 Fire barriers may be constructed of materials other than concrete block or reinforced concrete construction where the materials provide 2-hour fire resistance rating. Fire barriers must be designed to resist wind loads.

4-21.3.3 Where outdoor transformers are located on the hydroelectric plant structure containment must be provided for the transformer oil volume plus the 24 hour, 25 year stormwater volume.

4-21.3.4 Automatic fire suppression water spray systems must comply with the following:

- a. The water supply must be adequate for 2 hours of operation of the water spray system at maximum demand. A hose stream demand of 500 gpm (1900 L/min) must only be included for existing facilities with existing hydrants for reuse or replacement.
- b. Containment must be provided for the water volume produced by the water supply for 2 hours of operation.

4-21.4 Hydroelectric Generators.

All hydroelectric generators and ancillary equipment contained in generators must be protected by one of the following automatic fire suppression systems regardless of winding insulation material construction.

- a. High or Low Pressure CO₂ system in accordance with NFPA 12.
- b. Clean Agent in accordance with NFPA 2001.

4-21.5 Oil Storage and Oil Purification Rooms.

Oil storage and oil purification rooms must be protected by one of the following automatic fire suppression systems.

- a. Water mist system with operating pressure greater than 175 psi in accordance with NFPA 750.
- b. Clean Agent in accordance with NFPA 2001.

4-21.6 Paint and Flammable Liquid Storage Rooms.

Paint and flammable liquid storage rooms must be protected with automatic fire suppression as specified for oil storage and oil purification rooms./2/

4-21.7 Fire Alarm.

For fire alarm, detection, and notification systems, provide secondary power under supervisory conditions for 24 hours and all alarm devices for an additional 15 minutes.
/5/

4-22 **HYDROGEN FACILITIES.**

4-22.1 Liquid Hydrogen (LH₂).

Install LH₂ storage and fueling in accordance with NFPA 52 and FM Global Data Sheet 7-91.

4-22.2 Gaseous Hydrogen (GH₂).

Install GH₂ compression, gas processing, and storage in accordance with NFPA 52 and FM Global Data Sheet 7-91.

4-22.3 Indoor Fueling or Dispensing.

Indoor fueling or dispensing of LH₂ or GH₂ is prohibited.

4-23 **HYPERBARIC AND HYPOBARIC CHAMBERS.**

4-23.1 Hyperbaric Chambers.

Hyperbaric chambers must comply with NFPA 99 Chapter entitled "Hyperbaric Facilities". Incorporate criteria contained in UFC 4-159-01N and SS 521-AA-MAN-010 into the design of hyperbaric chambers.

4-23.2 Hypobaric Chambers.

Hypobaric chambers must comply with NFPA 99B.

4-24 LABORATORIES.

4-24.1 General.

Laboratories using chemicals must comply with NFPA 45.

Note: NFPA 45 quantities for flammable and combustible liquids may be proposed to the *AHJ* in lieu of NFPA 1 MAQ/CA.

4-25 HISTORIC RESOURCE LIBRARIES, ARCHIVES, AND FACILITIES.

4-25.1 General.

4-25.1.1 Comply with NFPA 909 or NFPA 232.

For Navy and Marines projects, comply with FC 4-760-10N.

4-25.1.2 Libraries storing materials that are not culturally significant (e.g., primary or secondary school library) are not required to comply with this section.

4-25.1.3 Facilities for the restoration of culturally significant materials must comply with this section.

4-25.1.4 Use noncombustible wall and ceiling finish materials.

4-25.1.5 Provide complete automatic wet pipe sprinkler protection throughout *Facilities* containing libraries.

4-25.1.6 Water mist fire protection systems complying with paragraph entitled "Water Mist Fire Protection Systems" in this UFC may be used in those areas of the *Facility* containing rare or unique materials that are particularly susceptible to water damage.

4-26 LIMITED ACCESS AND UNDERGROUND STRUCTURES.

4-26.1 General.

Comply with the requirements of NFPA 101, except as noted below.

4-26.2 Limited Access Structures.

4-26.2.1 A manually activated smoke exhaust system must be provided for structures three stories or more in height. The smoke exhaust system must be designed for a minimum of six air changes/hour throughout the entire building.

4-26.2.2 Provide complete automatic sprinkler protection for all limited access structures regardless of floor area or construction type.

4-26.3 Underground Structures.

4-26.3.1 A manually activated smoke exhaust system must be provided when there are two or more occupied levels or when an occupied level is greater than 30 feet (9.1 m) below grade plane. The smoke exhaust system must be designed for a minimum of six air changes/hour throughout underground occupied levels.

4-26.3.2 Provide complete automatic sprinkler protection for all occupiable underground structures regardless of floor area or construction type.

4-27 MEDICAL FACILITIES.

These facilities must conform to UFC 4-510-01 and NFPA 101.

4-28 MILITARY OPERATIONS ON URBAN TERRAIN (MOUT) TRAINERS.

The DFPE must be consulted during the planning phase to determine what specific fire protection and life safety requirements are necessary.

Note: These structures are unique as they can be designed and constructed to mimic conditions in other locations. Guidance can be found in NFPA 101 for Special Amusement buildings.

4-29 MISSILE ALERT FACILITIES (MAF).

4-29.1 Sprinkler Protection.

Protect all missile alert facilities with a sprinkler system designed and installed in accordance with NFPA 13R. Systems must be supplied from the existing domestic water storage tank; a separate water storage tank is not required. Use dry pendent or dry sidewall heads for rooms/spaces exposed to freezing temperatures.

4-29.2 Heat Detectors.

Thermal detection devices must be provided in rooms, areas and spaces that are not protected by automatic sprinkler protection in accordance with NFPA 13R.

4-29.3 Fire Hydrants.

Provide a dry fire hydrant installed on the domestic water tank to allow local fire departments the ability to draft firefighting water during emergencies.

4-30 MORALE WELFARE AND RECREATION FACILITIES (MWR).

Clubs, bowling centers, craft shops (including hobby shops, woodworking, auto centers) and similar recreational facilities with an occupant load of 50 or more must be protected with automatic sprinkler systems regardless of floor area or construction type.

4-31 NATURAL GAS SERVICE.

4-31.1 General.

4-31.1.1 Gas service mains must be installed in accordance with NFPA 54 and NFPA 58.

4-31.1.2 Gas service mains are not permitted within the perimeter of foundation lines.

4-31.1.3 Provide natural draft cross ventilation for *Facility* crawl spaces containing gas service piping.

4-31.1.4 Raise supply connections from the gas service mains above grade outside the foundation wall\2\./2/

4-31.1.5 Locate pressure regulators outside of the *Facility* or vent to the outside away from air intakes.

4-32 \2\NAVIGATION LOCKS \5\AND LAKE PROJECTS\5/.

\5\This section applies to navigation locks and dams on rivers and other waterways, as well as operating control towers at lake projects.

4-32.1 General.

4-32.1.1 Protection of Petroleum Based Hydraulic Fluid Power Equipment and Hydraulic Fluid Reservoir. Protect hydraulic reservoir and pumping equipment with fire suppression system or separate from remainder of facility by fire barrier walls. A fire suppression system must be an automatic sprinkler, water mist, clean agent, or other suppression system approved by DFPE. Fire barrier walls must be 2-hour rated concrete construction with opening protection.

4-32.2 Navigation Locks./5/

4-32.2.1 Pump Requirements.

Two fire water pumps of the equal size are required, one of which must be redundant. Pump sizing must be based on either the gate spray sprinkler systems or hose stations, whichever is greater. Minimum pump design flow must be 250 gpm, to serve the five hose stations with each flowing 50 gpm. The minimum pump pressure must be 100 psi, and increased as required to provide at least 60 psi at each hose station.

4-32.2.2 Hose Station Requirements.

Hose stations in accordance with NFPA 14 must be located 25 feet upstream and downstream of each gate. These hose stations must be equally spaced at no more than 300 feet intervals along the walls on both sides of the lock chamber. Hose stations will consist of 150 feet of hose in a permanent cabinet. Hose must be 1-1/2 inch synthetic lined and conform to NFPA 1961.

4-32.2.3 Miter Gate Spray System Requirements.

Miter gates (upstream and downstream in lock chamber) must be fitted with a fixed gate spray sprinkler system for coverage of 0.25 gpm/sf of gate. Spray nozzles in accordance with NFPA 15 must be open type with a flat spray pattern operating at 45 psi and a minimum angle of 50 degrees. Nozzle must be brass or stainless steel and sized and spaced to provide complete coverage. Sprinkler piping and bracing must be stainless steel in accordance with NFPA 13 and protected against damage. Connect gate piping with a stainless steel swivel joint with stainless steel ball bearings and grease fittings for lubrication and installed to completely drain. Gate spray system must be separated from hose stations, using a motorized valve.

4-32.2.4 Aboveground Piping Requirements.

Aboveground piping and embedded pipe must be corrosion resistant and in accordance with ASTM A312, Schedule 40. All fittings must have a minimum rated working pressure of 175 psi.

4-32.2.5 Underground Piping Requirements.

Underground piping must be cement-mortar lined ductile-iron with a 150 psi working pressure and in accordance with AWWA C151 and C104. Pipe will be polyethylene encasement in accordance with AWWA C105.

4-32.2.6 Fire Alarm System Requirements.

Provide a fire alarm system in accordance with NFPA 72. The system must consist of an outside electric horn with alarm switches located strategically throughout the project. Electric power for the alarm must be taken from the house-current supply line on the line side of the main switch through an independent switch and circuit breaker. Provide automatic dialers, to facilitate a quick emergency response.

4-32.2.7 Supply Water Intake Requirements.

Water supply to fire pumps may be from the river. If the area is contaminated by zebra mussels, then the fire pump intake must have suitable control strategies implemented. Provide intakes with double type strainers and exterior stainless steel screens./2/

4-33 **ORDNANCE.**

4-33.1 *Installation Ordnance Facilities.*

4-33.1.1 Sprinkler protection must be provided for *Installation Ordnance Facilities*.

4-33.1.2 Munitions storage igloos that are in accordance with DoD explosive safety standards and accessory magazines at security and police stations are not required to comply with this section.

4-33.1.3 Water demand for other *Ordnance Facilities* must meet or exceed the design requirements for extra hazard as described in this UFC.

4-33.1.3.1 For Navy and Marine projects, refer to NAVSEA OP-5 for water demand.

4-33.1.4 For Air Force projects, refer to AFMAN 91-201.

4-33.2 *Ammunition/Explosives (A/E) Storage Facilities.*

4-33.2.1 *A/E storage Facilities* are permitted to be either Earth Covered Magazines (ECM) or Above Ground Magazines (AGM) as defined by DESR 6055.09. An *A/E storage Facility* is used for *A/E storage* only. The *storage Facility* must not be used for handling, processing, testing, servicing, and inspection of ammunition, explosives, propellants, and oxidizers or joint use of storage and the handling, processing, testing, servicing, and inspection of ammunition, explosives, propellants, and oxidizers.

4-33.2.2 *A/E storage Facilities* must be constructed and located ("sited") in accordance with DESR 6055.09.

4-33.2.3 Automatic sprinklers and hydrant protection are not required for *A/E storage Facilities*.

4-33.2.4 Compliance with IBC or NFPA 101 is not required for *A/E storage Facilities*.

4-33.3 *Stored Missile Assemblies.*

Missile assemblies are considered to be large rocket type, Cruise missiles without their ordnance, Intercontinental Ballistic Missiles, or Poseidon missiles.

4-33.3.1 Provide sprinkler protection for all stored missile assemblies.

4-33.3.1.1 Munitions storage igloos that are in accordance with DoD explosive safety standards are not required to be provided with sprinkler protection.

4-33.3.2 Water demand for stored missile assemblies and all other ordnance facilities requiring sprinkler protection must meet or exceed the design requirements for Ordinary Hazard in Chapter 9.

4-33.3.2.1 For Air Force projects, refer to AFMAN 91-201, Explosives Safety Standards.

4-33.4 Other *Ordnance Facilities*.

4-33.4.1 All other *Ordnance Facilities* including munitions, weapons, and missile maintenance facilities require sprinkler protection.

4-33.4.2 Water demand for other *Ordnance Facilities* must meet or exceed the design requirements for Ordinary Hazard in Fire and Smoke Protection Features chapter.

4-33.4.3 For Air Force projects, refer to AFMAN 91-201, Explosives Safety Standards.

4-33.5 *Ordnance Production Facilities*.

4-33.5.1 *Ordnance Facilities* used for manufacturing, maintaining, demilitarizing, handling, processing, testing, servicing, and inspection of ammunition, explosives, propellants and oxidizers or related devices containing these materials must have complete automatic sprinkler protection and comply with DESR 6055.09.

Note: These facilities are often known as "ammunition plants / depots".

4-33.5.2 The applicable requirements of the IBC for Group H occupancies must be followed in the absence of specific guidance in DESR 6055.09 and the individual service regulations based directly on DESR 6055.09. The service regulations include:

- For Navy projects, NAVSEA OP-5.
- For Army projects, Army AR 385-64; U.S. Army National Guard NGR 385-64; and the Army Material Command Regulation 385-100.
- For Air Force projects, Air Force AFMAN 91-201.

4-33.5.3 Risk Assessment.

All munitions production, maintenance, renovation, quality assurance and demilitarization operations will receive a risk assessment to identify potential fire and thermal threats and to assess the level of risk. The hazard must be accurately defined. A potential fire or thermal hazard whose level of risk is high or extremely high is unacceptable. The risk assessment will consider factors such as:

- a. Initiation sensitivity.
- b. Quantity of material.
- c. Heat output.
- d. Burning rate.
- e. Potential ignition and initiation sources.

- f. Protection capabilities.
- g. Personnel exposure.
- h. Munitions configuration.
- i. Process equipment.
- j. Process layout.
- k. The building layout.

4-33.5.4 Sprinkler Protection.

4-33.5.4.1 Complete automatic sprinkler protection is required for *Ordnance Facilities* used for manufacturing, maintaining, demilitarizing, handling, processing, testing, servicing, and inspecting of ammunition, explosives, pyrotechnics, propellants, and oxidizers or related devices containing these materials, unless such a system will aggravate the hazard.

Note: Automatic sprinkler protection is appropriate for the protection of munitions marked "Apply No Water". "Apply No Water" is intended to prevent the manual application by fire extinguisher or fire service hose stream.

4-33.5.4.2 Automatic sprinkler systems in *Ordnance Facilities* must be protected from movement in accordance with NFPA 13 for protection of piping where subject to earthquakes, regardless of seismic design category.

4-33.5.4.3 Where exposed thermally energetic materials are handled that have a high probability of ignition, a large thermal output and a high probability of causing personnel injury, operations must be protected using ultra-high-speed deluge systems. Ultra-high-speed deluge systems have a response time of 100 milliseconds (ms) or less. Response time is measured from the time that an energy source is presented to the detector to the time of initial water flow from the critical nozzle, which is normally the nozzle closest to the hazard. Ultra-high-speed detectors usually consist of a preprimed water delivery system, optical flame detectors, and electronic controller. The paragraph entitled "Ultra-High-Speed Deluge Systems" provides guidance on ultra-high-speed deluge systems.

Note: NFPA 15 and the NFPA Handbook provide additional information on ultra-high-speed deluge systems.

4-33.5.4.4 Provide high-speed (operation of 500 ms or less), preprimed deluge systems wherever exposed explosives, pyrotechnics, or propellants are processed or stored in ordnance production facilities. Complete protection of such locations is essential.

4-33.5.4.5 Provide ordinary deluge systems or wet pipe systems in other areas or auxiliary sections of *Facilities* where processing of explosives, pyrotechnics, or propellants takes place.

4-33.5.4.6 Provide ordinary deluge systems or wet pipe systems in other areas or auxiliary sections of *Facilities* where storage of explosives or propellants takes place.

4-33.5.4.7 Provide wet pipe sprinkler systems in other areas or auxiliary sections of *Facilities* if separated by fire barriers.

4-33.5.4.8 Provide wet pipe sprinkler systems where missile assembly, inspection, or storage is carried on and where the propellant is confined within the missile, or warheads are present. Similar protection must be provided for torpedo and air underwater weapons shops.

4-33.5.5 Heat detection equipment of any type is acceptable if equipment meets the operating time limitations and is suitable in other respects, such as complying with explosion-proof requirements. When pneumatic-type detection equipment is used, not more than three detectors, and preferably only one, must be on a single circuit in the same heat influence area.

4-33.5.6 All fire protection systems protecting ordnance operations must have complete supervision so that any deficiency that develops that would affect the speed or reliability of operation will give a distinct alarm separate from the waterflow alarm.

4-33.5.7 Ultra-High-Speed Deluge Systems.

Comply with the requirements of NFPA 15, except as noted in this standard.

4-33.5.7.1 Response Time.

- a. Response time must be the time for system operation from the presentation of an energy source at the detector to flow of water from the water spray nozzle.
- b. Ultra-high-speed deluge systems must be designed to have a response time of not more than 100 ms, unless a risk assessment or other data indicates a need for a faster response time.

4-33.5.7.2 Timers.

- a. Timers or similar devices to stop waterflow after a predetermined time are permitted if they are fail-safe (i.e., water continues to flow in the event of a timer failure).
- b. Timers or similar devices that shut off the waterflow after a predetermined time (typically 1 to 2 minutes) when the optical fire detectors no longer detect a fire are permitted. In case of a failure, it must be fail-safe.

4-33.5.7.3 Design.

Due to the speed of water coming from all the nozzles, ultra-high-speed deluge systems depend on the detection system, piping network, nozzles and water supply characteristics. Only designers, engineers, and installers who are knowledgeable of the system's limitations and capabilities must provide the design, specification, and installation of the deluge system.

4-33.5.7.4 Water Demand.

Water supplies for ultra-high-speed deluge systems must be adequate to supply the total demand of the largest *Fire Area* at the specific residual pressure required by the system for a period of at least 15 minutes unless a hazard analysis indicates a longer flow time is needed. Provide a flow rate of at least 0.50 gpm/ft² (20.4 L/m/m²) over the entire area protected by the ultra-high-speed deluge system unless a hazard analysis indicates a higher flow rate is needed.

4-33.5.8 Small Self-Contained Deluge Systems.

Note: Currently, two types of small self-contained deluge systems are in use in military *Ordnance Facilities*. They may be used with the ultra-high-speed deluge systems discussed in this section, or alone if an adequate water supply is not available for the *Facility*. These small self-contained deluge systems are primarily intended for personnel protection, although they provide some building/equipment protection.

4-33.5.8.1 When used, self-contained deluge systems must be connected to the existing water supply.

4-33.5.8.2 Portable, self-contained ultra-high speed deluge system must meet the following:

- a. Multiple nozzles.
- b. Multiple optical fire detectors.
- c. Pressurized water tank (typically 100 gal (380 L) of water).
- d. Response time must not exceed 100 ms (detection to water at the nozzle).

Note: The portable system is intended to protect short-term operations.

4-33.5.8.3 Pressurized sphere ultra-high-speed deluge system must meet the following:

- a. One or more optical fire detectors.
- b. At least one pressurized (typically 500 psi (3,447 kPa)) water sphere (typically 2.6 to 7.9 gal (10 to 30 L)) with a rupture disc and internal squib, and an electronic controller.
- c. Response time must be less than 10 ms (detection to water at the nozzle).

4-34 OXYGEN.

4-34.1 General.

4-34.1.1 Comply with NFPA 55 and NFPA 400, except as modified by this UFC.

4-34.2 Gaseous oxygen (GOX).

4-34.2.1 Bulk GOX Systems.

4-34.2.1.1 Comply with provisions of NFPA 55 for the installation and location of bulk GOX.

4-34.2.1.2 Bulk GOX must be located either above ground and outdoors, or installed in a building of fire-resistant construction that is adequately vented and is used exclusively for storing GOX.

4-34.2.1.3 Containers and associated equipment for Bulk GOX should not be located beneath or be exposed to the failure of electric power lines or piping containing any flammable liquid or gas.

4-34.2.2 GOX System Design.

4-34.2.2.1 GOX systems must be designed to control potential ignition energy mechanisms.

4-34.2.2.2 Automatic safety devices such as system safety valves, flow regulators, and equipment safety features must be installed to automatically control hazards.

4-34.2.2.3 Alarms and warning systems must monitor the parameters of the storage, handling and use of GOX that may endanger personnel and cause property damage.

4-34.2.2.4 System flow velocity in GOX must not exceed 100 feet/second.

4-34.2.2.5 Quick-acting valves must not be used to start or stop GOX systems.

4-34.2.2.6 Remotely operated shutoff valves must be operated only using inert gas or air, and oxygen gas must never be used to operate valves.

4-34.3 Liquid Oxygen (LOX).

4-34.3.1 Liquid Oxygen Tanks.

4-34.3.1.1 Comply with the applicable provisions of NFPA 51 and NFPA 99, regardless of occupancy.

4-34.3.1.2 Fixed tanks having combined capacity of 100 gal (380 L) or less or portable tanks, must comply with applicable provisions NFPA 51 and NFPA 99, regardless of occupancy.

4-34.3.1.3 Where tanks have a single or combined capacity of more than 100 gal (380 L), tanks must be fixed except as modified in the paragraph entitled "Oxygen Bulk Tanks".

4-34.3.2 Oxygen Bulk Tanks.

Use fixed bulk tanks or portable high-pressure bulk units having a single or combined capacity of more than 100 gal (380 L) that conform to NFPA 55 and NFPA 99 except as modified below:

4-34.3.2.1 Locate bulk oxygen storage out of doors or in a detached noncombustible structure used solely for this purpose and separated as follows:

- a. 75 ft (23 m) from:
 - 1) Aboveground ignitable-liquid tanks of 1,000 gal (3.8 m³) or greater capacity.
 - 2) Aboveground tanks of liquefied flammable gases of over 1,000 gal (3.8 m³) aggregate water capacity.
 - 3) Low-pressure flammable-gas storage holders of 5,000 ft³ (140 m³) or greater capacity.
 - 4) Unsprinklered combustible buildings.
 - 5) Combustible yard storage.
 - 6) Wood exterior walls.
- b. 25 ft (7.6 m) from:
 - 1) Aboveground ignitable-liquid tanks of less than 1,000 gal (3.8 m³) capacity.
 - 2) Aboveground tanks of liquefied flammable gases of 1,000 gal (3.8 m³) or less aggregate water capacity.
 - 3) Filling or vent connections to underground ignitable liquid tanks.
 - 4) Low-pressure flammable-gas storage holders of less than 5,000 ft³ (140 m³) capacity.
 - 5) Sprinklered buildings or buildings with both noncombustible construction and light or ordinary hazard occupancy.
 - 6) High-pressure bulk flammable-gas storage.
 - 7) Ignitable-liquid unloading stations.
- c. 5 ft (1.5 m) from:

- 1) 1) Noncombustible construction having blank walls 10 ft (3 m) above and 10 ft (3 m) on each side of the equipment.

4-34.3.2.2 Regulators and other control equipment are permitted to be located indoors in a noncombustible building detached or cut off from main buildings or combustible storage. Cutoffs should have at least a 1 hour fire resistance rating.

4-34.3.2.3 Locate outdoor oxygen-storage equipment on a base of crushed stone or concrete./2/

4-34.3.3 \2\Storage/Parking of LOX Carts/2/.

Separation distances for LOX \2\2/carts are as follows:

4-34.3.3.1 A minimum of 100 feet (30.5 m) from aircraft parking, fueling, or servicing areas.

4-34.3.3.2 A minimum of 100 feet (30.5 m) from any flammable or combustible liquids handling, servicing, processing, or storage area.

4-34.3.3.3 A minimum of 50 feet (15.3 m) from any building.

4-34.3.4 \2\Parking of LOX Vehicles/2/.

Parking for \2\LOX/2/ vehicles that service fixed tanks must be designed in accordance with the separation requirements of NFPA 55 for fixed bulk tanks except as modified in the paragraph entitled "\2\ Storage/Parking of LOX Carts"/2/.

4-34.3.5 LOX Storage for Propellant Applications.

Use liquid oxygen storage for propellant applications that comply with 29 CFR 1910.109 except as modified in the paragraph entitled "LOX Tank and Cart Storage/Parking".

4-34.4 Combined LOX and GOX *Facilities*.

LOX and GOX can use the same *Facility* provided they meet the requirements for each.

4-35 PERSONNEL HOUSING AND SIMILAR LODGING FACILITIES.

4-35.1 General.

This section is applicable to all personnel housing and similar lodging facilities where sleeping occurs, regardless of the number of occupants sleeping.

Note: These facilities are commonly referred to as *Billeting* and include barracks, dormitories including apartment style, lodges, temporary or transient living facilities, and sleeping quarters. For duty, and similar rooms, see "Fire and Smoke Protection Features" chapter.

4-35.2 Automatic Sprinkler Protection.

Complete automatic sprinkler protection must be provided, regardless of floor area or construction type.

4-35.3 Smoke Detection.

4-35.3.1 Provide smoke detectors in accordance with NFPA 101.

4-35.3.2 A smoke detector must be provided for each sleeping room and the shared/common space of a suite regardless of occupancy or the presence of other detection or protection systems in the *Facility*.

4-35.3.2.1 Upon detection of smoke, an audible signal must be activated in all sleeping rooms and the shared/common space(s) within the *Dwelling Unit*, send a distinct sleeping room smoke detector signal to the *Facility* fire alarm control panel and to the *Installation* fire reporting system, but not activate the *Facility* notification appliances.

Note: The signal to the FACP and fire reporting system may be an alarm or supervisory signal, as determined by the *DFPE*.

4-35.3.2.2 The audible signal in the dwelling unit must be low frequency as required by NFPA 72.

4-35.3.3 Primary and secondary power for the smoke detectors must be provided from the fire alarm control panel. Detectors that are not powered from the fire alarm control panel are not permitted.

4-35.3.4 Activation of a smoke detector in a room dedicated as an ABA/ABAAG accessible room must also activate all visible notification appliances in the room.

4-35.3.5 Sounder bases must not be provided in open sleeping bays with voice evacuation notification. Activation of smoke detector in open sleeping bays must activate building-wide notification appliances.

4-35.4 Cooking Areas.

4-35.4.1 A range top extinguishing system is not required for cooking equipment provided with residential appliances in fully sprinklered *Facilities*. This applies to both the *Dwelling Units* and in common areas.

4-35.4.2 In non-sprinklered areas, a range top extinguishing system must be provided for cooking equipment, regardless of the location in the building.

4-36 PESTICIDE STORAGE AND HANDLING FACILITIES.

4-36.1 General.

4-36.1.1 Locate facilities or operations involving the storage, mixing, or handling of non-flammable pesticides a minimum of 100 feet (30.5 m) from the nearest *Facility* or occupied structure.

4-36.1.1.1 Facilities of Type I construction as defined by the IBC, may be located less than 100 feet (30.5 m) from the nearest *Facility* or occupied structure, but not less than 30 feet (9.1 m) in any case.

4-36.1.1.2 Facilities protected by an automatic sprinkler system may be located less than 100 feet (30.5 m) from the nearest *Facility* or occupied structure, but not less than 30 feet (9.1 m) in any case.

4-36.1.2 Existing facilities involving the storage, mixing, or handling of non-flammable pesticides are permitted in a *Facility* when all the following are provided:

- a. The *Facility* is completely protected, including the pesticide area, by an automatic sprinkler system.
- b. The pesticide area is separated by not less than one-hour fire-rated construction from the remainder of the *Facility*.

4-36.1.3 Comply with local environmental regulations related to containment of fire sprinkler water discharge.

4-37 PETROLEUM, OILS & LUBRICANTS (POL) FACILITIES.

4-37.1 General.

4-37.1.1 Petroleum fuel facilities consist of but not limited to facilities that receive, store, distribute, or dispense liquid fuels. This includes all storage tanks from bulk storage tanks to individual storage tanks and includes fuel tanks supporting diesel generators, day tanks, and protected aboveground tanks.

4-37.1.2 POL *Facilities* must comply with UFC 3-460-01.

4-37.1.3 Warehouses that store flammable or combustible liquids, regardless of container size or configuration, must comply with the requirements in this UFC.

4-37.2 Fuel Testing Laboratories.

Laboratories must comply with the requirements of UFC 3-460-01 and NFPA 45.

4-37.3 Fuel Piers.

Protection for piers with fixed piping systems used for the transfer of flammable or combustible liquids must be in accordance with the following:

- a. UFC 4-152.01.

- b. UFC 4-150-02.
- c. NFPA 30.
- d. NFPA 30A.
- e. NFPA 307 (if liquids are handled in bulk quantities across general purpose piers and wharves).
- f. "Guide on Marine Terminal Fire Protection and Emergency Evacuation", Oil Companies International Marine Forum.

4-38 POWER GENERATING AND UTILIZATION EQUIPMENT.

4-38.1 Power Generating Plants.

Power generating plants must comply with NFPA 850.

4-38.2 Substations.

4-38.2.1 Comply with NFPA 70, NFPA 850 and FMDS 5-4.

4-38.3 Stationary Combustion Engines, Gas Turbines, and Generators.

Internal combustion engines, gas turbines, and generators must comply with NFPA 37 and NFPA 110.

4-38.4 Indoor Transformers.

Indoor transformers must be installed and located in accordance with NFPA 70.

4-38.5 Outdoor Transformers.

4-38.5.1 Outdoor Transformers must be installed and located in accordance with NFPA 70 and ANSI/IEEE 979, except as modified by this UFC.

4-38.5.2 Where transformers are located on or above noncombustible roofs, suitable curbed and drained concrete mats or welded steel plates must be underneath units and located so as not to expose roof structures.

4-38.5.3 Oil-filled transformers must not be installed on combustible roofs.

4-38.5.4 Buildings or equipment exposed by outdoor liquid-insulated transformers must be protected either by separation, a fire barrier, or automatic fire suppression.

4-38.5.4.1 When separation is utilized, the separation distance between *Facilities* and transformers must be as indicated in Table 4-4. The horizontal distance is measured from the edge of the transformer to the *Facility*.

4-38.5.4.2 The separation distance between other equipment (including adjacent transformers) must be as indicated in Table 4-5.

4-38.5.4.3 When fire barriers are utilized, comply with the following:

- a. Barriers must be of concrete block or reinforced concrete construction adequate for 2-hour fire resistance.
- b. The exposed wall must extend the horizontal and vertical distances from the transformer specified in Table 4-4.
- c. Roofs exposed to oil-insulated transformers must be Class A rated for the horizontal distance noted in Table 4-4 for non-combustible construction.
- d. For equipment, barriers must extend 1-foot (305 mm) vertically and 2 feet (610 mm) horizontally beyond transformer components that could be pressurized as the result of an electrical fault. This will typically include bushings, pressure relief vents, radiators, tap changer enclosures, and other similar devices.

4-38.5.4.4 When automatic fire suppression is utilized, it must comply with the following:

- a. A discharge density of 0.30 gpm/ft² (12.2 L/min/m²) must be provided over transformer surfaces, except areas under the transformer.
- b. The water supply must be adequate for 2 hours and must include a hose stream demand of 500 gpm (1900 L/min).
- c. Components of the water spray system, such as piping, spray nozzles, and other components must be a minimum of 18 in. (0.45 m) from the transformer.
- d. Piping must not pass over the top of the transformer or be exposed by tank relief vents.
- e. Do not direct water spray nozzles at bushings.
- f. For multiple transformer installations, the water spray system must be designed based on simultaneous operation of the water spray systems for the transformers not meeting the separation distances of Table 4-4.
- g. When the ground around the transformer is non-absorbing, water spray must be provided at a density of 0.30 gpm/ft² (12.2 L/min/m²) for the diked area or for a distance of 10 feet (3 m) from the transformer in all directions.

4-38.5.4.5 When utilizing fire barriers or automatic fire suppression, the following additional requirements must be applied:

- a. There must be no window openings in first-story walls within a horizontal distance of 10 feet (3 m) from the transformers. Existing window openings must be closed using brick or concrete block.
- b. Overhanging eaves, where they exist, must be noncombustible.

Table 4-4 Separation Distance Between Outdoor Insulated Transformers and Buildings

Liquid	Liquid Volume gal (m ³)	Horizontal Distance ^a			Vertical Distance ft. (m)
		2-hr Fire-Resistant Construction ft. (m)	Non-Combustible Construction ft. (m)	Combustible Construction ft. (m)	
Less Flammable	≤10,000 (37.9)	5 (1.5)	5 (1.5)	25 (7.6)	25 (7.6)
	>10,000 (37.9)	15 (4.6)	15 (4.6)	50 (15.2)	50 (15.2)
Mineral Oil	<500 (1.9)	5 (1.5)	15 (4.6)	25 (7.6)	25 (7.6)
	500 - 5,000 (1.9 - 19)	15 (4.6)	25 (7.6)	50 (15.2)	50 (15.2)
	>5,000 (19)	25 (7.6)	50 (15.2)	100 (30.5)	100 (30.5)

^a If FM-approved transformers are used; the separation distances must follow the requirements of FM Global Data Sheet 5-4, which allows for reduced separation distances.
Less Flammable: See NFPA 70.

Table 4-5 Separation Distance Between Outdoor Fluid Insulated Transformers and Equipment (Including Other Transformers)

Liquid	Fluid Volume gal (m ³)	Distance ft. (m)
Less Flammable	≤10,000 (37.9)	5 (1.5)
	>10,000 (37.9)	25 (7.6)
Mineral Oil	<500 (1.9)	5 (1.5)
	500 - 5,000 (1.9 - 19)	25 (7.6)
	>5,000 (19)	50 (15.2)
Less Flammable: See NFPA 70.		

4-39 **51** PRIVACY PODS OR PRIVACY ENCLOSURES.

Privacy pods or privacy enclosures (pods) are freestanding enclosures and typically used as a lactation space, temporary private office, sound enclosure, counseling space, or similar use.

4-39.1 Sprinkler Protection.

Pods can be an obstruction to the water distribution rules for automatic sprinklers in the space or room they occupy. Pods must follow Table 4-5a.

TABLE 4-5a Pods Sprinkler Logic Table

INPUTS			RESULTS		
Pod Size*	Pod Ceiling	Room Sprinklers (external to Pod)	Sprinkler Required In Pod	Modify Room Sprinklers	No Room Sprinkler Modification
Small	Open	Obstructed		X	
Small	Open	Unobstructed			X
Small	Enclosed	Obstructed		X	
Small	Enclosed	Unobstructed			X
Large	Open	Obstructed		X	
Large	Open	Unobstructed			X
Large	Enclosed	Obstructed	X	X	
Large	Enclosed	Unobstructed	X		

* Small pod has a silhouette projected on the floor less than 25 ft² (2.3 m²).
Large pod has a silhouette projected on the floor equal to or greater than 25 ft² (2.3 m²).

4-39.1.1 Open-Grid Ceiling.

Open-grid ceiling is defined in NFPA 13. The open-grid ceiling must cover a minimum of 75% of the pod's silhouette area to be considered as an open ceiling in Table 4-5a.

4-39.1.2 Grouping: Pods separated by less than 4 feet (1.2 m) are considered a group. The size of the group will be determined by the area of the pods, plus the area between the pods. A group of pods having a total area less than 75 ft² (7.0 m²) will follow the requirements of Table 4-5a; otherwise, a sprinkler must be installed inside of each pod in that group.

4-39.2 Fire alarm.

Pods must meet the notification requirements, either audibility or visual, for a fire alarm system; otherwise, a visual notification appliance must be installed inside the pod.

4-39.3 Life Safety.

The location of pods, including door swing, must not impede or protrude into the required means of egress. /5/

[C] 4-39.3

Example: If a 72-inch (1.8 m) wide corridor has a required egress width of 44-inches (1.1 m) and a 24-inch (0.61 m) wide pod with a door that swings full 180 degrees is located in the corridor, there is no compromise of the means of egress; however, a 36-inch (0.91 m) wide pod, or a pod with a 90 degree door swing would not be acceptable.

4-40 RANGES AND REMOTE LOCATIONS.

4-40.1 \2\Water Supply.

When the *AHJ* determines a water supply is necessary for the range or remote location, follow the method of calculating minimum water supply as defined in NFPA 1142.

4-40.2 \4\Facilities.

FEMA approved freestanding "FEMA Tank and Pump System (TPS)" or internal "Next Generation FEMA Tank and Pump System (TPS)" are acceptable for use for fixed and relocatable facilities. Installation of the sprinkler system must comply with NFPA 13D./4/

4-40.3 Fire Department Vehicle Access.

Ranges and other remote locations are not required to meet the requirements of the "Fire Department (Emergency) Vehicle Access" section of this UFC or NFPA 1141./2/

4-41 RELOCATABLES.

4-41.1 General.

4-41.1.1 Relocatable facilities must have the same fire protection \2\and/2/ construction \2\2/requirements as non-relocatable facilities.

4-41.1.2 Provide a minimum separation of 50 feet (15.3 m) between groups of high hazard occupancies, as defined by NFPA 101 and 15 feet (4.6 m) for all other groups.

Note: For Navy, refer OPNAVINST 11010.33 for regulations and restrictions on the use of relocatable facilities.

4-41.2 Location.

4-41.2.1 Do not group critical relocatable facilities, such as electronic equipment vans, to form areas greater than 6,000 ft² (557 m²) for non-sprinklered facilities and 12,000 ft² (1,115 m²) for sprinklered facilities.

4-41.2.2 Do not group relocatable facilities having high hazard occupancies, as defined by NFPA 101, to form areas greater than 4,000 ft² (372 m²) for non-sprinklered facilities and 8,000 ft² (743 m²) for sprinklered facilities.

4-42 SENSITIVE COMPARTMENTED INFORMATION FACILITY (SCIF).

4-42.1 General.

Note: SCIF's should not be confused with radio-frequency shielded enclosures and/or anechoic chambers.

4-42.1.1 See UFC 4-010-05 for additional information.

4-42.1.2 As part of the initial design process for a SCIF, the Certified TEMPEST Technical Authority (CTTA) and the security Accrediting Official (AO) must establish both TEMPEST and physical security building element controls prior to designing means and methods of implementing fire protection systems into the SCIF.

4-42.2 Physical Security Door Hardware.

4-42.2.1 All security door hardware installed on a means of egress door, must comply with the provisions of NFPA 101.

4-42.2.1.1 Sliding deadbolts are strictly prohibited.

4-42.2.1.2 A spin-dial combination lock, similar to the Lockmaster CDX-10, equipped with a life safety push-button feature, is acceptable provided the button feature is enabled at all times the SCIF is occupied.

4-42.2.1.3 Door personnel "access control systems" must not restrict free egress at all times. Badge ID readers may be installed on the interior side of a door for personnel "audit" purposes only, but must not be connected to any physical security door hardware (i.e. electric door strikes, magnetic locks, etc.) that would restrict single-motion door operation.

4-42.3 Fire Alarm and Mass Notification System (MNS).

4-42.3.1 See UFC 4-010-05 for requirements pertaining to the installation of fire alarm and MNS devices within a SCIF.

4-42.3.2 Self-amplified fire alarm audio speakers, and associated wiring circuits, can be installed within a SCIF with concurrence of the CTTA.

Note: Self-amplified speakers are limited to 0.5 - 24VRMS audio input signal levels. Typically, most fire alarm voice systems are designed for 70.7VRMS audio circuits, and therefore careful economic consideration must be made on how to introduce the fire alarm audio signals into a SCIF.

4-42.4 Fire Sprinkler Systems.

4-42.4.1 See UFC 4-010-05 for requirements pertaining to the installation of fire sprinkler piping penetrations into a SCIF.

4-42.4.2 Any security mitigation method imposed directly on a sprinkler pipe must comply with NFPA 13.

4-42.4.3 Metallic dielectric unions or grounding clamp(s) and wire(s) are permitted.

4-43 TENSIONED-MEMBRANE STRUCTURES.

4-43.1 General.

4-43.1.1 Tensioned-membrane (fabric) structures must meet the requirements of NFPA 101 and NFPA 102 as well as all life safety, fire protection, and allowable area requirements for the specific occupancy, in accordance with the other provisions of this UFC.

4-43.1.2 Tensioned-membrane (fabric) structures must also meet the requirements of the applicable use paragraph in this UFC.

4-43.1.3 \5When this section or other applicable use paragraphs in this UFC require the installation of sprinkler or other fire protection features, the requirements must be identified in the tension-membrane structure procurement documents to ensure the structural elements are adequately designed to support the dead and live loads of the fire protection features.

4-43.2 /5/Allowable Area and Separation Distance.

4-43.2.1 Table 4-6 provides the maximum allowable area and separation requirements for all tension fabric structures intended to exceed 12 months of use.

4-43.2.2 The separation area must be a clear zone adjacent to the tension fabric structure.

4-43.2.2.1 The clear zone cannot be used for storage and must be clear of vegetation (maintained lawn is permitted).

4-43.2.2.2 The clear zone may be used as a street or driveway, but not for vehicle parking.

Note: For Navy, see OPNAVINST 11010.33 for regulations and restrictions on the use of relocatable facilities.

Table 4-6 Basic Allowable Area for Tensioned-Membrane/Fabric Structures

SEPARATION DISTANCE	TYPE of CONSTRUCTION - In Square Feet (Square Meters)			
	Noncombustible Material		Combustible Material	
	Sprinkler Protection	No Sprinkler Protection	Sprinkler Protection	No Sprinkler Protection
20 feet (6 m)	36,000 (3,344)	12,000 (1,114)	24,000 (2,229)	8,000 (743)
40 feet (12 m)	72,000 (6,689)	24,000 (2,229)	48,000 (4,459)	16,000 (1,486)
60 feet (18 m)	UNLIMITED	UNLIMITED	UNLIMITED	UNLIMITED

4-43.3 Tensioned-Membrane (Fabric) Hangars.

Tensioned-membrane (fabric) hangars must comply with the paragraph entitled "Aircraft Facilities".

4-44 TRASH/RECYCLING COLLECTION AND DISPOSAL AREAS.

4-44.1 Central Trash/Recycling Collection and Dumpsters.

Place central trash/recycling collection units and dumpsters 15 feet (4.6 m) or more away from wood frame or metal *Facilities* or from openings in masonry-walled *Facilities*.

4-44.2 Collection, Baling, Processing and Storage Rooms.

Rooms for collection, baling and storage must be separated from the remainder of the building by a 1-hour fire barrier and protected with automatic sprinklers.

Where the *Facility* is not protected with automatic sprinklers, the sprinkler system is permitted to be connected to the domestic water system when permitted by NFPA 13.

4-44.3 Trash/Recycling Chutes.

Provide automatic sprinklers in all trash/recycling chutes installed within a *Facility*

4-45 VEHICLE PARKING, STORAGE, MAINTENANCE, AND REPAIR FACILITIES.

4-45.1 General.

4-45.1.1 Facilities used for parking or storage of motor vehicles must comply with NFPA 88A.

4-45.1.2 Facilities used for maintenance and repair of motor vehicles must comply with NFPA 30A.

4-45.1.3 Facilities used for the fueling and dispensing of compressed natural gas (CNG) or liquefied natural gas (LNG) for vehicles or vessels must comply with NFPA 52.

4-45.2 Refueler Vehicle Facilities.

Facilities that are covered and enclosed on at least three sides and that are used for the parking, storage, maintenance, and repair of aircraft refueler vehicles must comply NFPA 30A and be provided with the following features:

4-45.2.1 Automatic sprinkler system throughout.

4-45.2.2 Class I Division 1 electrical equipment and wiring throughout the entire pit area (below floor level) in accordance with NFPA 70.

4-45.2.3 Class I Division 2 electrical equipment and wiring throughout the entire servicing area and areas not suitably cut-off in accordance with NFPA 70.

Note: This includes the area up to the underside of the roof.

4-46 WAREHOUSE AND STORAGE FACILITIES.

4-46.1 General.

4-46.1.1 Comply with UFC 4-440-01, except as modified by this UFC.

4-46.1.2 This section applies to *Facilities* (except ordnance) with a ceiling height greater than 12 feet (3.7 m) used for storage, shipping, receiving, packing, and processing of materials.

4-46.1.3 Storage of hazardous materials, including flammable or combustible liquids, must comply with this section and the requirements of the section "Hazardous Materials and Hazardous Waste" in this UFC.

4-46.2 Sprinkler Protection.

4-46.2.1 Complete automatic sprinkler protection must be provided for warehouses and storage *Facilities*, regardless of floor area or construction type.

4-46.2.1.1 Automatic sprinkler systems may be omitted for *Facilities* with an area less than 5,000 ft² (465 m²) with approval of the *DFPE*.

Note: See the “Planning” section of this UFC for guidance on determining if sprinkler protection may be omitted for smaller *Facilities*.

4-46.2.1.2 \2\The use of extended coverage control mode specific application sprinklers is permitted./2/

4-46.2.2 Sprinkler protection must include covered loading docks.

4-46.2.3 Sprinkler protection must follow the design requirements found in NFPA 13. The design density, area of application and hose stream requirements of \3\paragraph “Automatic Sprinkler Systems” in “Fire Protection Systems”/3/ chapter of this UFC do not apply to high-pile storage as defined by NFPA 13.

4-46.2.3.1 Sprinkler protection, at a minimum, must be based on Class IV, non-encapsulated commodities, as defined by NFPA 13, unless a more severe class of storage is anticipated, and must be based on the maximum potential height of storage. The maximum potential height of storage is based on the roof or ceiling height.

4-46.2.4 If provided, in-rack sprinklers must be supplied from risers that are separate from the ceiling sprinklers, except in existing facilities.

4-46.2.5 Racks with solid shelves over 12 feet (3.7 m) in height must be protected with in-rack sprinklers at every tier or shelf level.

4-46.2.6 Sprinkler riser control valves must be readily accessible to the fire department from the exterior.

4-46.2.7 Duration.

The water supply must be capable of providing the minimum duration requirements of NFPA 13 for the protection method selected.

4-46.2.8 Hose Stream Allowance.

Provide a hose stream allowance as required by NFPA 13 for the protection method selected.

4-46.2.9 Roof Slope.

Maximum roof slope must be in accordance with NFPA 13.

4-46.3 Bin Storage.

4-46.3.1 Requirements.

4-46.3.1.1 Protect in accordance with NFPA 13, except as noted below.

4-46.3.1.2 The ceiling density must be increased by 10 percent or one additional level of in-rack sprinklers where combustible bins are stored in racks.

4-46.3.1.3 Mini-storage and retrieval systems and carousel storage must be protected in accordance with FM Global Data Sheet 8-33 or FM Global Data Sheet 8-34.

4-46.4 Column Protection.

Steel columns must be protected as required by NFPA 13.

4-46.5 *Fire Areas.*

4-46.5.1 Warehouse *Fire Areas* must not exceed 60,000 ft² (5,574 m²). Warehouse *Fire Areas* may be increased to 120,000 ft² (11,148 m²) when all of the following provisions are met:

4-46.5.1.1 Ceiling sprinkler design area must be increased by 10 percent. This requirement does not apply when ESFR sprinklers are utilized.

4-46.5.1.2 Dedicated looped *service mains* must be provided with enough sectional valves to isolate each *Service Lateral* around the warehouse.

4-46.5.2 Separation of *Fire Areas*.

4-46.5.2.1 *Fire Areas* must be separated from other *Fire Areas* by 4-hour fire walls in accordance with the IBC Chapter entitled "Fire and Smoke Protection Features".

4-46.5.2.2 Other occupancies, such as offices or shops, must be separated from the warehouse and storage area by a minimum of 1-hour fire-rated construction, unless a higher rating is required by the IBC.

4-46.6 Conveyor and Mechanical Handling System Penetrations.

4-46.6.1 When mechanical handling systems such as conveyors, penetrate fire barriers, the opening must be protected by a fire door or fire shutter.

4-46.6.2 When a fire door or shutter is not feasible due to the operation of the conveyor, the *DFPE* must be consulted to determine the appropriate protection criteria.

4-47 WATERFRONT FACILITIES.

Waterfront and harbor facilities must comply with all of the following, as applicable:

- a. NFPA 303.
- b. NFPA 307.
- c. NFPA 312.
- d. UFC 4-152-01.
- e. UFC 4-150-02.
- f. UFC 4-151-10.
- g. UFC 4-213-10.
- h. UFC 4-213-12
- i. NAVSEA OP-5 (for Navy/Marines only).

4-48 WILDLAND-URBAN INTERFACE LOCATIONS.

4-48.1 General.

As required by Executive Order 13728, facilities within the wildland-urban interface must follow the requirements of the International Wildland-Urban Interface Code./3/

This Page Intentionally Left Blank.

CHAPTER 5 GENERAL BUILDING HEIGHTS AND AREAS

5-1 GENERAL.

Allowances or exceptions that require the *Facility* to be protected throughout by an approved automatic sprinkler system may only be applied where the system is an approved, electrically supervised automatic sprinkler system as described in NFPA 101. References to IBC Section 903.3.1.1 are replaced with NFPA 13. References to IBC Section 903.3.1.2 are replaced with NFPA 13R.

5-2 BUILDING HEIGHT LIMITATIONS.

Conform to the requirements of IBC Chapter 5.

5-3 BUILDING AREA LIMITATIONS.

Conform to the requirements of IBC Chapter 5.

Note: IBC Chapter 5 does not permit area increases for sprinkler systems if the sprinkler system is designed per NFPA 13R.

5-4 OCCUPANCY SEPARATION.

5-4.1 General.

5-4.1.1 Occupancy separation must comply with the IBC Chapter 5. Do not use NFPA 101 for occupancy separation requirements, except as noted below.

5-4.1.2 NFPA 101 must be utilized for occupancy separations of medical funded projects, healthcare, ambulatory healthcare and all facilities required to comply with The Joint Commission standards.

5-4.1.3 \3\For the location of an occupancy within a facility, see paragraph "NFPA 101" in Chapter "Use and Occupancy Classification" of this UFC./3/

5-5 INCIDENTAL USE.

NFPA 101 must be utilized for protection from hazards. IBC requirements for separation of incidental uses are not permitted.

This Page Intentionally Left Blank

CHAPTER 6 TYPES OF CONSTRUCTION

6-1 GENERAL.

Conform to the requirements of IBC Chapter 6, except as modified by this UFC.

6-2 SEPARATION BETWEEN BUILDINGS.

Conform to the requirements of the IBC, except as modified by this UFC.

This Page Intentionally Left Blank

CHAPTER 7 FIRE AND SMOKE PROTECTION FEATURES

7-1 GENERAL.

Conform to the requirements of NFPA 101 except as noted below.

Where IBC Chapter 5 or 6 specifically references IBC Chapter 7, utilize the specific IBC Chapter 7 reference.

Note: For example, IBC Section 508.4.4.1 specifically references IBC Sections 707 and 711. When utilizing IBC Section 508.4.4.1, utilize IBC Sections 707 and 711, otherwise IBC Sections 707 and 711 are not to be used unless specifically referenced.

7-2 MARKING AND IDENTIFICATION.

Conform to the requirements of the IBC for marking and identification of fire walls, fire barriers, fire partitions, smoke barriers, smoke partitions or any other wall required to have protected openings.

For Navy, Marines, and NRO, stenciling must be provided and spaced no more than 10 foot, measured edge to edge horizontally along the wall or partition.

7-3 NON-LOAD BEARING PARTITIONS AND BARRIERS.

Comply with NFPA 101 for fire resistance ratings of non-load bearing partitions and barriers, except occupancy separation as indicated in Chapter 5.

7-4 PROTECTION OF STRUCTURAL MEMBERS.

7-4.1 General.

Comply with IBC Chapter 7 for protection of structural members, except as noted below.

7-4.2 Sprayed Fire-Resistant Materials.

7-4.2.1 Sprayed fire-resistant materials must be medium or high density cementitious or an intumescent thin-film coating.

Note: Intumescent thin-film coating is not the same material as intumescent paint.

7-4.2.2 Mineral fiber or low-density cementitious materials are not permitted.

7-4.2.3 Provide UL-listed floor/ceiling and UL-listed roof/ceiling assemblies that do not require the underside of the roof or floor deck to have spray-applied fireproofing. The assembly must be designed so only columns, beams, and trusses receive spray-applied fireproofing to achieve the rating for the assembly.

7-4.3 Ceilings.

Listed floor/ceiling or roof/ceiling assemblies that utilize suspended gypsum wallboard or acoustical tile ceilings must not be used to achieve required fire resistance rating of building structural elements.

7-5 SMOKE AND HEAT VENTS.

7-5.1 General.

7-5.1.1 Smoke and heat vents must not be provided unless specifically required by this UFC.

Note: Smoke and heat vents should be considered in *Facilities* where a high rate of heat release is anticipated during a fire such as indoor firing ranges with rubber impact zones.

7-5.1.2 Where provided in *Facilities* without automatic sprinklers, smoke and heat vents must be arranged to operate automatically in accordance with NFPA 204.

7-5.1.3 Where provided in *Facilities* with automatic sprinkler protection, smoke and heat vents must be arranged to operate in the manual mode only.

Note: Skylights can be used as a method of providing manual smoke and heat vents.

7-6 HIGH VOLUME LOW SPEED (HVLS) FANS.

Comply with NFPA 13, except all HVLS fans must be interlocked to shut down immediately upon any fire alarm activation.

7-7 PLASTIC PIPE AND CONDUIT.

7-7.1 Penetrations.

Penetrations by plastic pipe or conduit through fire-rated walls, partitions, shafts, and floors must be fire stopped by an approved or listed method in accordance with ASTM E814 or UL 1479.

7-7.2 Prohibited Locations.

Plastic pipe and conduit must not be installed in exit stair enclosures, or in air plenum spaces, unless specifically listed for that application.

CHAPTER 8 INTERIOR FINISHES

8-1 GENERAL.

Conform to the requirements of NFPA 101.

8-2 DROP-OUT PANELS.

Drop-out panels, as defined in NFPA 13, must not be used.

8-3 INSULATION.

8-3.1 Requirements.

8-3.1.1 Use thermal and acoustical insulation with a flame spread (FS) rating not higher than 75, and a smoke developed (SD) rating not higher than 150 when tested in accordance with ASTM E84 (NFPA 255).

8-3.1.2 Exposed insulation in concealed spaces of sprinkled buildings must be specified to have a flame spread of 25 or less and a smoke developed rating of 50 or less (including $\sqrt{2}$ /covering).

Note 1: This is to prevent the space from being defined as a combustible concealed space, which would require sprinkler protection in accordance with NFPA 13.

Note 2: Acceptable types of insulation blankets per Federal Spec HH-521F are Type I, Type II (Class A only), and Type III (Class A only).

8-3.2 Exceptions to Insulation Criteria.

For certain types of insulation installation, the exceptions described in paragraphs entitled "Flame Spread – No Smoke Developed Rating Limitation" and "No Flame Spread or Smoke Limitation" below will apply.

8-3.2.1 Flame Spread - No Smoke Developed Rating Limitation.

Compliance with the SD rating limitation is not required, and a FS rating up to 100 is permitted for insulation, including insulating sheathing installed within wall assemblies. In such installations, conform to the requirements for interior finish with a minimum fire resistance rating of 15 minutes when tested in accordance with ASTM E119.

8-3.2.2 No Flame Spread or Smoke Limitation.

Compliance with FS and SD limitations are not required for the following applications:

- a. Insulation installed above poured concrete or poured gypsum roof decks, nominal 2-in. (50.8 mm) thick tongue-and-groove wood plank roof decks, or precast roof deck panels or planks that are approved by a Nationally

Recognized Testing Laboratory (NRTL), as noncombustible roof deck construction.

- b. Insulation installed above roof decks where the entire roof construction assembly, including the insulation, is UL-listed as Fire Classified, or FM-approved for Class I roof deck construction or equal listing or classification by a NRTL.
- c. Insulation contained entirely within panels where the entire panel assembly used in the construction application meets the cited FS and SD limitations.
- d. Insulation isolated from the interior of the building by masonry walls, masonry cavity walls, insulation encased in masonry cores, or concrete floors.
- e. Insulation installed over concrete floor slabs and completely covered by wood tongue-and-groove flooring without creating air spaces within the flooring system.
- f. Insulation completely enclosed in hollow metal doors.
- g. Insulation installed between new exterior siding materials and existing exterior siding or wood board, plywood, fiberboard, or gypsum exterior wall sheathing.

Note: The exception to SD limitations described in this paragraph is not applicable to correctional facilities.

CHAPTER 9 FIRE PROTECTION SYSTEMS

9-1 FIRE DEPARTMENT (EMERGENCY) VEHICLE ACCESS.

9-1.1 All-Weather Ground Access.

All *Facilities* greater than 5,000 ft² (465 m²), or more than two stories in height, must have at least one means of all-weather ground access to allow emergency vehicles unimpeded access to the *Facility*. All-weather ground access must be paved, start from the road, and terminate no farther than 33 feet (10 m) from an exterior door accessible for fire department ingress (i.e. a stair door or some other exterior door that provides access to the *Facility* interior). The route between the access surface and exterior door must be able to be traversed without the use of a ladder.

An engineered all-weather surface that is not paved may be provided if approved by the *DFPE*.

9-1.2 Aerial Apparatus Access.

New facilities four stories or more in height and all new warehouses must be provided with suitable all-weather ground access for aerial apparatus on a minimum of two sides of the perimeter of the structure. The access must be parallel to at least one entire side of the *Facility* with windows to allow aerial access to the entire side. The distance between the aerial apparatus access and the *Facility* must be based on the responding aerial apparatus and *Facility* height and be approved by the *DFPE*.

Note: The intent of this paragraph is to provide aerial apparatus access to two sides of the building, with one side having access along the entire side of the building so that the aerial apparatus has multiple locations to set up operations. Aerial apparatus access must be coordinated with fire department ingress noted above.

9-1.3 Vehicle Access.

All force protection equipment, such as bollards or gates, must not require more than one person to remove or open. Access may require fire apparatus to drive over a curb. Any locking device controlling vehicle access must be under control of the fire department or 24-hour security personnel located at the specific *Facility*. Dimensions of fire lanes and turnarounds must comply with NFPA 1. Vehicle access must be coordinated with the *Installation* or responding fire department.

9-1.4 Fire Department Connection.

Facilities with fire department connections for fire suppression systems must be provided with suitable all-weather ground access surface for any apparatus within 150 feet (45 m) of such fire department connections.

9-2 FIRE FLOW FOR FACILITIES.

9-2.1 Sprinklered *Facilities*.

Provide *Fire Flow* for sprinklered *Facilities* in accordance with NFPA 1 or 1,000 gpm at 20 psi (3,785 L/min at 138 kPa), whichever is greater. Where the *Fire Flow* cannot be met, the *DFPE* is permitted to approve a reduction in *Fire Flow*. *Fire Flow* is calculated independently of the *Fire Water Demand*.

9-2.2 Non-sprinklered *Facilities*.

Fire Flow must be in accordance with NFPA 1, except the following special *Facilities*.

9-2.2.1 Ship Berthing and Drydock *Facilities*.

Refer to the paragraph entitled "Waterfront *Facilities*" for *Fire Flow* requirements for ship berthing and drydock facilities.

9-2.2.2 Aircraft Parking and Refueling *Facilities*.

A minimum *Fire Flow* of 1,000 gpm (3,785 L/min) for a 2-hour duration is to be provided for all such *Facilities*.

9-2.2.3 Yard and Outdoor Storage.

9-2.2.3.1 Yard and outdoor storage must comply with the requirements of NFPA 80A, and FM Global Data Sheet 1-20.

9-2.2.3.2 Aisle widths and separation distances must be maintained to limit the exposure to nearby *Facilities* and to facilitate manual firefighting operations.

9-2.2.4 Vehicle Parking Areas.

A minimum *Fire Flow* of 500 gpm (1900 L/m) for a 2-hour duration must be provided for all such areas.

9-2.3 Family Housing.

The *Fire Flow* for family housing must be as follows:

- a. One-story - 500 gpm (1,900 L/min) for 90 minutes.
- b. Two-story - 750 gpm (2,840 L/min) for 90 minutes.
- c. Three-story and above - 1,000 gpm (3,785 L/min) for 90 minutes.

9-3 *SERVICE MAINS AND LATERALS.*

9-3.1 General.

9-3.1.1 *Service Mains and Service Laterals* must comply with AWWA M31, NFPA 24 and UFC 3-230-01, except where specifically modified by this UFC.

9-3.1.2 $\sqrt{2}$ For service laterals that do not utilize PVC pipe, the velocity must not exceed 10 feet per second (3 m/s)./2/

9-3.1.3 This section applies to both dedicated (fire only) and combined (domestic and fire) water distribution systems.

9-3.1.4 For *Service Mains* served by fire pumps or *Service Laterals* serving fire pumps, velocities must be calculated using 150 percent of the rated capacity of the fire pump.

9-3.1.5 Provide appropriate corrosion protection based on pipe material and corrosive properties of the water supply and earth.

9-3.1.6 Where cathodic protection is indicated based upon present conditions, comply with the following: For the Army, comply with UFC 3-570-02A, for the Navy and Marines, comply with UFC 3-570-02N, and for Air Force, comply with AFI 32-1054 and UFC 3-570-06.

9-3.2 *Service Mains.*

9-3.2.1 *Service Mains* must be sized to accommodate *Fire Flow* plus domestic and industrial demands that cannot be restricted during fires.

9-3.2.2 *Service Mains* must be looped to provide at least 50 percent of the required *Fire Flow* in case of a single break.

9-3.2.3 *Service Mains* must not be dead-end.

9-3.2.4 *Service Mains* must be sized so that the minimum residual pressure available, at 150 percent of a *Facility* fire pump rating, if provided, is not less than 20 psi.

9-3.3 *Service Laterals.*

9-3.3.1 Not more than two fire hydrants can be located on a *Service Lateral*.

9-3.3.2 Minimum size *Service Lateral* for fire sprinkler systems must be not less than 6-in. (150 mm) in diameter.

9-3.3.2.1 For NFPA 13R systems, the *Service Lateral* is permitted to be 4-in. (100 mm) if supported by hydraulic calculations.

9-3.3.2.2 For NFPA 13D systems, the minimum *Service Lateral* size must be based on hydraulic calculations.

9-3.3.3 The minimum residual pressure in a *Service Lateral* must not be less than 20 psi at the greater of *Fire Flow* or *Fire Water Demand*. This residual pressure must be maintained at the inlet of the backflow preventer or suction side of the fire pump, whichever is closer to the *Service Main*.

9-3.3.4 A *Service Lateral* supplying a fire pump must be able to support 150 percent of the fire pump rated capacity without falling below the required net positive suction head (NPSH) at the suction side of the pump. Where NPSH cannot be met at 150 percent of the fire pump rated capacity, the *DFPE* is permitted to reduce the required flow at NPSH, but in no case is it permitted to be less than the required fire suppression system demand.

Note: Piping downstream of the fire pump is not a *Service Lateral*. Piping downstream of the fire pump must be sized based on the *Fire Water Demand* of the *Facility* or the minimum required by NFPA 20, whichever is greater, not 150 percent of the fire pump rated capacity.

9-3.4 Valves.

9-3.4.1 Control valves must be provided in each source of water supply, such as tanks and pumps.

9-3.4.2 A control valve must be provided on the *Service Lateral* downstream of the connection to the *Service Main*.

9-3.4.3 A sufficient number of sectional valves must be provided on the *Service Main*, so that not more than a combined total of five hydrants or the *Service Laterals* to not more than three separate buildings are out of service due to a single break.

9-3.4.4 Sectional valves on *Service Mains* may be key-operated type. New valves must open by counter-clockwise rotation of the stem.

9-3.4.5 Supervision.

When provided, PIV's must be supervised using a lock or tamper seal, at a minimum.

9-3.5 Fire Hydrants.

9-3.5.1 Fire hydrants must be UL-listed, FM-approved, or listed or classified by an NRTL and must have two 2 1/2-in. (65 mm) hose outlets and one 4 1/2-in. (115mm) outlet with national standard fire hose threads in accordance with NFPA 1963.

Comply with the *Installation* fire department or local responding fire department when they require a different arrangement or hose threads.

9-3.5.2 Wet barrel or California-type hydrants are preferable in areas where there is no danger of freezing. Dry barrel or traffic-type hydrants must be used in areas where there is a danger of freezing. Hydrants must be aboveground type and match the type used on the *Installation*.

9-3.5.3 In DoD *Installations* serviced by only local fire departments, hydrant hose threads must meet local requirements.

9-3.5.4 See AWWA Manual M 17 and AWWA Manual M 31 for additional information.

Note: Overseas *Installations* with current below grade hydrants in accordance with local national policy are acceptable.

9-3.5.5 \1V1/Hydrant caps/barrels must be color coded to prevent cross-connection. In the absence of an *Installation* established color code standard, the following colors must be used; red for non-potable water, yellow for potable water, and purple for reclaimed/reuse water. All hydrants must also be marked based on the *Fire Flow* capacity, in accordance with NFPA 291 or by the *Installation* established marking standard

9-3.5.6 Clearly mark each new hydrant with an identification number assigned by the *Installation*.

9-3.5.7 Construction Requirements.

- a. Installation must be in accordance with NFPA 24 except as modified by this UFC.
- b. Hydrants must be installed adjacent to paved areas, accessible to fire department apparatus.
- c. *Service Lateral* supplying hydrants must be minimum 6-in. (150 mm) and valved at the connection to the *Service Main*.
- d. Barrels must be long enough to permit at least 18-in. (450 mm) clearance between the center of the 4 1/2-in. (115 mm) outlet and grade.
- e. The ground must be graded so that any surface drainage is away from the hydrant.
- f. The 4 1/2-in. (115 mm) outlet must be perpendicular to the street to allow straight connection to the pumper.
- g. Landscaping, fencing, bollards and similar must be located a minimum of 24-in. (610 mm) from the \4\vertical/4/ centerline of the hydrant and not directly in front of any outlet.
- h. For fire hydrants adjacent to airfield pavement, \2\the tops of the fire hydrants should not be installed more than 24 inches (610 mm) above the level of the adjacent airfield pavement but in no case must the tops of the

fire hydrants be installed higher than 30 inches (760 mm) above the airfield pavement./2/

9-3.5.8 Spacing Requirements.

9-3.5.8.1 A sufficient number of hydrants must be provided so that *Fire Flow* can be met without taking more than 1,250 gpm (4,740 L/min) from any single hydrant.

9-3.5.8.2 All parts of the *Facility* exterior must be within 350 feet (106 m) of a hydrant with consideration given to accessibility and obstructions.

9-3.5.8.3 Hydrants must be located with consideration given to emergency vehicle access.

9-3.5.8.4 Hydrants must be spaced in accordance with the following requirements:

- a. At least one hydrant must be located within 150 feet (45 m) of the fire department connection.
- b. Hydrants protecting warehouses must be spaced \2\along the sides of the *Facility* with fire department access/2/ at 300 feet (91 m) maximum intervals.
- c. Exterior storage and military/tactical equipment/vehicle parking must be provided with hydrants spaced at 300 feet (91 m) maximum intervals around the perimeter.

Note: Military/tactical equipment/vehicle parking applies to large parking areas typically found at reserve facilities or similar locations. This does not apply to small parking areas.

- d. Hydrant spacing must be spaced at 600 feet (182 m) maximum intervals for non-sprinklered family housing.
- e. Hydrant spacing must not exceed 1,000 feet (305 m) in areas where all family housing is provided with sprinkler protection.
- f. \2\ Fire hydrants protecting aircraft parking and servicing aprons must be spaced at 300 feet (91 m) maximum intervals along one side./2/

9-3.5.9 Protection.

Hydrants located adjacent to parking areas, vehicle traffic areas or other areas subject to mechanical damage, must be protected by bollards. The bollards must be located so they are not directly in front of an outlet. The bollards must allow clearance to attach hoses, allow for the removal of the hydrant caps, and for the hydrant to be opened and closed without obstructions. Refer to UFC 3-260-01 where bollards are required for hydrants located adjacent to aircraft parking and servicing aprons.

9-3.6 Pressure-Regulating Valves (PRVs).

PRVs must not be provided on *Distribution Mains, Service Mains* or *Service Laterals*.

9-4 FACILITY ON-SITE WATER STORAGE.

9-4.1 General.

9-4.1.1 On-site fire protection water storage must comply with NFPA 22, except where specifically modified by this UFC.

9-4.1.2 The discharge or suction line(s) from each individual tank or reservoir section must be sized to deliver the maximum required flow.

9-4.2 Quantity.

9-4.2.1 The total usable supply stored must be equal to 120% of the Facility's maximum required *Fire Water Demand* for the applicable duration specified in this UFC plus any applicable domestic or industrial demand.

9-4.2.2 In calculating the fire protection water storage requirement, a reduction in storage capacity is acceptable if an adequate replenishment source is available. Factors that must be evaluated include the reliability of the makeup supply, its sustained flow capacity, its method of operation (automatic or manual), and flow limitations imposed by the capacity of treatment operations.

9-4.3 Replenishment of Storage.

The water storage must be capable of being self-replenished to its required volume within 48 hours, during normal domestic and industrial consumption of the supplying utility.

9-4.4 Monitoring.

9-4.4.1 The water level must be remotely monitored in accordance with NFPA 22 and NFPA 72 by the *Installation Fire Alarm Reporting System*.

9-4.4.2 In locales subject to freezing, water temperature of aboveground storage tanks must likewise be monitored by the *Installation Fire Alarm Reporting System*.

9-5 FIRE PUMPS.

9-5.1 General.

9-5.1.1 Fire pumps must comply with NFPA 20, except where specifically modified by this UFC.

9-5.1.2 Fire pumps must be located in a detached, noncombustible pump house or located in a fire-rated room in accordance with NFPA 20 with direct access from the exterior.

9-5.1.3 Maintenance access must be provided to the pump and driver so that either can be removed from the fire pump room. Access is permitted to be via double doors or overhead door directly to the exterior. This is in addition to the normal means of egress required by NFPA 101.

9-5.1.4 Provide a minimum of 3 feet (915 mm) of clearance on one side of the fire pump assembly for maintenance and in front of the pump controller or the minimum required by NFPA 70. A clear width of 3 feet must be provided from the room entry to the fire pump assembly and controller.

9-5.1.5 Provide a minimum of 3 feet (915 mm) access to and in front of all equipment and 6-in. (150 mm) behind the equipment, (e.g., control valves, check valves, etc.).

9-5.1.6 Provide labeling on the surfaces of the piping in the pump room to show the water flow direction and pipe function (e.g., "Suction", "Discharge", "To Fire Dept. Connection", "To Bypass", "To Test Header", "To Standpipe", "To Sprinkler System"). Provide white painted stenciled letters and arrows, a minimum of 2-in. (50 mm) in height and visible from at least three sides when viewed from the floor.

9-5.1.7 The maximum fire suppression system demand must not exceed 140 percent of rated pump capacity. The pressure at the inlet of the pump at 150 percent of the rated pump capacity must not be less than the required net positive suction head in accordance with NFPA 20. Where NPSH cannot be met at 150 percent of the fire pump rated capacity, the *DFPE* is permitted to reduce the required flow at NPSH, but in no case is it permitted to be less than the required fire suppression system demand.

9-5.1.8 Terminate all drainage piping and test piping from the fire pump or associated appurtenances (e.g., circulation relief valve, bowl drains, etc.), including backflow preventers, to a floor drain or to the exterior of the *Facility* so it will not cause damage.

9-5.1.8.1 Provide concrete pads or splash blocks where discharge location is to other than a concrete slab. Splash blocks must be large enough to mitigate erosion and must not become dislodged during a full flow of the drain. Ensure all discharged water drains away from the *Facility* and does not cause property damage

9-5.1.8.2 Discharge to the exterior must not interfere with exiting from the *Facility*. Water discharge must not cross an exit or exit discharge.

9-5.1.8.3 Drainage piping of less than 3/4-in. (20 mm) may discharge to a floor drain.

9-5.1.9 Full flow relief valve piping must discharge safely in accordance with NFPA 20. If an on-site water storage tank or reservoir is provided, the piping must discharge back to the tank or reservoir.

9-5.1.10 \2\For DLA, a reserve fire pump of the same size must be provided when the total value at risk is greater than \$100 million./2/

9-5.2 Pump Type.

A fire pump may be either a horizontal or vertical centrifugal pump, or a vertical turbine pump; whichever is most economical and appropriate for the intended use.

9-5.3 Pump Start and Shutdown.

9-5.3.1 Fire pumps must be arranged to start automatically.

9-5.3.2 Fire pumps must be arranged to automatically shut down after reaching the stop pressure and the expiration of \3\the minimum run time determined by NFPA 20/3/. Stop pressure must be at least 5 psi below maximum churn pressure at the lowest available static pressure.

Note: The lowest available static pressure should be utilized in determining churn pressure so that the stop pressure can be achieved with low pressure. The 5 psi differential is used to allow for gauge error.\2\

9-5.3.3 /2\Fire pump activation (run) must transmit an alarm condition to the *Installation* receiving station, or remote receiving station, but not activate the *Facility* notification appliance circuits (i.e. no audible/visual notification in the protected *Facility(s)*).

9-5.4 Pump Drive.

9-5.4.1 Electric power must comply with NFPA 20. Where electric power is available from a *Reliable Power Source* of adequate capacity, electric motor driven fire pumps must be used.

9-5.4.2 When a *Reliable Power Source* is not available, electric motor driven fire pumps must be provided with a secondary power source (i.e. emergency generator with automatic transfer switch). See Chapter 2 for the definition of *Reliable Power Source*.

9-5.4.3 A diesel engine driven fire pump is permitted in lieu of an electric motor driven fire pump when a *Reliable Power Source* is not available.

Note: Air Force preference is to utilize electric motor driven fire pump(s) with a secondary power source when a *Reliable Power Source* is not available.

9-5.4.4 Diesel engine driven fire pumps must not be arranged to start automatically upon loss of normal power.

9-5.5 Controllers.

9-5.5.1 Soft start, reduced voltage controllers are required for electric motor driven fire pumps equal to or greater than 100 hp or when the fire pump is connected to an emergency generator.

9-5.5.2 Any starting method permitted by NFPA 20 is acceptable for electric motor driven fire pumps less than 100 hp and not connected to an emergency generator/2/ must comply with UFC 3-520-01.

9-5.5.3 Limited service controllers are permitted when approved by a NRTL and NFPA 20.

9-5.5.4 Variable speed controllers are permitted when approved by a NRTL.

9-5.6 Pump Bypass.

Provide a bypass in accordance with NFPA 20 around all fire pumps that take suction from a *Service Lateral*.

9-5.7 Electric Circuits for Diesel Engine Driven Pumps.

Provide separate hard-wired electric circuits for the pump controller, engine starting system battery charger and hard-wired electric circuit for the engine block heater.

9-5.8 Test Connections.

9-5.8.1 Provide a test header manifold on the *Facility* exterior that permits flow testing directly from the header. Coordinate the location of test header with other disciplines to ensure flow from test header does not discharge onto other equipment or cause property damage.

9-5.8.2 Provide a flow meter installed in accordance with NFPA 20.

9-5.8.2.1 The flow meter must be installed in series with the test header unless it is piped to discharge into a water storage tank or reservoir.

9-5.8.2.2 Where a water storage tank or reservoir provides suction to the fire pump, the flow meter discharge must be piped back to a water storage tank or reservoir.

9-6 **FIRE SUPPRESSION SYSTEMS.**

9-6.1 General.

9-6.1.1 This section applies to all fire suppression/extinguishing systems including, but not limited to: automatic sprinkler systems; water spray systems; foam systems; standpipe systems; dry chemical extinguishing systems; wet chemical extinguishing

systems; clean agent fire extinguishing systems; water mist fire protection systems; carbon dioxide systems; and, halon 1301 systems.

9-6.1.2 Fire suppression systems must be designed and installed in accordance with the applicable NFPA standard, except where specifically modified by this UFC.

9-6.2 Connections to *Fire Alarm Reporting Systems*.

9-6.2.1 Where fire suppression systems are installed in or at *Facilities on Installations with Fire Alarm Reporting Systems*, the fire suppression systems must be connected to the *Fire Alarm Reporting System* for transmission of alarms, supervisory and trouble signals. \3\NFPA 13D systems are not required to be connected to the *Fire Alarm Reporting System*./3/

9-6.2.2 Where installed in areas without an *Installation Fire Alarm Reporting System*, the fire suppression system must be connected to a remote supervising station for alarm, supervisory and trouble signals.

9-6.3 Plans and Calculations.

9-6.3.1 All working (shop) drawings, regardless of the type of fire suppression system, must meet the drawing requirements in NFPA 13 for Working Drawings, unless the system specific standard has requirements for working drawings.

9-6.3.2 For new or modified systems, working (shop) drawings and calculations must be prepared by an individual that has obtained National Institute for Certification in Engineering Technologies, Automatic Sprinkler Systems, Level III certification or Special Hazards Suppression Systems, Level IV certification, as applicable to the project. The *QFPE* must review the shop drawings, hydraulic calculations and material submittals. The shop drawings must bear the *Review Stamp* of the *QFPE* prior to submitting the fire extinguishing system shop drawings to the *DFPE*.

For Army projects, construction (shop) drawings and calculations must be prepared by, or prepared under the immediate supervision of, the *QFPE*. The *QFPE* must affix their professional engineering stamp with signature to the shop drawings, calculations and material data sheets, indicating approval prior to submitting the fire extinguishing system shop drawings to the *DFPE*. The *QFPE* must monitor the installation of the fire protection systems and certify in writing that the fire protection systems have been constructed and operate as intended in the design plans and specifications.

9-6.3.3 When 20 or less sprinklers are modified or relocated, shop drawings, hydraulic calculations and material submittals are not required to be submitted.

9-6.3.4 The preparer of the shop drawings must perform calculations (i.e. hydraulic calculations, agent flow calculations) in accordance with the applicable NFPA standard, demonstrating that the design will provide an adequate supply for the fire suppression systems. Calculations must be submitted no later than the first shop drawing submission.

9-6.3.5 Hydraulic calculations must include a minimum pressure drop across backflow preventers. For a reduced pressure backflow preventer, use a minimum of 12 psi (82.7 kPa). For a double check backflow preventer, use a minimum of 8 psi (55.2 kPa).

9-6.3.6 When nitrogen is utilized in dry or preaction sprinkler systems, a C-factor of 120 is permitted to be used in hydraulic calculations.

9-6.3.7 The dimension from the edge of standpipes and fire suppression system risers to the nearest adjacent wall(s) must be indicated on the drawings when located in stairs or other portions of the means of egress.

9-6.3.8 The *QFPE* must consult with the *DFPE* or *Installation* fire safety agency to clarify location of fire department connection(s) or type of hose threads.

Note: The *Installation* fire safety agency will typically be the fire department.

9-6.4 Waterflow Testing.

Conduct waterflow tests, in accordance with the procedures contained in NFPA 291 to determine available water supply for the water-based fire extinguishing systems. The flow test must be performed under the direction of the *QFPE*.

Note: Hydraulic calculations should be based on a waterflow test that was performed no more than 6 months prior to submission of the calculations.

9-6.5 *Fire Water Demand.*

Domestic demand and hose stream are not required to be included in the *Fire Water Demand* when supplied from a utility or source separate from that supplied to the fire suppression system (i.e. tank for fire, water main for hydrant or domestic). Domestic or industrial demands are not included in the *Fire Water Demand* where means are provided to restrict these demands during a fire incident.

9-6.6 Backflow Prevention and Cross Connection Control.

The installation of backflow prevention and cross connection control must comply with AWWA Manual M 14.

9-6.6.1 Potable Water Supply.

For new fire suppression systems using water only, follow the *Installation* requirements for proper type of backflow prevention.

9-6.6.2 Installation.

9-6.6.2.1 Install a reduced pressure type backflow prevention device where antifreeze, foam or other chemicals are added into the system.

9-6.6.2.2 For locations subject to freezing, backflow preventers must be located in the *Facility* or within a heated enclosure. Provide a low temperature supervisory alarm connected to the *Facility* FACP for heated enclosures. Heat trace must not be used unless a heated enclosure cannot be provided.

9-6.6.2.3 Install horizontal backflow preventers so that the bottom of the assembly is no greater than 24-in. (610 mm) above the finished floor/grade. Install vertical backflow preventers so that the upper operating handwheel is no more than 6 feet (1.8 m) above the finished floor/grade.

9-6.6.3 Prior to the installation of backflow preventers in an existing fire suppression system, a thorough hydraulic analysis, including hydraulic calculations and flow test, must be performed to ensure that the water supply is still adequate for the system with the backflow preventer. If the backflow preventer causes the demand to exceed the water supply, the backflow preventer must not be installed until the water supply is corrected to support the new demand.

9-6.6.4 When installed as part of a fire pump system, piping and fittings suitable for potable water must be used upstream of the backflow preventer in accordance with local environmental requirements. The backflow preventer must be located where required by NFPA 20 unless the local environmental requirements differ.

9-6.6.5 Test Header.

9-6.6.5.1 All new water-based fire suppression systems must have test valves installed downstream of the backflow preventer. These valves must be angle or globe valves with 2.5-inch male National Standard Hose Threads with cap and chain. Provide one valve for each 250 gpm, and fraction thereof, of system design flow (e.g., a volumetric waterflow rate of 450 gpm would require two valves).

9-6.7 Meters.

Where meters are installed on a *Service Lateral* serving fire suppression systems, hydrants, or standpipe systems, they must be listed by a NRTL as fire service meters.

9-6.8 Painting and Labeling.

9-6.8.1 Labeling must be in accordance with MIL-STD-101, except as modified by this section.

9-6.8.2 Provide labeling on the surfaces of all feed and cross mains to show the pipe function (e.g., "Sprinkler System", "Fire Department Connection", "Standpipe").
For pipe sizes 4-inch and larger (100 mm), provide white painted stenciled letters and arrows, a minimum of 2-in. (50 mm) in height and visible from at least two sides when viewed from the floor.
For pipe sizes less than 4-inch (100 mm), provide white painted stenciled letters and arrows, a minimum of 0.75-in. (18 mm) in height and visible from the floor.

9-6.8.3 All fire suppression system valves must be marked with permanent tags indicating normally open or normally closed.

9-7 AUTOMATIC SPRINKLER SYSTEMS.

9-7.1 General.

9-7.1.1 Automatic sprinkler systems must comply with NFPA 13, except where specifically modified by this UFC.

9-7.1.2 When automatic sprinkler protection is required by this UFC, it is meant that a wet pipe sprinkler system is to be provided, unless environmental concerns indicate otherwise (e.g., freezing conditions).

9-7.1.3 Sprinkler systems must use equipment and devices listed by a NRTL.

9-7.2 Application Requirements.

9-7.2.1 Complete automatic sprinkler protection must be provided \5\ where required by other codes or standards and for the following/5/:

9-7.2.1.1 Single-story, Type I or II construction *Facilities* greater than 15,000 ft² (1,394 m²) gross floor area

9-7.2.1.2 Multi-story *Facilities*, regardless of floor area or construction type.

9-7.2.1.3 Single-story, Type III, IV and V construction greater than 5,000 ft² (465 m²)

9-7.2.1.4 As specified by other sections of this UFC.

9-7.2.1.5 As required by the IBC for area, height or construction type modifications.

9-7.2.1.6 \2\ See the paragraph entitled "Automatic Sprinkler Systems" in the "Planning (Contract Document Development)" section of the "Introduction" Chapter in this UFC./2/

9-7.2.2 The requirement for automatic sprinkler protection for tension fabric structures must be determined by the DFPE

9-7.2.3 New or modified automatic sprinkler protection for existing *Facilities* must comply with the requirements of the "Existing Facilities" chapter of this UFC.

9-7.2.4 Sprinkler protection must be provided for additions \5\ to a *Facility* or Modifications, as defined by NFPA 101, /5/ of existing *Facilities* if the entire gross floor area of the *Facility* (including the addition, if provided) exceeds the area limitations noted above \2\or is multistory/2/.

9-7.2.4.1 \3\2\The addition or portion of the building being modified must include sprinkler protection and be designed to support /3/sprinklers for the remainder of the *Facility*/2/.

9-7.3 Design Requirements.

9-7.3.1 *Facilities* requiring sprinkler protection must be provided with sprinkler systems that are designed using the Area/Density Method of NFPA 13, except the discharge requirements for non-storage occupancies must be in accordance with Table 9-3, unless otherwise specified in this UFC.

Note: Common DoD hazard classifications that are not noted in NFPA 13 can be found in Appendix B.

9-7.3.1.1 Residential occupancies must comply with the residential design criteria in NFPA 13, NFPA 13R or NFPA 13D, as applicable.\2\

9-7.3.1.2 /2/Storage occupancies, in mixed use *Facilities*, must follow the miscellaneous storage and storage provisions of NFPA 13.

9-7.3.2 Wet pipe, single-interlock preaction, and non-interlock preaction sprinkler systems must use the requirements for “wet” listed in Tables 9-3 and 9-4. Dry pipe, double-interlock preaction and deluge systems must use the requirements for “dry” listed in Tables 9-3 and 9-4.

9-7.3.3 Where NFPA 13 uses the term ordinary hazard group 1 or ordinary hazard group 2, the density, k-factor, hose stream and duration must be in accordance with the ordinary hazard classification listed in Tables 9-3 and 9-4.

9-7.3.4 Where NFPA 13 uses the term extra hazard group 1 or extra hazard group 2, the density, k-factor, hose stream and duration must be in accordance with the extra hazard classification listed in Tables 9-3 and 9-4.

Table 9-3 Sprinkler Design Demand and Minimum K-Factor

Hazard Classification		(gpm/ft ²)/ft ² (mm/min)/m ² [minimum K factor]							
		Ceiling Height up to 30 ft (9.1 m)		Ceiling Height >30-45 ft (9.1 m - 13.7 m)		Ceiling Height >45-60 ft (13.7 m - 18.3 m)		Ceiling Height >60 - 100 ft (18.3 m - 30.5 m)	
		Wet	Dry	Wet	Dry	Wet	Dry	Wet	Dry
Light	Design	0.1/1500 (4/140)	0.1/1500 (4/140)	0.2/2500 (8/230)	0.2/3500 (8/330)	0.2/2500 (8/230)	0.2/3500 (8/330)	12 @ 7 psi	NA
	K-factor	5.6 (80)	5.6 (80)	11.2 (160)	11.2 (160)	11.2 (160)	11.2 (160)	25.2 (360)	NA
Ordinary	Design	0.2/2500 (8/230)	0.2/3500 (8/330)	0.2/2500 (8/230)	0.2/3500 (8/330)	0.2/2500 (8/230)	0.2/3500 (8/330)	12 @ 7 psi	NA
	K-factor	8.0 (115)	8.0 (115)	11.2 (160)	11.2 (160)	11.2 (160)	11.2 (160)	25.2 (360)	NA
Extra	Design	0.3/2500 (12/230)	0.3/3500 (12/330)	0.3/3600 (12/340)	0.3/4600 (12/430)	0.5/3000 (20/280)	0.5/4000 (20/370)	12 @ 7 psi	NA
	K-factor	11.2 (160)	11.2 (160)	11.2 (160)	11.2 (160)	11.2 (160)	11.2 (160)	25.2 (360)	NA

Note: For ceiling heights > 60 feet, the design demand is based on the number of sprinklers at an end sprinkler pressure (i.e. 12 sprinklers at 7 psi end pressure).

9-7.3.5 Hose stream requirements must be in accordance with Table 9-4 unless otherwise modified by this UFC.

Table 9-4 Hose Stream Demand and Duration

Hazard Category	Hose Demand, gpm (lpm)		Duration, min
	Ceilings 60 ft (18.3 m) or less	Ceilings greater than 60 ft (18.3 m)	
Light	250 (950)	500 (1900)	60
Ordinary	250 (950)	500 (1900)	60
Extra	500 (1900)	500 (1900)	90

9-7.3.6 The design areas noted above or in NFPA 13, as applicable, must be increased by 30 percent for sloped ceilings that exceed a slope of 2 in 12.

9-7.3.7 The design area reductions in NFPA 13 for quick-response sprinklers are not permitted.

9-7.4 Sprinkler Coverage.

9-7.4.1 In *Facilities* protected by automatic sprinklers, sprinklers must provide coverage throughout the *Facility*.

9-7.4.1.1 Sprinklers may be omitted where permitted by NFPA 13, NFPA 13R or NFPA 13D, as applicable.

9-7.4.1.2 Sprinklers may be omitted from small rooms in specific occupancies in accordance with NFPA 101.

9-7.4.2 Sprinklers must be provided in electrical rooms, regardless of the fire resistance rated separation.

9-7.4.3 The use of extended coverage sprinklers is not permitted \2\except as noted below.

9-7.4.3.1 Extended coverage sprinklers may be used for the protection of loading docks.

9-7.4.3.2 Extend coverage sprinklers maybe used for the protection of historic structures and unique spaces subject to the written approval of the DFPE./2/

9-7.4.4 Listed or approved residential sprinklers are permitted to be used at their listed/approved spacing and coverage.

9-7.5 Hydraulic Calculations.

9-7.5.1 Sprinkler systems must be designed using hydraulic calculations.

9-7.5.1.1 Sprinkler systems permitted by this UFC to be supplied from the domestic plumbing may be designed using the pipe schedule method in NFPA 13.

9-7.5.1.2 The addition of no more than twenty sprinklers to an existing system is permitted to be designed using the pipe schedule based on the layout of the existing system.

9-7.5.2 Where the sprinkler system is supplied by interconnected risers, the sprinkler system must be hydraulically calculated using the hydraulically most demanding single riser. The calculations must not assume the simultaneous use of more than one riser.

9-7.6 Piping.

9-7.6.1.1 Galvanized piping is only permitted for deluge sprinkler systems, valve trim piping and drain piping exposed to the *Facility* exterior.

9-7.6.1.2 Black steel pipe must be used for the addition, repair or relocation of existing galvanized pipe in wet pipe, dry pipe or preaction systems.\2\

9-7.6.2 /2/Piping 2-in. (50 mm) and less must be minimum schedule 40. Piping larger than 2-in. (50 mm) must be minimum schedule 10. \2\For DLA, use Schedule 40 steel piping for all sprinkler systems and all pipe sizes.

- 9-7.6.3** CPVC is only permitted for residential occupancies.
- 9-7.6.4** Plain end fittings with mechanical couplings and fittings that use steel gripping devices to bite into the pipe are prohibited.
- 9-7.6.5** Steel piping with wall thickness less than schedule 40 must not be threaded.
- 9-7.6.6** Saddle tees using rubber gasket fittings are only permitted when connecting to existing piping for additions or modifications. Saddle tees must use a connection method that completely wraps around the pipe.
- 9-7.6.7** Fittings, mechanical couplings, and rubber gaskets must be from the same manufacturer.
- 9-7.6.8** The use of flexible sprinkler hose with fittings intended for direct connection to sprinklers must be approved by the AHJ.
- 9-7.6.9** Changes in pipe sizes must be made through tapered reducing pipe fittings.
- 9-7.6.10** Threaded fittings must use Teflon tape or manufacturer's approved joint compound.
- 9-7.7** Nitrogen Generation Systems.
- 9-7.7.1** Design the nitrogen generation system so all equipment is installed within the confines of the riser room with the exception of a connection for a manual gas analyzer.
- 9-7.7.2** Provide a nitrogen generation system that is capable of delivering a minimum of 98 percent nitrogen composition throughout all of the system piping within 14 days from the commencement of the inerting process.
- 9-7.7.3** The nitrogen generation system must be self-contained with "drop-in" operability with a simple one step direct connection of the nitrogen gas supply line to each zone.
- 9-7.7.4** The use of stand-alone compressed nitrogen bottle system is not permitted.
- 9-7.7.5** A process that involves continuous venting of the piping network is not permitted.
- 9-7.7.6** Any air maintenance device used in conjunction with the nitrogen generation system must be listed or approved for use on sprinkler systems.
- 9-7.8** Preaction Systems.

9-7.8.1 Preaction systems must utilize nitrogen complying with the "Nitrogen Generation Systems" section of this UFC.

9-7.9 Dry Pipe Systems.

9-7.9.1 Dry pipe systems must utilize nitrogen complying with the "Nitrogen Generation Systems" section of this UFC.

9-7.9.2 The delivery of water from the dry pipe valve to the system test connection must not exceed 60 seconds. Water delivery times must be measured starting at the normal nitrogen pressure on the system.

9-7.9.3 All rubber gasket grooved-end pipe fittings for dry pipe systems must be listed or approved for dry pipe systems.

9-7.10 System Requirements.

9-7.10.1 Provide a minimum clearance of 3 feet (915 mm) access to and in front of all equipment and 6-in. (150 mm) behind the equipment (e.g., control valves, backflow preventer, check valves, floor control valve assemblies, waterflow switches, etc.).

9-7.10.2 Thrust rod all pipe penetrations through the grade floor slab, unless flanged or welded joints are used throughout the below slab piping. All pipe penetrations through the grade floor slab must be sleeved and sealed.

9-7.10.3 The *QFPE* must coordinate with the Structural Engineer to determine the proper seismic design category for the project, in accordance with the IBC or ASCE guidelines. Seismic restraint is not required for Seismic design category A or B, except as otherwise required in this UFC.

Note: See UFC 3-310-04 for more information.

9-7.10.4 Drain and Test Connections.

9-7.10.4.1 Provide a permanently piped drain/test connection for each waterflow switch, including the waterflow switch for elevator power shunt.

9-7.10.4.2 Terminate all main drains and inspector's test connections piping to the exterior of the *Facility* so it will not cause damage. Discharge to the exterior must not interfere with exiting from the *Facility*. Water discharge or runoff must not cross an exit or exit discharge path. Do not discharge to the roof.

9-7.10.4.3 Termination points interior to the building are permitted to be approved by the *DFPE* when exterior termination is not practical.

9-7.10.4.4 Provide concrete splash blocks at all drain and inspector's test connection discharge locations if not discharging to a concrete surface. Splash blocks must be large enough to mitigate erosion and must not become dislodged during a full flow of the main

drain. Ensure all discharged water drains away from the *Facility* and does not cause property damage.

9-7.10.4.5 Any drains, test connection pipe, etc., that penetrate the exterior wall must do so no greater than 2 feet (610 mm) above finished grade, and at no time below grade.

9-7.10.4.6 The drain/test connection must be piped to a location that will accept full flow and will not cause property damage when water is discharging.

Note: Comply with any applicable state or local environmental requirements pertaining to the handling of sprinkler discharge water.

9-7.10.5 Individual floor control assemblies are to be provided for each respective floor when there are three or more floor levels. Floor area meeting the IBC definition of a mezzanine is not considered a floor level when applying this requirement.

9-7.10.6 Provide a dedicated control valve assembly for piping serving rooms that require shunt-tripping of equipment power prior to or simultaneously to the application of water. Locate the control valve assembly outside of the area it serves in an easily accessible identified location.

9-7.10.7 Normally open valves required by NFPA 13 or NFPA 13R \4V4/to be supervised must be electrically supervised (i.e. tamper switch).

9-7.10.8 Normally closed valves required by NFPA 13, NFPA 13R or NFPA 13D to be supervised must be locked or sealed, unless otherwise required by this UFC.

9-7.10.9 Provide listed or approved sprinkler guards for sprinklers that are less than 7 feet (2.1 m) above finished floor (in unfinished areas) or subject to mechanical damage or can be grabbed from the floor level.

9-7.10.10 Sprinklers installed in any detention areas, regardless of the *Facility* occupancy classification, must be listed/approved institutional sprinklers.

9-7.10.11 Piping up to the backflow preventer, when the fire protection system is connected to a domestic water source, must be disinfected. Disinfection of all other aboveground fire protection system piping is not required.

9-7.11 Family Housing.

When sprinkler systems are provided in family housing in geographic locations having a 99.6% dry bulb temperature less than 32°F (0°C) per UFC 3-400-02 Engineering Weather Data, sprinkler piping is prohibited from being located in attic spaces or exterior walls (except for the incoming service). Locate upper story piping only in interior walls and utilize sidewall sprinklers.

9-8 WATER SPRAY SYSTEMS.

Water spray systems must comply with NFPA 15 and the "Fire Suppression Systems" requirements of this UFC.

9-9 FOAM SYSTEMS.

9-9.1 General.

9-9.1.1 Foam systems must comply with NFPA 11 and NFPA 16, and the "Fire Suppression Systems" requirements of this UFC, except as modified below.\4\

9-9.1.2 /4/New systems must use potable water or a water source that is supplied from a potable water system (i.e. a water storage tank that is filled from a potable water system). The use of saltwater, brackish or other untreated water source must be approved by the *AHJ*.

9-9.1.3 Foam storage tanks must be labeled indicating vendor, model, type, and quantity of foam held within the tank via permanent sign.

9-9.1.4 \2\Consider all local environmental regulations to determine the control, treatment and/or remediation measures for the discharge of fire suppression effluent./2/

9-9.2 Piping.

9-9.2.1 Foam solution piping must be schedule 40 steel pipe.

9-9.2.2 Foam concentrate piping must be stainless steel pipe with roll grooved fittings, welded joints and fittings, or flanged joints and fittings. If using welded joints and fittings, consideration must be given to the maintenance of the system and provide flanged joints at certain locations to allow for the ease of maintenance and equipment removal. Gasket material must be approved by the foam concentrate manufacturer.

9-9.2.3 Any concealed concentrate piping must use welded or flanged fittings.

9-9.2.4 Trim piping on all deluge valves, flow control valves, and alarm check valves must be brass.

9-9.2.5 Foam concentrate lines must be located above grade.

9-9.3 Aqueous Film-Forming Foam (AFFF) \4\System/4/.

9-9.3.1 \4\Installation of a new AFFF system is prohibited.

9-9.3.2 Discharged AFFF solution must be contained and collected. The containment and collection system must use double-walled fiberglass storage tank(s) for collection of the AFFF solution. The piping to and from the tank(s) must be double-walled piping./4/

9-9.3.3 Foam Systems that utilize AFFF must only use AFFF concentrate meeting Military Specification MIL-F-24385F.

9-9.4 Foam Concentrate Pumps.

Foam concentrate pumps must be used where the distance from the tank to the proportioner exceeds 50 feet (15.3 m), or the manufacturer recommended distance based on water supply, whichever is less.

9-9.5 Foam Concentrate Storage Tanks.

9-9.5.1 Foam concentrate storage tanks can be atmospheric or horizontal bladder.

9-9.5.2 Do not use vertical bladder tanks.

9-9.5.3 Atmospheric tanks must be translucent or opaque, double-walled, polyethylene.

9-9.6 Foam Concentrate Control Valves.

9-9.6.1 For automatic control of foam concentrate, provide valves listed or approved for use with foam concentrate.

9-9.6.2 Isolation control valves must be full port ball type with an operating handle that indicates the on/off position of the valve. Unit must be socket weld or flanged type. Valve body and ball must be 316 stainless steel complying with ASTM A351.

9-9.6.3 All foam system valves affecting foam delivery must be electrically supervised for correct position.

9-9.7 Foam Concentrate Spill Control.

9-9.7.1 Spill control must be provided around foam storage tank(s) to help prevent spilled/leaked foam concentrate from reaching any drains.

9-9.7.2 Spill control must consist of a minimum 4-in. (100 mm) high concrete berm or similar and sized for the full volume of the tank. Double-walled polyethylene tanks can qualify as acceptable spill control provided there are no taps or outlets in the sides or bottom of the tank.

9-9.8 Test Liquid.

Surrogate test liquid (alternate test liquid) is permitted to be used for initial acceptance testing and routine testing if the liquid and test method is approved by a *DoD Component*.

9-9.9 Foam Discharge.

Foam solution discharge for maintenance and testing purposes must be in accordance with local *Installation* environmental requirements.

9-10 STANDPIPE SYSTEMS.

9-10.1 General.

When required, standpipe systems must comply with NFPA 14 and the "Fire Suppression Systems" requirements of this UFC, except as modified below.

Residual pressure requirements for *Facilities* under 150 feet (45 m) in height may be met by fire department apparatus when hydraulic calculations demonstrate that fire department apparatus can provide the required pressure via the building fire department connection(s) with 150 psi at the FDC.

9-10.2 Class I Standpipe Systems.

9-10.2.1 A Class I standpipe system must be provided in all required exit stairs of *Facilities* four stories or more in height.

9-10.2.2 For *Facilities* less than four stories in height, provide a Class I standpipe system where all portions of the building (on any floor) cannot be reached from an exterior door in less than 450 feet (140 m).

9-10.2.2.1 When required by this section, standpipes must be installed in all required exit stairs and on both side of horizontal exits.

9-10.2.3 Standpipes and hose valves must not encroach into the means of egress especially on stair landings.

9-10.3 Class II and III Standpipes.

Class II and III standpipes, as defined in NFPA 14 are not permitted.

9-11 DRY CHEMICAL EXTINGUISHING SYSTEMS.

Note: Fixed dry chemical extinguishing systems are appropriate for the protection of certain types of special occupancies, hazards, and facilities such as dip tanks, and other operations involving flammable liquids.

9-11.1 General.

Dry chemical extinguishing system must comply with NFPA 17 and the "Fire Suppression Systems" requirements of this UFC, except as modified below.

9-11.2 Limitations.

Dry chemical agents must not be used to protect sensitive electronics. Dry chemical extinguishing systems must not be used for the protection of cooking equipment.

9-12 **WET CHEMICAL EXTINGUISHING SYSTEMS.**

Note: Fixed wet chemical extinguishing systems are suitable for protection of certain types of special occupancies, hazards, and facilities, such as cooking surfaces, cooking exhaust systems, and dip tanks.

9-12.1 General.

Wet chemical extinguishing systems must comply with NFPA 17A and the "Fire Suppression Systems" requirements of this UFC, except as modified below.

9-12.2 Testing.

Testing must be performed by liquid discharge, utilizing the manufacturer's recommended flushing concentrate, to demonstrate equal distribution of chemical and no leakage at pipe joints.

9-13 **CLEAN AGENT FIRE EXTINGUISHING SYSTEMS.**

Note: Clean agent fire extinguishing systems are suitable for protection of certain types of special occupancies, hazards, and facilities.

9-13.1 General.

9-13.1.1 Clean agent fire extinguishing systems must comply with NFPA 2001 and the "Fire Suppression Systems" requirements of this UFC, except as modified below.

9-13.1.2 Clean agent fire extinguishing systems are not permitted to substitute for required automatic sprinkler systems.

9-13.1.3 Fire extinguishing agents that have been identified for future manufacturing or use limitations must not be used, regardless if current installation is permitted by regulatory authorities in the country of application.\1V1/

9-13.2 Requirements.

9-13.2.1 Provide stand-alone (not dependent upon the *Facility* fire alarm system for operation) control panels that are listed for releasing device service and monitored by the *Facility* fire alarm system.

9-13.2.2 Careful consideration must be given to compartment under/over-pressurization during the discharge of total flooding clean agent systems. Pressure relieving vents, located near the finished ceiling, may be necessary to regulate rapid

pressure changes during discharge. Comply with the manufacturer's recommended procedures relative to enclosure venting.

9-13.2.3 Provide a manually activated permanent exhaust system to facilitate the extraction of any remaining clean agent after the required hold time of the total flooding clean agent system.

9-13.2.3.1 The exhaust system can be integrated into the HVAC system for the enclosure, but in no case designed for less than six air changes per hour.

9-13.2.3.2 The manual activation switch must be located outside of the protected area.

9-13.2.3.3 Permanent signage must be provided indicating "Fire Suppression Exhaust System – Fire Department Use Only".

9-14 WATER MIST FIRE PROTECTION SYSTEMS.

Note: Water mist fire protection systems are suitable for protection of certain types of special occupancies, hazards, and facilities. Water mist fire protection systems are not a substitute for required automatic sprinkler systems.

9-14.1 General.

9-14.1.1 Water mist fire protection systems must comply with NFPA 750 and the "Fire Suppression Systems" requirements of this UFC, except as modified below.

9-14.1.2 Provide stand-alone (not dependent upon the *Facility* fire alarm system for operation) control panels that are listed for releasing device service and monitored by the *Facility* fire alarm system.

9-15 CARBON DIOXIDE SYSTEMS.

Note: Carbon dioxide (CO₂) systems are normally effective against flammable liquid (Class B) and energized electrical (Class C) fires.

9-15.1 General.

9-15.1.1 Carbon dioxide system must comply with NFPA 12 and the "Fire Suppression Systems" requirements of this UFC, except as modified below.

9-15.1.2 New total flooding systems are not permitted in normally occupied areas.

9-15.1.3 Do not locate CO₂ piping in any area where a pipe break or leak could make a normally occupied area untenable.

9-15.1.4 Careful consideration must be given to compartment under/over-pressurization during the discharge of total flooding CO₂ systems. Comply with NFPA 12 and the manufacturer's recommended procedures relative to enclosure venting.

9-15.1.5 Provide a manually activated exhaust system to facilitate the extraction of any remaining CO₂ after the required holding time of the total flooding CO₂ system. The exhaust system can be integrated into the HVAC system for the enclosure but in no case \2\2/ designed for less than six air changes per hour. The manual activation switch must be located outside of the protected area.

9-16 HALON 1301 SYSTEMS.

9-16.1 General.

Installation of a new Halon 1301 system is prohibited except by special approval of \1\Service Signature Authority/1/.

9-16.2 Halon Turn-In Procedures.

For projects involving the demolition of existing Halon 1301 systems, refer to the following for turn-in requirements: <http://www.dla.mil/aviation>

9-17 PORTABLE FIRE EXTINGUISHERS.

9-17.1 General.

General purpose portable fire extinguishers \4\must be provided where required by NFPA 101./4/

9-17.2 Location.

9-17.2.1 When provided, portable fire extinguishers must be located in accordance with NFPA 10.

9-17.2.2 If provided in *Electronic Equipment Areas*, clean agent type portable fire extinguishers must be used.

9-17.2.3 Portable fire extinguishers utilizing carbon dioxide (CO₂) are only permitted to be used in enclosed rooms if they exceed 1,000 ft² (92.9 m²).\2\

9-18 /2/FIRE ALARM SYSTEMS.

9-18.1 General.

\4\Provide fire alarm systems when required by NFPA 101 or when automatic detection or suppression systems are required./4/

9-18.1.1 Fire alarm systems (detection and notification) must comply with the applicable provisions of NFPA 72 and the ABA, except as modified by this UFC.

9-18.1.1.1 Buildings or portions of the building that are not required to comply with ABA/ABAAG, must still comply with NFPA 72.

9-18.1.2 Fire alarm systems must be independent, stand-alone systems that are not an integral part of a security, energy monitoring and control system (EMCS), or other system.

9-18.1.2.1 The fire alarm system must be combined with a *Facility* mass notification system or with a combination *Facility* mass notification and public address system when mass notification is required by UFC 4-010-01. The fire alarm system, or combined *Facility* mass notification and fire alarm system, may be separate from a public address system.

9-18.1.2.2 The fire alarm system is permitted to be connected to the EMCS or similar system to affect shutdown of HVAC units that require shutdown according to UFC 4-010-01 and UFC 4-021-01, but are otherwise not required to be controlled by the fire alarm system.

9-18.1.2.3 Fire alarm systems may be connected to security systems or an EMCS for monitoring purposes only, but must in no way rely on those other systems for operation or reporting.

9-18.1.3 Wireless interior fire alarm systems and devices are not permitted.

9-18.2 Plans and Calculations.

For new or modified systems, construction (shop) drawings and calculations must be prepared by an individual that has obtained National Institute for Certification in Engineering Technologies, Fire Alarm Systems, Level III certification, at a minimum. The *QFPE* must review the shop drawings, calculations and material submittals. The shop drawings must bear the *Review Stamp* of the *QFPE* prior to submitting the fire alarm system shop drawings to the *DFPE*.

For Army, construction (shop) drawings and calculations must be prepared by, or prepared under the immediate supervision of, the *QFPE*. The *QFPE* must affix their professional engineering stamp with signature to the shop drawings, calculations and material data sheets, indicating approval prior to submitting the fire alarm system shop drawings to the *DFPE*. The *QFPE* must monitor the installation of the fire alarm system and certify in writing that the fire alarm system has been constructed and operates as intended in the design plans and specifications.

9-18.3 *Fire Alarm Reporting System.*

9-18.3.1 *Fire Alarm Reporting Systems* must conform to NFPA 72 and NFPA 70.

9-18.3.2 The *Facility* fire alarm system must be connected to the *Fire Alarm Reporting System*.

9-18.3.3 The following signals, at a minimum, must be transmitted via the *Fire Alarm Reporting System*:

- a. Alarm signal by device type (e.g., waterflow, manual pull station, sleeping room smoke detector).
- b. General supervisory signal.
- c. General trouble signal.

9-18.3.4 New exterior fire alarm boxes are not required at DoD *Installations*, nor is it required to replace existing boxes that are not needed for the transmission of automatic alarms.

9-18.3.5 *Fire Alarm Reporting Systems* must provide the following where applicable:

- a. Transmission of coded signals to fire department headquarters or other central locations;
- b. Permanent record of alarm signal, time, and date;
- c. Automatic supervision of alarm initiating circuits;
- d. Automatic testing of radio signaling devices;
- e. A dedicated transmitter that will transmit alarm, supervisory and trouble signals for each *Facility*; and
- f. Transmitters must be listed or approved for use with the existing *Fire Alarm Reporting System*.

9-18.4 Control Panels.

9-18.4.1 The fire alarm control panel must be analog/addressable, site programmable panel, and must have, or be capable of, the following:

- a. The ability to store at least 400 events in the history log. These events must be stored in a non-volatile memory and remain in the memory until the memory is downloaded or cleared manually.
- b. Resetting of the control panel must not clear the memory from being retrieved on the integral LCD display.
- c. An integral LCD 80 character (minimum) alphanumeric display.
- d. Provide all smoke detectors connected to the FACP with an adjustable alarm verification feature. Initially set the alarm verification at 20 seconds.

Existing fire detection systems that are controlled by *Facility* management, energy or utility management systems are permitted to remain.

9-18.4.1.1 A conventional control panel is permitted to be used for systems monitoring sprinkler system alarm, supervisory and trouble conditions only as permitted by NFPA 101 (e.g. a warehouse).

9-18.4.2 \3\3/Locate the control panel and supplemental control panels in a year-round environmentally conditioned space within the *Facility* that complies with the environmental conditions required in the panel approval or listing.

Note: Environmental condition values (temperature and humidity) are taken from UFC 3-400-02.

9-18.4.3 If the fire alarm control panel is not located at the designated primary entrance, provide a remote annunciator at the designated primary entrance unless directed otherwise by the contract documents. Provide remote annunciator with control functions the same as the main control panel. Control functions must be accessible only by user code or secured behind a locked panel.

9-18.5 Detection.

Note: Detection systems, especially smoke detection systems, require significant maintenance. It is critical that the required detectors are properly installed and maintained. Providing detectors in locations that are not required increases the already high maintenance costs of alarm systems and strains the maintenance program for critical detection systems. If a *Facility* warrants protection and criteria does not require detection, protection must be accomplished by a wet pipe sprinkler system. Wet pipe sprinklers provide superior protection with little maintenance.

9-18.5.1 General.

9-18.5.1.1 Fire detection systems must be provided in areas required by this UFC or where required by NFPA standards and must be limited to these applications unless an *Exemption* is approved\1\1/.

9-18.5.1.2 The area of protection for smoke detection devices permitted by NFPA 72 must be reduced by 50 percent where destratification (ceiling) fans are used (e.g., this may require additional smoke detectors for that area being protected).

9-18.5.1.3 The above reduction is in addition to any other reductions in spacing required by NFPA 72 (e.g., high ceiling, high air-flow).

9-18.5.2 Requirements.

Detection systems must be arranged to alert *Facility* occupants and to transmit an alarm signal via a *Fire Alarm Reporting System*.

9-18.6 Notification.

9-18.6.1 Notification must be provided throughout the entire *Facility* where required by NFPA 101\4\4/.

9-18.6.2 Where a mass notification system is required, fire alarm notification must be via a voice evacuation system and must serve as the method of notification for the mass notification system.

9-18.6.3 Audible and Visible Notification Appliances.

- a. Provide a minimum of one notification appliance circuit per floor. Each notification appliance circuit must include 25 percent spare capacity.
- b. Sleeping room speakers must produce a 520 Hz signal temporal three (T3) signal for fire in accordance with NFPA 72.
- c. Provide a 520 Hz signal temporal four (T4) signal for carbon monoxide in accordance with NFPA 72 when required by the "Carbon Monoxide (CO) Detection" section of this UFC.
- d. The provision of a sounder base does not negate the requirement of the *Facility's* audible notification appliances for each sleeping room.
- e. The performance requirements for audible notification must be met with all doors, fire shutters, movable partitions, and other similar devices closed.
- f. Visible notification must be provided in all normally occupied, public and common use areas (e.g., break rooms, corridors, auditoriums or conference rooms).
- g. Visible notification must be provided in all normally unoccupied areas (such as mechanical rooms, electrical rooms, janitor rooms, storage areas, communication closets and other similar spaces) greater than 900 ft² (84 m²).
- h. Visible notification is required in any normally unoccupied area where the ambient noise is loud enough to require hearing protection (e.g., compressor room).
- i. Visible notification must be provided in all offices that are designed for, or may contain, more than four persons at any one time. For Air Force, visual notification must be provided in all offices that are designated for, or may contain, two or more persons at any one time.

Note: This must be determined by the furniture plan. If \3more than four/3/ chairs with work surfaces are assigned to the room, visible notification is required. For Air Force if two or more chairs (with or without work surfaces) are assigned to the room, visual notification is required.

- j. Visible notification is not required in single person offices, unless the office is assigned to a person with a hearing impairment that would require a visible notification appliance.

- k. Visible notification is not required in bathrooms serving single person offices, unless the office is assigned to a person with a hearing impairment that would require a visible notification appliance.
- l. Visible notification appliances must be provided with a clear lens marked "Alert". The use of "Fire" is not permitted.

9-18.6.4 Mass Notification System (MNS).

Refer to UFC 4-021-01.

9-18.6.5 Voice Message.

For systems using voice evacuation or combined with the mass notification system, the default fire alarm voice evacuation message should be a female voice and state the following:

(Temporal 3 Alert Tone) "May I have your attention please. May I have your attention please. A fire emergency has been reported in the building. Please leave the building by the nearest exit or exit stairway. Do not use the elevators". <provide a 2 second pause> "May I have your attention please..." (repeat the message).

Installations with formally established and approved/published in accordance with the Service/Agency policy standard signals and messages are permitted to utilize those standard signals and messages. The general format must be a specific alert signal tone(s) followed by a voice announcement(s) and then repeats the cycle for a specific number of cycles or continuously as appropriate for the message.

Note 1: For single-story *Facilities*, delete "or exit stairway. Do not use the elevators" from the voice message.

Note 2: See "Appendix E" for guidance on other messages.

9-18.7 Initiating Devices.

9-18.7.1 Sprinkler Waterflow.

Provide a separate address for each sprinkler waterflow switch.

9-18.7.2 Sprinkler System Supervisory Air or Gas.

Monitor high and low air or gas pressure on dry pipe and preaction systems on a per riser room basis as a supervisory function with the *Facility* fire alarm system.

9-18.7.3 Valve Tamper.

No more than five adjacent valve tamper switches within the same room are permitted to be monitored by the same addressable device or supervisory circuit.

9-18.7.4 Manual Pull Station.

9-18.7.4.1 \2\Manual pull stations must be provided at all exits, regardless of occupancy. Manual pull stations must be located within five feet of the exit door. The 200 foot travel distance to a manual pull station noted in NFPA 101 is not applicable./2/

9-18.7.4.2 Provide addressable double-action type manual pull stations with mechanical reset features. If the manual pull station requires a key for reset, it must be the same key as required for the fire alarm control panel.

9-18.7.4.3 Conventional single-action manual pull stations are permitted in hazardous areas, wet and damp locations, and other areas where specialty listings are required. Where a conventional manual pull station is used, it must be provided with a separate address.

9-18.7.5 Smoke Detection.

9-18.7.5.1 Provide 24 Vdc photoelectric smoke detectors in all sleeping rooms and duty rooms located in business or other occupancies. Not applicable to inpatient sleeping rooms of healthcare occupancies.

9-18.7.5.2 Upon detection of smoke, an audible signal must be activated in the respective sleeping room, dwelling unit/suite or duty room, send a distinct signal to the *Facility* fire alarm control panel, if required by other sections of this UFC, and to the *Installation* fire reporting system, but not activate the *Facility* notification appliances.

9-18.7.5.3 See Chapter 4 for Open Bay Personnel Housing.

9-18.7.5.4 The audible signal must be low frequency as required by NFPA 72.

9-18.7.6 Under-floor Smoke Detector Identification.

When under-floor smoke detectors are provided, provide a framed CAD drawn floor plan showing the location of the devices in the room and their corresponding address. Locate a single framed drawing of the location of the smoke detectors outside of the space and adjacent to the main entrance.

9-18.8 Power Disconnect.

For disconnecting power supplies, provide listed control relays located within 3 feet (915 mm) of the shunt trip breaker. Operation of relay must be controlled by a listed fire alarm control unit. Relay must function within the voltage and current limitations of the fire alarm control unit. Relay contacts must be listed for the connected load.

9-18.9 Wiring, Circuits and Conduit.

9-18.9.1 Class B pathways for addressable detection, notification, and signaling line circuits meet all minimum/necessary DoD performance requirements.

9-18.9.2 All conductors must be installed in conduit (EMT minimum).

9-18.9.3 Conductors.

9-18.9.3.1 Pull all conductors splice free; conductors must be continuous from device to device. The use of wire nuts, crimped connectors, or twisting of conductors is prohibited.

9-18.9.3.2 Run all wiring to and within control panels in the vertical or horizontal plane, make all turns at 90 degree angles, and tightly bundle, wrap, and identify all conductors individually with permanent markings. Conductor markings must be printed labels, permanently affixed to the conductor via shrink wrap.

9-18.9.4 Conductor Type.

9-18.9.4.1 Wiring may be solid copper or stranded as permitted by NFPA 70.

9-18.9.4.2 All signaling line circuits must be minimum 18 AWG. Initiating device and notification appliance circuits must be minimum 16 AWG.

9-18.9.4.3 Initiating device circuits used for optical flame detection devices must use shielded cable.

9-18.9.5 Device Termination.

All devices must have screw terminals. Where devices are only provided with pigtails from the manufacturer, pigtails must be landed on terminal strips mounted within the junction box.

9-18.9.6 Conductor Terminations.

All terminations must be at a terminal strip or the device screw terminals. Terminal strips are only permitted where direct connection to a device is not possible. (e.g., pigtails off a rate-compensating heat detector).

9-18.9.7 Identification.

9-18.9.7.1 In unfinished areas, all conduit, junction/back boxes, covers, and couplings, when provided, must be factory painted red (e.g., above ceilings, mechanical rooms, concealed spaces, etc.).

9-18.9.7.2 In finished areas, all exposed conduit, junction/back boxes, covers and couplings, when provided, must be factory painted red or conduit, junction/back boxes, covers, and couplings are permitted to be painted to

match the room finish and/4/ the inside cover of the junction box must be identified as "Fire Alarm"4\4/.

9-18.10 Surge Suppression.

9-18.10.1 Provide surge suppression (SPD) for all signaling line circuits, indicating device circuits, or notification appliance circuits that leave or enter a *Facility's* exterior enclosure.

9-18.10.2 SPD must be provided at the first location where connections are made that is close to where the circuit enters or leaves the *Facility*, prior to connection to any other devices when feasible.

9-18.10.3 SPD is not required for devices connected directly to the *Facility* exterior when the *Facility* itself is provided with lightning protection (i.e. an electric bell or speakers mounted on the exterior wall of the *Facility*.)

9-18.11 Power.

9-18.11.1 Provide primary power in accordance with UFC 3-520-01. This includes the provision of a lock-on circuit breaker.

9-18.11.2 Provide SPD on all 120 Vac circuits to control panels, subpanels, transmitters, amplifier panels, and booster panels. SPD must have both a UL 1449 and UL 1283 listing and must be located in an adjacent hinged terminal box.

9-18.11.3 Secondary Power.

Provide rechargeable batteries per NFPA 72 to operate the fire alarm system under supervisory conditions for 48 hours and all alarm devices for an additional 15 minutes. Where the fire alarm system also serves as a mass notification system, refer to UFC 4-021-01 for additional requirements.

9-18.12 Releasing Control Panels.

9-18.12.1 In addition to the requirements specified above for fire alarm control panels, panels used for control or release of fire suppression systems must be listed by a NRTL for releasing service.

9-18.12.1.1 Provide a separate releasing panel independent of the *Facility* fire alarm system panel to activate the system.

9-18.12.1.2 A combined fire alarm/releasing panel is permitted for small *Facilities* with the approval of the *DFPE*.

9-18.12.2 Electronic solenoids used for release of the suppression system must be listed by a NRTL for use with both the releasing panel and the suppression equipment.

9-18.12.3 Provide rechargeable batteries per NFPA 72 to operate the releasing panel under supervisory conditions for 48 hours and alarm conditions for an additional 15 minutes. Include the full current draw of the solenoid in the battery calculations.

9-18.12.4 When more than one panel is used, each panel must be monitored independently by the *Facility* fire alarm control panel.

9-18.12.5 Locate the panel adjacent to, but not in, the hazard/area served. The releasing panel and supplemental control panels must be located in a year-round environmentally conditioned space that complies with the environmental conditions required in the listing.

9-18.12.6 When required, pre-discharge and discharge alarms must consist of audible and visible notification appliances that are different than the *Facility* fire alarm system notification appliances.

9-19 CARBON MONOXIDE (CO) DETECTION.

9-19.1 General.

9-19.1.1 Provide carbon monoxide detection in facilities with combustible fuel burning equipment (e.g., air handling units, heaters, stoves, fireplaces).

9-19.1.2 Carbon monoxide detection must conform to the requirements of NFPA 72 and the manufacturer's requirements, except as modified by this UFC.

9-19.1.3 Carbon monoxide detectors must be powered by the fire alarm control panel (i.e. 24 Vdc). Where a fire alarm system is not provided, 120 Vac \2\ carbon monoxide alarms/2/ are permitted.

9-19.2 Installation.

9-19.2.1 Detectors must be located in each room/space where the fuel burning appliances(s) are located.

9-19.2.2 \2\Where HVAC equipment utilizes fuel burning equipment, one detector must be located downstream of the fuel burning equipment./2/

9-19.2.3 \3\For large open spaces with ceiling heights greater than 12 feet, i.e, storage facilities, aircraft hangar bay, large industrial spaces, and similar spaces, carbon monoxide detection is not required./3/

9-19.3 Notification.

9-19.3.1 Where a fire alarm voice evacuation system is provided, activation of a carbon monoxide detection device must initiate a unique voice notification message.

9-19.3.1.1 The alert signal portion of the voice alarm message for carbon monoxide detection must be a 520 Hz temporal 4 (T-4) signal. The alert signal must repeat twice before the voice announcement.

9-19.3.1.2 A sample message is as follows: (Temporal 4 Alert Tone)
"Attention...Attention....Carbon monoxide has been detected in the building. Please leave the building by the nearest exit." (Temporal 4 Alert Tone)

9-19.3.2 Where a voice evacuation system is not provided, activation of a carbon monoxide detector must initiate an audible alarm distinctly different from other audible alarm signals in the *Facility*. Distinct visible notification is not required.

9-19.3.3 When part of the fire alarm system, activation of a carbon monoxide detector must send a separate "carbon monoxide detector" alarm signal to the *Fire Alarm Reporting System*.

9-19.3.4 Sleeping room audible appliances must provide a 520 Hz temporal 4 (T4) signal for carbon monoxide in accordance with NFPA 72. The provision of a sounder base does not negate the requirement of the *Facility's* audible notification appliances for each sleeping room."

9-20 SMOKE CONTROL SYSTEM

9-20.1 General.

9-20.1.1 Design must be in accordance with NFPA 92.

9-20.1.2 Design parameters must be documented and be based on industry standards of practice, such as the SFPE Handbook of Smoke Control Engineering. Other source documents, such as peer-reviewed research articles, may be used with approval of the *DFPE*.

9-20.1.3 Controls must be designed and listed as required by NFPA 92.

9-20.1.4 Fire alarm control unit must be ANSI/UL 864, category UUKL listed.

9-20.1.5 HVAC controls must be ANSI/UL 864, category UUKL listed where required by NFPA 92.

9-20.1.6 Fire alarm system sequence of operations matrix must include all automatic and firefighter's smoke control station functions.

9-20.1.7 Design must include a preliminary test plan.

9-20.2 Installation.

9-20.2.1 Prior to installation and programming, provide a single submittal that includes all smoke control system components.

9-20.2.2 Submittal must document all aspects of integration between the involved systems and trades, such as the interface between the fire alarm and HVAC systems.

9-20.2.3 Documentation must include the physical interface and logic interface. Physical interface description must include location of control devices and wiring diagrams for all components. Logic interface description must include the complete sequence of operations, from input to final output.

9-20.2.4 Submittal must include an updated test plan, tailored to the specific devices and arrangements to be installed. Test plan must include all proposed test procedures.

9-20.3 Testing.

9-20.3.1 Testing must be in accordance with NFPA 92.

9-20.3.2 Individual components must be tested in accordance with the relevant UFC. For example, fire alarm system components must be tested in accordance with UFC 3-600-01 and NFPA 72. Fans must be tested in accordance with Air Movement and Control Association (AMCA) Publication 203.

9-20.3.3 Submit a revised test plan that incorporates any as-built conditions that differ from the smoke control submittal, prior to the start of any acceptance testing.

This Page Intentionally Left Blank

CHAPTER 10 MEANS OF EGRESS

10-1 GENERAL.

10-1.1 Requirements.

Comply with NFPA 101 for all components and features related to means of egress. IBC must not be used for any means of egress features, except as specifically noted below.

10-1.2 Accessible Means of Egress.

Comply with NFPA 101 for accessible means of egress.

10-2 MEANS OF EGRESS MARKING.

10-2.1 Requirements.

10-2.1.1 Incandescent or fluorescent fixtures are not permitted for new installation or replacement of fixtures.

10-2.1.2 Use of the graphic emergency exit symbols with and without directional arrows (NFPA 170 or Host Nation equivalents) in lieu of the text "EXIT" is permitted.

10-2.1.3 In locations outside the United States and its territories and possessions, additional markings may be required to remain consistent with local national standards; colors must be consistent with local national standards, and bilingual signs are recommended.

10-2.2 Radioluminous Exit Signs.

Radioluminous exit signs are not permitted in DoD *Facilities*.

10-2.3 Photoluminescent Exit Signs and Markings.

10-2.3.1 Photoluminescent exit signs and egress path markings are permitted and must be designed and installed per the requirements of NFPA 101. The charging light source must be continually illuminated at all times with normal power. The charging light source must not be on a switched circuit.

10-2.3.2 The illumination source must be energized at all times during building occupancy. Such lighting must not be controlled by automatic timers, automatic sensors including area occupancy sensors, or accessible manual switches. Controls for such lighting must be accessible only to authorized personnel.

10-3 OCCUPANT LOAD.

10-3.1 Occupant load factors.

Occupant load must be calculated in accordance with NFPA 101, except as noted in Table 10-1 below:

Table 10-1 Supplemental Occupant Load Factors

Use	Occupant Load Factor (sf/person)
Waiting spaces other than those in theaters and assembly occupancies where persons are admitted to the building at times when seats are not available	15 net
Exhibit galleries, museums	30 net
Courtrooms, hearing rooms – other than fixed seating areas	40 net
Conference rooms with tables and chairs	15 net
Community shelters (e.g., spaces designated for 'shelter in place' for $\sqrt{2}/2$ /hurricane, disaster recovery, or similar)	20 net
$\sqrt{2}$ Community shelters for tornado	7 net/ $\sqrt{2}$
Recreation – indoor tennis courts	50 gross
Recreation – squash, racquetball	4 per court
Locker rooms	50 gross or maximum anticipated number, whichever is higher
Bowling centers	5 persons per lane plus 7 net for additional areas
Dormitories (bunks)	50 gross
Mechanical, electrical, other building equipment spaces	500 gross
IT equipment rooms including those with small work areas in accordance with NFPA 75 or telecommunications rooms in accordance with NFPA 76	300 gross
Manufacturing areas	200 gross
Parking garages	200 gross
Telecommunications buildings (standalone)	500 gross
Aircraft hangars – aircraft storage and servicing areas	500 gross
Magazines and bunkers	Maximum anticipated number of personnel

10-3.2 Maximum occupant load.

The maximum occupant load for any space or *Facility* must not exceed one person per 7 ft² (0.65 m²) of net floor space or the maximum capacity of the required egress components, whichever is less.

10-4 STAIR TO ROOF ACCESS.

Stair to roof access must be in accordance with the IBC.

10-5 COMMUNICATING SPACE.

Communicating spaces must meet the open and unobstructed provision of NFPA 101. Smoke detection is not an alternative method of meeting this provision./5/

This Page Intentionally Left Blank

CHAPTER 11 ACCESSIBILITY

11-1 GENERAL.

For fire protection requirements, no changes to the IBC Chapter 11 provisions.

CHAPTER 12 INTERIOR ENVIRONMENT

12-1 GENERAL.

For fire protection requirements, no changes to the IBC Chapter 12 provisions.

CHAPTER 13 ENERGY EFFICIENCY

13-1 GENERAL.

For fire protection requirements, no changes to the IBC Chapter 13 provisions.

CHAPTER 14 EXTERIOR WALLS

14-1 GENERAL.

For fire protection requirements, no changes to the IBC Chapter 14 provisions.

CHAPTER 15 ROOF ASSEMBLIES AND ROOFTOP STRUCTURES

15-1 ROOF COVERINGS.

Use roof coverings approved and listed by a NRTL. Class C roof coverings, as defined in the UL Roofing Materials and Systems Directory are only permitted for single and duplex style housing and *Facilities* less than or equal to 5,000 ft² (465 m²).

15-2 ROOF DECK ASSEMBLIES.

15-2.1 General.

15-2.1.1 For non-sprinklered *Facilities* or *Facilities* \2\greater than or equal to/2/ 8,000 ft² (743 m²), roof deck assemblies must be FM Class I approved, or UL-listed as fire classified or equal listing or classification by an NRTL.

15-2.1.2 Where a non-combustible roof is installed over an existing combustible roof, the existing combustible roof materials must be removed or the space between the existing and new roof must be protected as a combustible concealed space per NFPA 13.

Note: FM Class I or II ratings and UL "Fire Classified" ratings are measures of the resistance, of the entire roof assembly, to ignition from exposure to a fire within the building, heating the underside of the roof deck. These two ratings cannot be equated and are not interchangeable.

15-2.1.3 Where the HVAC or similar equipment is located on the existing roof and not removed, the space between the existing and new roof must be protected as and considered a combustible concealed space per NFPA 13.

15-2.1.4 Roof top solar photovoltaic (PV) panels must be mounted to facilitate application of water from fire department vehicles to fires on the roof deck surface. Arrangement of PV panels must meet the requirements of UFC 3-440-01.

CHAPTER 16 STRUCTURAL DESIGN

16-1 GENERAL.

For fire protection requirements, no changes to the IBC Chapter 16 provisions.

CHAPTER 17 SPECIAL INSPECTIONS AND TESTS

17-1 GENERAL.

For fire protection requirements, no changes to the IBC Chapter 17 provisions.

CHAPTER 18 SOILS AND FOUNDATIONS

18-1 GENERAL.

For fire protection requirements, no changes to the IBC Chapter 18 provisions.

CHAPTER 19 CONCRETE

19-1 GENERAL.

For fire protection requirements, no changes to the IBC Chapter 19 provisions.

CHAPTER 20 ALUMINUM

20-1 GENERAL.

For fire protection requirements, no changes to the IBC Chapter 20 provisions.

CHAPTER 21 MASONRY

21-1 GENERAL.

For fire protection requirements, no changes to the IBC Chapter 21 provisions.

CHAPTER 22 STEEL

22-1 GENERAL.

For fire protection requirements, no changes to the IBC chapter 22 provisions.

CHAPTER 23 WOOD

23-1 FIRE RETARDANT TREATED (FRT) WOOD.

Conform to the requirements of IBC for permitted use of FRT wood. FRT plywood must not be used in any part of the roof or roofing system.

\2\2/

CHAPTER 24 GLASS AND GLAZING

24-1 GENERAL.

For fire protection requirements, no changes to the IBC Chapter 24 provisions.

CHAPTER 25 GYPSUM BOARD, GYPSUM PANEL PRODUCTS AND PLASTER

25-1 GENERAL.

For fire protection requirements, no changes to the IBC Chapter 25 provisions.

CHAPTER 26 PLASTIC

26-1 GENERAL.

For fire protection requirements, no changes to the IBC Chapter 26 provisions.

CHAPTER 27 ELECTRICAL

27-1 GENERAL.

For fire protection requirements, no changes to the IBC Chapter 27 provisions.

CHAPTER 28 MECHANICAL SYSTEMS

28-1 AIR HANDLING.

28-1.1 General.

Fire protection features for air handling, heating, ventilation, and exhaust systems, such as duct smoke detectors, fire dampers and smoke dampers, must comply with the requirements of NFPA 90A, except as modified by this UFC.

Duct smoke detectors are not required where air distribution systems are incapable of spreading smoke beyond the enclosing walls, floors and ceilings of the room or space in which the smoke is generated.

∨Duct smoke detectors are not required when the air distribution system supplies a space or room that has area smoke detection./2/

28-1.2 Plenums.

Plenums may be used as an integral part of an air handling system only if they conform to the requirements of NFPA 90A. Under no circumstances may combustible materials be located within the plenum space. Electrical wiring passing through the space, including telephone and communication wiring must be plenum rated or must be in metal conduit.

Rooms or areas that form a plenum space or that are used as a plenum must not be occupied for any purpose except during repairs or maintenance operations to the air handling equipment.

28-1.3 Computer Room Air Conditioning (CRAC).

28-1.3.1 CRAC units must not automatically shut down if electronic equipment remains energized and heat generated in the room will be sufficient to activate sprinkler heads.

CHAPTER 29 PLUMBING SYSTEMS

29-1 **GENERAL.**

For fire protection requirements, no changes to the IBC Chapter 29 provisions.

CHAPTER 30 ELEVATORS AND CONVEYING SYSTEMS

30-1 **GENERAL.**

For fire protection requirements, no changes to the IBC Chapter 30 provisions.

Comply with requirements of the "Elevators" section of this UFC.

CHAPTER 31 SPECIAL CONSTRUCTION

31-1 **GENERAL.**

For fire protection requirements, no changes to the IBC Chapter 31 provisions.

CHAPTER 32 ENCROACHMENTS INTO THE PUBLIC RIGHT-OF-WAY

32-1 **GENERAL.**

For fire protection requirements, no changes to the IBC Chapter 32 provisions.

CHAPTER 33 SAFEGUARDS DURING CONSTRUCTION

33-1 **GENERAL.**

For fire protection requirements, no changes to the IBC Chapter 33 provisions.

CHAPTER 34 EXISTING FACILITIES

34-1 GENERAL.

34-1.1 Minimum Requirements.

Facilities, as they exist, must meet the requirements of NFPA 101, for existing occupancies. *Facilities* that do not meet the requirements of NFPA 101 for existing occupancies must conform to one of the following:

- a. Upgrade the deficiency to meet the existing occupancy requirements, or
- b. Establish management protocols to provide a level of life safety equivalent to that required by NFPA 101 for existing occupancies, until an upgrade project can be completed. Management protocols must be in writing and approved by the *AHJ*.

34-1.2 Work in Existing Facilities.

34-1.2.1 Conform to the requirements of the Building Rehabilitation chapter of NFPA 101 for design and construction projects in existing buildings \5\ except as specified in this UFC.

The entire facility, at a minimum, must comply with the applicable existing occupancy chapter of NFPA 101 before beginning the project for work in existing facilities. The project may include bringing the facility into compliance with the applicable occupancy chapter of NFPA 101. /5/

[C] 34-1.2.1

The areas of the facility where no work is being performed must meet the applicable existing occupancy chapter of NFPA 101. Thus if the work involves 5,000 ft² of an existing 15,000 ft². office building, then the remaining 10,000 ft² not involved in the project must be brought up to meet the applicable existing occupancy chapter of NFPA 101 before beginning the project or be included as part of the project.

34-1.2.2 Where multiple categories of rehabilitation work are planned as part of a single project, identify each category of rehabilitation work to be performed, including what is required and what will be provided, within each one.

34-1.2.3 Phasing of construction and demolition operations must be planned so that the integrity of fire-rated separations, smoke-tight boundaries, means of egress, exit enclosures, and vertical openings are maintained to the highest level possible.

34-1.2.3.1 The phasing plan must ensure that obstruction of the means of egress is avoided or minimized.

34-1.2.3.2 If exits are obstructed during construction, provide alternate means of egress and exit routes during each phase of construction and identify the alternate routes on the construction drawings as part of the phasing plan(s).

34-1.2.4 Minimize, to the extent possible, any impairments or disruptions to active fire protection features. Delineate phasing of construction to ensure that installations of new features (or systems) or modifications to existing ones are expedited.

34-1.2.4.1 Where possible, maintain existing systems in service until the replacement work has been deemed operational.

34-1.2.5 Prior to taking any actions to impair a fire protection feature or disrupt its performance, ensure alternative procedures have been prepared and incorporated and confirm that official notification of system impairments and schedules have been given to the staff of the *Facility*.

34-1.2.6 \2\See paragraph "Automatic Sprinkler Systems" in the "Fire Protection Systems" Chapter of this UFC for additional requirements./2/

34-1.2.7 \5\Where the Building Rehabilitation chapter of NFPA 101 requires newly constructed elements, components, and systems to comply with new construction requirements in the Code, then it shall also comply with new construction requirements in this UFC.

34-1.2.8 Floor plan reconfigurations that exceed 50 percent of the area of a floor require that the entire floor be brought up to the requirements for new construction in this UFC and NFPA 101. The means of egress serving this floor, including portions not located on this floor, must conform to the requirements for new construction in this UFC and NFPA 101. The notification appliances for the fire alarm and mass notification system must be upgraded throughout the remainder of the building as required to provide a uniform notification strategy. Floor plan reconfigurations that bring the building more into compliance with NFPA 101 shall not count towards the 50 percent floor area threshold.

[C] 34-1.2.8

The intent of upgrading fire alarm and mass notification devices throughout the remainder of the building is to provide a uniform notification strategy. For example, a facility may have existing clear and amber strobes throughout with no textural signs. The new requirement may be only clear strobes with textural signs. The floor being brought up to new UFC and new NFPA 101, and means of egress serving this floor, will require clear strobes and textural signs installed per the new criteria. The remainder of the floors will be modified so there are only clear strobes and textural signs, and the work shall not make these other floors less conforming to the UFC and NFPA 101.

34-1.2.9 If the project cost exceeds 50 percent of the building replacement value, then the entire building must be brought up to the requirements for new construction. Project costs to bring the building more into compliance with NFPA 101 shall not count towards the 50 percent threshold.

[C] 34-1.2.9

The intent of meeting requirements for new construction in this UFC is that this also applies to any requirements in applicable UFC 4-series, unless the UFC 4-series states otherwise.

34-1.2.10 Dimensional criteria for existing stairs in NFPA 101 for height of risers, tread depth, headroom, and height between landings is acceptable in lieu of meeting the requirements for new construction. The minimum headroom for existing buildings per NFPA 101 is acceptable in lieu of meeting the requirements for new construction.

[C] 34-1.2.10

If feasible, the new dimensions in NFPA 101 for height of risers, tread depth, headroom, and height between landings should be followed. Any reconstruction should involve the entire stair so there is no change in these dimensions when descending from the highest level. However, the intent of allowing use of the existing stair criteria in NFPA 101 for riser height, tread depth, headroom, and height between landings is to avoid very expensive or even unfeasible structural modifications to the facility. Utilities such as HVAC and lighting are not a reason to follow headroom requirements for existing buildings in NFPA 101 in lieu of the requirements for new.

34-1.3 /5/Change in Use.

34-1.3.1 When a change in use occurs, the area of the change, and its associated means of egress, must comply with the requirements for new construction.

34-1.3.1.1 When any building with an occupant load of less than 11, or portion thereof, is changed from its current use of a building with an occupant load greater than 10, personnel housing and similar lodging facilities, or assembly occupancy /5/ for one year or more, the building must meet the requirements for new construction.

[C] 34-1.3.1.1

Examples would include: a warehouse (occupant load less than 11) being changed to administrative use with an occupant load greater than 10; an administrative use with an occupant load of less than 11 being changed to an assembly occupancy or personnel housing and similar lodging facilities; an assembly occupancy being changed to personnel housing and similar lodging facilities, or vice versa.

34-1.3.1.2 When any building, or portion thereof, is changed from its current use to support a mission that will exist for one year or more, the building must meet the requirements for new construction.

[C] 34-1.3.1.2

An example would include a *Facility* used as a hangar that is going to be changed to a warehouse.

34-1.3.1.3 Changing groups of occupants within the occupancy classification does not constitute a change of use; however, any deficiencies must be corrected prior to the new occupants occupying the space.

[C] 34-1.3.1.3

An example of changing groups of occupants would include an *Installation Personnel* function occupying the office space formerly used by an *Installation Contracting* function.

34-1.3.2 When a change in use results in a higher occupant load that exceeds the existing egress capacity, the *Facility* must meet the requirements for new construction as specified in this UFC.

34-1.4 Vacant Buildings.

34-1.4.1 When a vacant building is considered for reuse, the building must be evaluated for the occupancy that is planned to be in the building and all deficiencies must be corrected prior to occupancy. This includes a building to be reused for the same occupancy, i.e., last use was a warehouse and the new use will be a warehouse.

34-1.4.2 The vacant building must be evaluated to the requirements for new construction in this UFC and NFPA 101.

34-2 PHASED PROJECTS.

34-2.1 General.

Projects or programs involving floor plan reconfiguration that will encompass more than 50 percent of the area of a floor, or project or program costs exceeding 50 percent of the building replacement value, that are planned in a phased approach or have separate projects to improve various parts of the facility must conform to the requirements of new construction as stated above

34-2.1.1.1 These requirements are not applicable if the time from the start of design of the first phase to the start of design of the phase involving floor plan reconfiguration

that exceeds 50 percent of the area, or project cost exceeds 50 percent of the building replacement value, is greater than five years.

34-3 COOKING AREAS.

Cooking equipment in common areas in existing, non-sprinklered *Facilities* that are provided with residential type range top cooking surfaces must be equipped with an approved residential range top extinguishing system or the stoves must be equipped with burners and controls that have their temperature limited to a maximum temperature of 662 degrees F (350 degrees C). The range top extinguishing system must be connected to the *Facility* fire alarm system to sound a general *Facility* fire alarm and must automatically shut off all sources of fuel and electric power that produce heat to the equipment being protected by that unit.

34-4 DETENTION AND CORRECTIONAL FACILITIES.

Navy facilities must also comply with MIL HDBK 1037/4.

34-5 ELECTRONIC EQUIPMENT AREAS.

For existing facilities that contain non-plenum rated cables under the raised floor and do not have an automatic fire extinguishing system under the raised floor must provide a clean agent fire extinguishing system for the area below the raised floor.

34-6 FAMILY HOUSING.

34-6.1 Projects that exceed 50 percent of the Replacement Cost.

34-6.1.1 1-hour fire-resistive construction must be provided between *Dwelling Units*, and between the *Dwelling Unit* and attached parking.

34-6.1.2 Sprinkler protection must be provided throughout the *Facility*, designed and installed in accordance with NFPA 13, NFPA 13R, or NFPA 13D as applicable.

34-6.1.3 Multiple-station, interconnected, hard-wired, 120 Vac smoke detectors must be provided inside each sleeping room and at least one on each floor, including basements.

34-6.1.4 Air Force allows interconnected wireless smoke alarms for use in single-family and duplex housing.

34-6.2 Projects that are less than 50 percent of the Replacement Cost.

34-6.2.1 Multiple-station, interconnected, hard-wired, 120 Vac smoke detectors must be provided inside each sleeping room and at least one on each floor, including basements. Air Force allows interconnected wireless smoke alarms for use in single-family and duplex housing.

34-6.2.2 Sprinkler protection must be considered for installation in the *Facility*.

34-7 FIRE PROTECTION SYSTEMS.

34-7.1 General.

See the paragraphs entitled "Fire Suppression Systems" and "Automatic Sprinkler Systems" in the "Fire Protection Systems" Chapter in this UFC for requirements related to backflow prevention devices.

34-8 FIRE ALARM SYSTEMS.

34-8.1 General.

34-8.1.1 When the existing control panel is replaced, it must be replaced with a new addressable control panel.

34-8.1.1.1 Existing devices are permitted to remain when listed for use with the new control panel or they are interfaced via listed monitor modules or control modules.

34-8.1.1.2 Battery calculations must be submitted to verify the power supply provided is capable of supporting the electrical load of the new and existing devices.

34-8.1.2 Where a new control panel is provided as part of a partial *Facility* rehabilitation, the renovated areas must comply with the requirements of this section. The existing circuits in the non-renovated areas of the *Facility* are permitted to be connected to the new fire alarm control panel via monitor modules or control modules.

34-9 HAZARDOUS MATERIALS.

Existing storage and use of flammable and combustible liquids must comply with NFPA 30.

Existing storage and use of other hazardous materials must comply with NFPA 400.

34-10 PERSONNEL HOUSING.

34-10.1 Common Areas.

Cooking areas in existing, non-sprinklered *Facilities* that are provided with residential type range top cooking surfaces must be equipped with an approved residential range top extinguishing system or the stoves must be equipped with burners and controls that have their temperature limited to a maximum temperature of 662 degrees F (350 degrees C). The range top extinguishing system must be connected to the *Facility* fire alarm system, if provided, to sound a general *Facility* fire alarm and must automatically shut off all sources of fuel and electric power that produce heat to the equipment being protected by that unit.

34-10.2 Air Force.

Existing Air Force non-sprinklered *Facilities* with the following features are considered acceptable until protection is compliant with the "Personnel Housing and Similar Lodging Facilities" section of this UFC is provided: Heat and smoke detection installed in each sleeping room and the shared/common space of a suite. Activation of the heat detector must sound a general building alarm and transmit a signal to the fire department or to a constantly monitored central location. Activation of the smoke detector must sound a local alarm within the room/suite. The smoke detector is permitted to be powered from an unsupervised 120 Vac source. The use of battery backup for secondary power is not required./5/

34-11 ROOF COVERINGS.

For re-roofing existing nonconforming metal roof decks, roofing components (insulation, underlayment, etc.) must be specified as having a maximum flame spread rating of 75 and a maximum smoke-development rating of 150 in accordance with ASTM E84.

This Page Intentionally Left Blank

APPENDIX A REFERENCES

AMERICAN CORRECTIONAL ASSOCIATION (ACA)

<http://www.aca.org/>

Planning and Design Guide for Secure Adult and Juvenile Facilities

AMERICAN NATIONAL STANDARDS INSTITUTE (ANSI)

<http://www.ansi.org>

ANSI B1.20.1, Pipe Thread

ANSI/IEEE 979, Guide for Substation Fire Protection

AMERICAN WATER WORKS ASSOCIATION (AWWA)

<http://www.awwa.org>

AWWA Manual M 14, Recommended Practice for Backflow Prevention and Cross Connection Control

AWWA Manual M 17, Installation, Field Testing and Maintenance of Fire Hydrants

AWWA Manual M 31, Distribution System Requirements for Fire Protection

ASME INTERNATIONAL

<http://www.asme.org/>

ASME A17.1, Safety Code for Elevators and Escalators

AMERICAN SOCIETY FOR TESTING AND MATERIALS (ASTM)

<http://www.astm.org>

ASTM A351, Standard Specification for Casting, Austenitic for Pressure-Containing Parts

ASTM E84, Standard Method of Test of Surface Burning Characteristics of Building Materials

ASTM E119, Standard Test Methods for Fire Tests of Building Construction and Materials

ASTM E136, Standard Test Method for Behavior of Materials in a Vertical Tube Furnace at 750°C

ASTM E814, Standard Test Method for Fire Tests of Penetration Firestop Systems

DEPARTMENT OF DEFENSE, WASHINGTON HEADQUARTERS SERVICE

<http://www.dtic.mil/whs/directives/>

\3\DESR 6055.09, Defense Explosives Safety Regulation/3/

DEPARTMENT OF THE AIR FORCE

<http://www.e-publishing.af.mil/>

AFMAN 91-201, Explosives Safety Standard

AFTO 00-25-172, Ground Servicing of Aircraft and Static Grounding/Bonding

ETL 01-18, Fire Protection Engineering Criteria- Electronic Equipment Installations

AFI 32-1054, Corrosion Control

DEPARTMENT OF THE ARMY

385-100, Safety Manual

AR 385-64, Explosives Safety Program

EM-385-1-1, Safety and Health Requirements Manual

U.S. Army National Guard NGR 385-64, U.S. Army Ammunition and Explosives Safety Standards

AR 420-90, Facilities Engineering Fire and Emergency Services

DEPARTMENT OF DEFENSE

[MIL-STD-3007](#), Standard Practice for Unified Facilities Criteria and Unified Facilities Guide Specifications

DoDI 4165.56, Relocatable Buildings

DEPARTMENT OF THE NAVY

MIL-F-24385F, Fire Extinguishing Agent, Aqueous Film-Forming Foam (AFFF) Liquid Concentrate, for Fresh and Seawater

NAVSEA OP-5, Ammunition and Explosives Ashore Safety Regulations for Handling, Storing, Production, Renovation, and Shipping

OPNAVINST 11010.33, Procurement, Lease and Use of Relocatable Buildings

NAVAIR 00-80R-14, NATOPS Aircraft Firefighting and Rescue Manual

NAVAIR 00-80T-109, Aircraft Refueling NATOPS Manual

SS 521-AA-MAN-010, U.S. Navy, Diving and Manned Hyperbaric Systems Safety Certification Manual

EXECUTIVE ORDER

Executive Order 13728, Wildland-Urban Interface Federal Risk Mitigation of 18 May 2016/3/

FACTORY MUTUAL GLOBAL (FM)

<http://www.fmglobal.com/>

FM Global Data Sheet 1-20, Protection Against Exterior Fire Exposure

FM Global Data Sheet 1-53, Anechoic Chambers

FM Global Data Sheet 5-4, Transformers

FM Global Data Sheet 7-91, Hydrogen

FM Global Data Sheet 8-33, Carousel Storage and Retrieval Systems

FM Global Data Sheet 8-34, Automatic Storage and Retrieval Systems

INTERNATIONAL CODE COUNCIL (ICC)

<http://www.iccsafe.org>

IBC, International Building Code®

IFC, International Fire Code®

IRC, International Residential Code®

IWUIC, International Wildland-Urban Interface Code®

NATIONAL FIRE PROTECTION ASSOCIATION (NFPA)

www.nfpa.org

NFPA 1, Fire Code

NFPA 10, Standard for Portable Fire Extinguishers

NFPA 11, Standard for Low-, Medium-, and High-Expansion Foam

NFPA 12, Standard on Carbon Dioxide Extinguishing Systems

NFPA 13, Standard for the Installation of Sprinkler Systems

NFPA 13R, Standard for the Installation of Sprinkler Systems in Low-Rise Residential Occupancies

NFPA 13D, Standard for the Installation of Sprinkler Systems in One- and Two-Family Dwellings and Manufactured Homes

NFPA 14, Standard for the Installation of Standpipe and Hose Systems

NFPA 15, Standard for Water Spray Fixed Systems for Fire Protection

NFPA 16, Standard for the Installation of Foam-Water Sprinkler and Foam-Water Spray Systems

NFPA 17, Standard for Dry Chemical Extinguishing Systems

NFPA 17A, Standard for Wet Chemical Extinguishing Systems

NFPA 20, Standard for the Installation of Stationary Pumps for Fire Protection

NFPA 22, Standard for Water Tanks for Private Fire Protection

NFPA 24, Standard for the Installation of Private Fire Service Mains and Their Appurtenances

NFPA 30, Flammable and Combustible Liquids Code

NFPA 30A, Code for Motor Fuel Dispensing Facilities and Repair Garages

NFPA 37, Standard for the Installation and Use of Stationary Combustion Engines and Gas Turbines

NFPA 45, Standard on Fire Protection for Laboratories Using Chemicals

NFPA 51, Standard for the Design and Installation of Oxygen-Fuel Gas Systems for Welding, Cutting, and Allied Processes

NFPA 52, Vehicular Gaseous Fuel Systems Code

NFPA 54, National Fuel Gas Code

NFPA 55, Compressed Gases and Cryogenic Fluids Code

NFPA 58, Liquefied Petroleum Gas Code

NFPA 70, National Electrical Code®

NFPA 72, National Fire Alarm and Signaling Code®

ANSI/NFPA 75, Standard for the Fire Protection of Information Technology Equipment

NFPA 76, Standard for the Fire Protection of Telecommunications Facilities

NFPA 80A, Recommended Practice for Protection of Buildings From Exterior Fire Exposures

NFPA 88A, Standard for Parking Structures

NFPA 90A, Standard for the Installation of Air-Conditioning and Ventilating Systems

NFPA 92, Standard for Smoke Control Systems

NFPA 96, Standard for Ventilation Control and Fire Protection of Commercial Cooking Operations

NFPA 99, Health Care Facilities Code

NFPA 99B, Standard for Hypobaric Facilities

NFPA 101, Life Safety Code®

NFPA 102, Standard for Grandstands, Folding and Telescopic Seating, Tents, and Membrane Structures

NFPA 170, Standard for Fire Safety and Emergency Symbols

NFPA 204, Standard for Smoke and Heat Venting

NFPA 220, Standard on Types of Building Construction

NFPA 241, Standard for Safeguarding Construction, Alteration, and Demolition Operations

NFPA 255, Standard Method of Test of Surface Burning Characteristics of Building Materials

NFPA 291, Recommended Practice for *Fire Flow* Testing and Marking of Hydrants

NFPA 303, Fire Protection Standard for Marinas and Boatyards

NFPA 307, Standard for the Construction and Fire Protection of Marine Terminals, Piers, and Wharves

NFPA 312, Standard for Fire Protection of Vessels During Construction, Conversion, Repair, and Lay-Up

NFPA 400, Hazardous Materials Code

NFPA 409, Standard on Aircraft Hangars

NFPA 704, Standard System for the Identification of the Hazards of Materials for Emergency Response

NFPA 750, Standard on Water Mist Fire Protection Systems

NFPA 850, Recommended Practice for Fire Protection for Electric Generating Plants and High Voltage Direct Current Converter Stations

NFPA 909, Protection of Cultural Resource Properties - Museums, Libraries, and Places of Worship

NFPA 1141, Standard for Fire Protection Infrastructure for Land Development in Wildland, Rural, and Suburban Areas

NFPA 1142, Standard on Water Supplies for Suburban and Rural Fire Fighting

NFPA 1144, Standard for Reducing Structural Ignition Hazards from Wildland Fire

NFPA 1221, Standard for the Installation, Maintenance, and Use of Emergency Services Communications Systems

NFPA 1963, Standard for Fire Hose Connections

NFPA 2001, Standard on Clean Agent Fire Extinguishing Systems

NFPA 5000, Building Construction and Safety Code®

SOCIETY OF AUTOMOTIVE ENGINEERS

<https://www.sae.org/>

SAE 1010, Steel Properties

SOCIETY OF FIRE PROTECTION ENGINEERS

<http://www.sfpe.org>

SFPE Engineering Guide to Performance-Based Fire Protection Analysis and Design of Buildings

UNDERWRITERS LABORATORY (UL)

<http://www.ul.com/>

UL 864, Standard for Control Units and Accessories for Fire Alarm Systems

UL 1283, Electromagnetic Interference Filters

UL 1449, Surge Protective Devices

UL 1479, Fire Tests of Through-Penetration Firestops.

UNIFIED FACILITIES CRITERIA (UFC) AND FACILITIES CRITERIA (FC)

http://www.wbdg.org/references/pa_dod.php

FC 4-740-14N, Navy and Marine Corps Child Development Centers

FC 4-760-10N, Navy Museums and Historic Resource Facilities

UFC 1-200-01, General Building Requirements

UFC 3-230-01, Water Storage, Distribution, and Transmission

UFC 3-400-02, Design: Engineering Weather Data

UFC 3-460-01, Design: Petroleum Fuel Facilities

UFC 3-520-01, Interior Electrical Systems

UFC 3-570-02A, Cathodic Protection

UFC 3-570-02N, Electrical Engineering Cathodic Protection

UFC 3-570-06, O&M: Cathodic Protection Systems

UFC 4-010-01, DoD Minimum Antiterrorism Standards for Buildings

UFC 4-020-01, DoD Security Engineering Facilities Planning Manual

UFC 4-021-01, Design and O&M: Mass Notification Systems

UFC 4-150-02, Dockside Utilities for Ship Service

UFC 4-151-10, General Criteria for Waterfront Construction

UFC 4-152-01, Design: Piers and Wharves

UFC 4-159-01N, Design: Hyperbaric Facilities

UFC 4-211-01N, Aircraft Maintenance Hangars, Type I, Type II, and Type III

UFC 4-211-02, Aircraft Corrosion Control and Paint Facilities

UFC 4-213-10, Design: Graving Drydocks

UFC 4-213-12, Drydocking Facilities Characteristics

UFC 4-451-10N, Design: Hazardous Waste Storage

UFC 4-510-01, Design: Medical Military Facilities

UFC 4-740-06, Youth Centers

UFC 4-740-14, Design: Child Development Centers

UNITED STATES ACCESS BOARD

<http://www.access-board.gov/>

ABA/ABAAG, Architectural Barriers Act and Architectural Barriers Act Accessibility Guidelines

UNITED STATES DEPARTMENT OF LABOR, OCCUPATIONAL SAFETY AND HEALTH ADMINISTRATION (OSHA)

<http://www.ecfr.gov/cgi-bin/text-idx?tpl=%2Findex.tpl>

29 CFR 1910.109, Explosives and Blasting Agents

UNITED STATES HOUSE OF REPRESENTATIVES, OFFICE OF THE LAW REVISION COUNSEL

<http://uscode.house.gov/>

USC Title 10, Chapter 8, Subchapter II, Military Child Care

USC Title 15, Section 272, Utilization of Consensus Technical Standards by Federal Agencies

USC Title 15, Section 2225, Hotel-Motel Fire Safety

USC Title 15, Section 2227, Fire Administration Authorization Act ("Fire Safety Act")

USC Title 42, Section 4151 Architectural Barriers Act Of 1968

This Page Intentionally Left Blank

APPENDIX B OCCUPANCY HAZARD CLASSIFICATION FOR DETERMINING AUTOMATIC SPRINKLER DENSITIES AND HOSE STREAM DEMANDS

B-1 CLASSIFICATION OF OCCUPANCIES.

The principal occupancy classifications are light hazard, ordinary hazard, and extra hazard. Listed below are the classifications with examples of common DoD occupancies listed under each. Where an occupancy is not listed, the applicable NFPA standard must be used, along with engineering judgment, to determine the appropriate occupancy hazard classification.

B-1.1 Light Hazard Occupancies.

Occupancies or portions of occupancies where the quantity and combustibility of the contents are low and fires with relatively low rates of heat release are expected. Small, scattered amounts of flammable liquids in closed containers are allowable in quantities not exceeding 5 gal (20 L) per *Fire Area*. This classification includes but is not limited to the following occupancies:

- Clinics (dental, outpatient, patient areas only)
- Mess areas
- Dispensaries (patient areas only)
- Drill halls (not used for storage or exhibition)
- Disciplinary barracks
- Child Development Centers

B-1.2 Ordinary Hazard Occupancies.

Occupancies or portion of occupancies where quantity and combustibility of contents is moderate, storage does not exceed 12 feet (3.7 m), and fires with moderate rate of heat release are expected. Moderate, scattered amounts of flammable liquids in closed containers are allowable in quantities not to exceed 50 gal (189 L) per *Fire Area*. Small amounts of flammable liquids may be exposed as required by normal operations. This classification includes but is not limited to the following occupancies:

- Armories
- Sheet metal shops
- Bowling alleys
- Ship fitting shops
- Clubs (officer, enlisted personnel, etc.)
- Kitchens and bakery

- Small stores
- Fitness Centers
- Gymnasiums
- Theaters and auditoriums
- Welding shops
- Forge shops
- Laundries
- Mechanical rooms, with or without boilers or fuel-fired equipment
- Electrical rooms, other than transformer vaults
- Small storage rooms
- Commissaires
- Exchanges
- Aviation depots
- Electrical maintenance shops
- Engine and generator rooms
- Laboratories
- Refrigeration and air compressor rooms
- Machine rooms
- Printing shops (using inks having flash points above 110°F (44°C))
- Libraries
- Piers and wharves
- Vehicle repair garages
- Woodworking shops

B-1.3 Extra Hazard Occupancies.

DoD occupancies, that might be classified as extra hazard, are often addressed by unique occupancy specific criteria/guidance rather than being addressed generically as extra hazard.

B-1.4 Special Occupancies.

Special occupancies are *Facilities* or areas that DoD does not assigned a specific occupancy hazard classification because of special protection requirements. Refer to Chapter 4 for fire protection requirements for the following occupancies:

- Flammable and combustible liquids
- Aircraft hangars
- Engine test cells
- Missile assembly
- Ordnance plants
- Rubber tire storage
- Warehouses (piled or rack storage)
- Foam rubber or plastic storage

APPENDIX C PROCEDURE FOR PERFORMANCE-BASED FIRE SAFETY DESIGN

C-1 EQUIVALENT LEVEL OF SAFETY AND PROTECTION.

Any proposed performance-based fire safety design must demonstrate, to the satisfaction of the *AHJ*, a level of safety equivalent to the minimum applicable prescriptive requirements of this UFC.

C-2 FIRE SAFETY DESIGN DOCUMENTATION.

Any *Facility* designed using performance-based fire safety design methods must have supporting documentation, including a Fire Protection Engineering Design Brief, Performance-Based Design Report, Specification, Drawings, Building Operation & Maintenance Manuals, and Warrant of Fitness.

C-2.1 Fire Protection Engineering Design Brief.

This is a separate document from the project \4\ Fire Protection Design Analysis/4/, prepared by the *QFPE* and containing general qualitative project information that has been agreed upon by the *Stakeholders*. As a minimum, the design brief includes the project scope, *Facility* and occupant characteristics, project goals and objectives, performance criteria, design fire scenarios, technical references and resources, at least two trial designs, documentation of project design engineers and their qualifications, and a record of agreement on the aforementioned components.

C-2.1.1 Project Scope.

This section describes the boundaries of the performance-based design as agreed upon by all *Stakeholders*, and includes realistic and sustainable design information regarding *Facility* use, design purpose and approach, project constraints, and applicable regulations. The project budget must be clearly defined, so that the limitations and available budget for the proposed solutions can be known.

C-2.1.2 Facility and Occupant Characteristics.

Facility characteristics include an accurate and complete description of the *Facility* construction, operations, systems, physical contents and occupants. Occupant characteristic description includes the number, age, *Facility* familiarity, gender, occupant loading, and potential for self-preservation of a *Facility's* occupants. Accurately identify any necessary occupant response and interaction needed to provide hazard mitigation or securing of specific process or operational equipment. The occupant load is the maximum number of people realistically expected to occupy an area, as agreed upon by the *Stakeholders*, but not less than the prescriptive occupant load densities of NFPA 101.

C-2.1.3 Goals.

Detail and document the goals of life safety, property protection, continuity of operations, and the limitation of the environmental impact of the fire, as defined by NFPA 101, and as additionally defined by the *Stakeholders*. Adequately address the allied fire safety goals of historic preservation and environmental protection from fire protection measures. Identify each goal - realistically, quantifiably, and remaining constant throughout the design process. Address each goal by each proposed trial design, regardless of the goal's individual importance.

C-2.1.4 Objectives and Acceptable Levels of Risk.

Clearly identify *Stakeholder* and design objectives associated with each of the required and user-defined goals.

C-2.1.4.1 *Stakeholder* objectives are the specific project objectives based upon agreed fire safety goals and must be stated in terms of objectives, functional statements, or performance objectives. *Stakeholders'* objectives may be defined in terms of acceptable or sustainable loss or in terms of an acceptable level of risk. Where a design requires the determination of an acceptable level of risk, the *AHJ* must ensure that the appropriate *Stakeholders* make the determination. The level of risk may affect an entire base/community/command; therefore it is essential to ensure the persons determining the level of risk are authorized to do so.

C-2.1.4.2 Design objectives are developed by the design engineer based on the *Stakeholder* objectives, and are stated in engineering terms. Use design objectives as the basis for the development of performance criteria, against which the predicted performance of a trial design will be evaluated.

C-2.1.5 Performance Criteria.

Develop quantitative performance criteria to represent the intent of each design objective and retained prescriptive requirement. Completely describe and document these criteria. The performance criteria reflect the event consequences that need to be avoided to fulfill the design objectives, and include realistic values that are capable of being evaluated or measured using existing engineering tools and methods.

C-2.1.5.1 The performance criteria must be a combination of the life safety and property protection criterion, along with criteria developed from *Stakeholder* objectives.

Note: NFPA 101 and the SFPE Engineering Guide to Performance-Based Fire Protection Analysis and Design of Buildings provide guidance regarding the development and evaluation of appropriate performance criteria.

C-2.1.6 Design Fire Scenarios.

Document complete descriptions of the reasoning, intent, and details of all required and *Stakeholder* defined fire scenarios. Use realistic and accurate fire scenarios, with respect to all fire elements, including initial fire location, early rate of growth in fire

severity, and smoke generation. Indicate in the description of the fire scenarios all applicable data, characteristics and assumptions, which must remain consistent between all fire scenarios. Ensure the omission of certain details will not reduce the reality of the proposed design fire scenario. The *QFPE* must justify any design fire scenario data that is omitted or cannot be considered by available evaluation methods, and this justification must be noted and approved by the *AHJ*.

C-2.1.7 Technical References and Resources.

Thoroughly document all technical references, including methodologies, data and sources. Identify the scientific basis of each engineering calculation method or model. Develop, review and validate these methods using a consensus, peer-review process, or obtain from resource publications. Where the chosen methods do not permit the incorporation of all data or do not accurately address the incorporation of the data, perform a sensitivity analysis for any design, performance criteria, or fire scenario data that cannot be included or used in the chosen methods. Address all degrees of conservatism and factors of safety, and clearly identify the limitations of the calculation methods. Any method whose outcome is significantly altered by the omission of trial design or fire scenario details must not be approved, and the omission of critical data is prohibited. The use of proprietary and non-peer reviewed data or source is not permitted. The *AHJ* must approve the assessment methods, data, and sources, and confirm the validity of all technical references and resources prior to the design evaluation. Provide the technical reviewer, upon request, any technical references or resources.

C-2.1.7.1 The performance criteria must be capable of being proved or measured using existing engineering tools and methods.

C-2.1.8 Trial Designs.

Identify and document the general details, including the proposed construction, systems, and protection methods. Include in the documentation the safety factors associated with each trial design, as agreed upon by the *Stakeholders*. Clearly identify the impact of the safety factors so that a reasonable decision can be made as to whether their level is appropriate and sufficient. State any retained prescriptive requirements. Where the interaction of emergency response personnel is a designed protection method, accurately identify and confirm the impact and responsibility of the emergency personnel.

The performance criteria must be equally considered and addressed by each trial design against each fire scenario.

Evaluate each trial design in each fire scenario using the agreed upon performance criteria.

C-2.1.9 Project Team and Qualifications.

Provide the qualifications and contact information for the entire design team, including the *QFPE* as part of the required documentation. A performance-based, fire safety design must be prepared by a *QFPE* with experience in performance-based fire safety design and specific experience with the engineering tools and methodologies that are anticipated for a particular project.

C-2.2 Performance-Based Fire Safety Design Report.

This documentation must be prepared by the *QFPE*, and used for general guidance. The report must indicate that the *Facility* was designed using a performance-based fire safety design approach, and must convey the expected hazards, risks, and system performance over the entire *Facility* life-cycle. Include the project scope, design goals and objectives, performance criteria, design fire scenarios, critical design assumptions, critical design features, final design, cost benefit analysis, design engineer's qualifications and capabilities, and data and evaluation method references.

C-2.2.1 Cost Benefit.

The performance-based fire safety design report must indicate how the performance-based design maximizes the benefits/cost ratio while maintaining a level of safety equivalent to the established prescriptive requirements. A performance-based design must not be undertaken where the prescriptive requirements provide the same level of safety for a lesser cost. Where multiple acceptable proposed design scenarios exist, the cost benefit analysis must aid in the identification and determination of the best solution.

C-2.3 Building O&M Documentation.

The *QFPE* must produce Building Operation and Maintenance documentation for the facility based on the objectives, performance criteria, limitations, and final design. Include all associated specifications and design drawings, and a description of the required maintenance procedures that need to be performed to ensure continued compliance with performance-based fire safety design.

C-2.4 Warrant of Fitness.

The host-tenant agreement must require that an annual Warrant of Fitness be prepared for any subsystem, system, or *Facility* that has been designed using performance-based fire safety design methods. Submit this warrant to the *AHJ* for review and assurance that the current facility characteristics comply with the requirements of the approved performance design. This warrant must reflect any existing or proposed changes in *Facility* occupancy, operation, features, systems, or emergency personnel response. Where emergency response is a critical element in the accepted fire safety design, reevaluate the design when changes are made to the operational procedures, location, or structure of the emergency response personnel.

C-3 REVIEW OF TRIAL DESIGNS.

Provide every performance-based fire safety design with a technical review, and develop a Review Brief. Analyze each trial design to determine the compliance with the required performance criteria. The reviewer must be an individual capable of providing a thorough evaluation of the proposed design, and must have the same minimum qualifications as the *QFPE*. If the authority responsible for the review of the performance-based fire safety design does not have the required qualifications, they must direct the designer to submit the design to a qualified third party for review.

C-3.1 Review Brief.

The Review Brief details how each proposed design compares with the required fire safety goals, objectives and performance criteria. The Brief provides a brief description of the details of each trial design, the technical resources and references, any concerns about steps in the design process and general concerns about the designer's performance-based fire safety design approach. The Brief indicates the acceptability of each design, the reasoning for each acceptance or rejection, and which design is recommended for final acceptance. It must also discuss levels of confidence over validation. The Brief must indicate how personnel and property protection are considered, which objectives the design stresses, a statement of what has been checked, the design solution, and the entire design approach and process.

C-3.2 Third Party Review.

When required, an assigned third party must provide an objective review of the project, and must not provide the actual fire safety design. When a third party is reviewing the design, the *AHJ* remains a *Stakeholder* and ultimately is responsible for the approval of the final design. When a review is assigned to a third party, provide the *AHJ* with a Review Brief.

C-3.3 Compliant Fire Safety Design.

A compliant fire safety design must meet the stated performance criteria when subjected to each design fire scenario. A subsystem, system or *Facility* design that complies with all requirements of the applicable prescriptive criteria is deemed as satisfying the minimum fire safety goals and objectives, and does not need to be evaluated against the design fire scenarios. Completely evaluate a performance-based fire safety design that incorporates only portions of applicable prescriptive criteria, as it is not considered to provide the minimum levels of protection.

Where a design does not meet the performance criteria, it may be revised and reevaluated. The revision must not reduce any agreed upon goals, objectives, performance criteria, or level of performance to ensure a proposed design complies with the stated requirements. Criteria may be changed based on additional analysis and the consideration of additional data.

This Page Intentionally Left Blank

APPENDIX D INTERNATIONAL BUILDING CODE AND NFPA 220 EQUIVALENTS

This table provides the corresponding types of construction from the various codes.
This table is for information only.

IBC	NFPA 220
	Type I (442)
Type I-A	Type I (332)
Type I-B	Type II (222)
Type II-A	Type II (111)
Type II-B	Type II (000)
Type III-A	Type III (211)
Type III-B	Type III (200)
Type IV (HT)	Type IV (2HH)
Type V-A	Type V (111)
Type V-B	Type V (000)

This Page Intentionally Left Blank

APPENDIX E RECOMMENDED FIRE ALARM AND EMERGENCY NOTIFICATION MESSAGES

GENERAL ANNOUNCEMENTS AND PAGING

AUDIBLE in the following sequence:

Pre-announcement Sound – Ding-Dong – Percussive pairs of 700 and 570 Hz tones each damped to zero (one cycle)

Announcement – spoken message.

VISIBLE none

FIRE EMERGENCY / FIRE ALARM {GENERIC} MESSAGES:

AUDIBLE [Audible must sound for not less than 180 seconds (NFPA 72)] in the following sequence:

Alert Sound – NFPA Temporal 3 (T-3) - 422-775Hz upward sweep over 850 ms for three-pulses each separated by 1 second followed by a 1.5 second delay (repeat 2 cycles)

Announcement: Voice – Tom (repeat 2 cycles):

Option 1: *A FIRE EMERGENCY HAS OCCURRED; PLEASE LEAVE THE BUILDING BY THE NEAREST EXIT.*

Option 2: *A FIRE EMERGENCY HAS OCCURRED; PLEASE LEAVE THE BUILDING BY THE NEAREST EXIT AND REPORT TO YOUR ASSEMBLY LOCATION*

Option 1E: *A FIRE EMERGENCY HAS OCCURRED; PLEASE LEAVE THE BUILDING BY THE NEAREST EXIT DO NOT USE THE ELEVATORS.*

Option 2E: *A FIRE EMERGENCY HAS OCCURRED; PLEASE LEAVE THE BUILDING BY THE NEAREST EXIT; DO NOT USE THE ELEVATORS AND REPORT TO YOUR ASSEMBLY LOCATION*

VISIBLE [Visible must flash/operate until system is reset]:

\5\CLEAR /5/ Strobe or other listed \5\CLEAR /5/ appliance.

Textual message signs (if provided).

CARBON MONOXIDE DETECTION {GENERIC} MESSAGES:

AUDIBLE [Audible must sound for not less than 180 seconds (NFPA 72)] in the following sequence:

Alert Sound – Temporal 4 (T-4) pattern tone - 520Hz over 850 ms for four-pulses each separated by 1 second followed by a 1.5 second delay (repeat 2 cycles)

Announcement: Voice – Tom (repeat 2 cycles):

Option 1: *CARBON MONOXIDE HAS BEEN DETECTED IN THE BUILDING; PLEASE LEAVE THE BUILDING BY THE NEAREST EXIT.*

Option 2: *CARBON MONOXIDE HAS BEEN DETECTED IN THE BUILDING; PLEASE LEAVE THE BUILDING BY THE NEAREST EXIT AND REPORT TO YOUR ASSEMBLY LOCATION*

VISIBLE [Visible must flash/operate until system is reset]:

\5\CLEAR /5/ Strobe or other listed \5\clear /5/ appliance.

Textual message signs (if provided).

Note: The Security / Force Protection messages are only shown as examples if prerecorded messages are desired. Security / Force Protection situations are a variety of circumstances and having a prerecorded message or a variety of messages that will satisfy all conditions will be very difficult and may provide inaccurate information for the situation at hand. Give careful consideration in determining if Security / Force Protection prerecorded messages are going to be used.

SECURITY / FORCE PROTECTION THREATS {GENERIC} MESSAGES

SHELTER IN PLACE:

AUDIBLE [Audible must sound for not less than 180 seconds] in the following sequence:

Alert Sound – Siren - 600-1250 hz up and down sweep in 4 seconds; 1.5 second delay (repeat 2 cycles)

Announcement: Voice – Tom (repeat 2 cycles):

Option 1: A [force protection emergency] [] HAS BEEN DECLARED; PLEASE TAKE SHELTER IN A DESIGNATED SAFE AREA IMMEDIATELY.

Option 2: A [force protection emergency] [] HAS BEEN DECLARED; PLEASE SEEK A DESIGNATED SAFE LOCATION IMMEDIATELY.

Option 1E: A [force protection emergency] [] HAS BEEN DECLARED; PLEASE TAKE SHELTER IN A DESIGNATED SAFE AREA IMMEDIATELY; DO NOT USE THE ELEVATORS.

VISIBLE [Visible must flash/operate until system is reset]:

\5\CLEAR /5/ Strobe or other listed \5\clear /5/ appliance.

Textual message signs (if provided).

EVACUATE:

AUDIBLE [Audible must sound for not less than 180 seconds] in the following sequence:

Alert Sound – Hi-Lo - 780 to 600 hz alternately, 0.52 each (repeat 2 cycles)

Announcement: Voice – Tom (repeat 2 cycles):

Option 1: A [force protection emergency] [] HAS BEEN DECLARED;; PLEASE LEAVE THE BUILDING BY THE NEAREST EXIT.

Option 2: A [force protection emergency] [] HAS BEEN DECLARED; PLEASE LEAVE THE BUILDING BY THE NEAREST EXIT AND REPORT TO YOUR ASSEMBLY LOCATION

Option 1E: A [force protection emergency] [] HAS BEEN DECLARED; PLEASE LEAVE THE BUILDING BY THE NEAREST EXIT DO NOT USE THE ELEVATORS.

Option 2E: A [force protection emergency] [] HAS BEEN DECLARED; PLEASE LEAVE THE BUILDING BY THE NEAREST EXIT; DO NOT USE THE ELEVATORS AND REPORT TO YOUR ASSEMBLY LOCATION

VISIBLE [Visible must flash/operate until system is reset]:

\5\CLEAR /5/ Strobe or other listed \5\clear /5/ appliance.

Textual message signs (if provided).

Note: The Weather / Natural Disaster Warnings (Tornado, Tsunami, Hurricane, Earthquake, Volcano, Etc.) messages are only shown as examples if prerecorded messages are desired. Weather / Natural Disaster situations will come in a variety of circumstances and having a prerecorded message or a variety of messages that will satisfy all conditions will be very difficult and may provide inaccurate information for the situation at hand. Give careful consideration in determining if Weather / Natural Disaster Warning prerecorded messages are going to be used.

WEATHER / NATURAL DISASTER WARNING(S) (TORNADO, TSUNAMI, HURRICANE, EARTHQUAKE, VOLCANO, ETC.) {GENERIC} MESSAGES

AUDIBLE - [Audible must continue to sound for not less than 180 seconds] in the following sequence:

Alert Sound – NOAA Standard alert tone - 1050 hz (8 seconds)

Announcement: Voice – Donna (repeat 2 cycles) (Systems may have multiple weather/natural disaster warning messages depending on the individual installation requirements and potential weather threats):

SHELTER IN PLACE:

Option 1: A [weather] [] EMERGENCY HAS BEEN DECLARED; PLEASE TAKE SHELTER IN A DESIGNATED SAFE AREA IMMEDIATELY.

Option 2: A [weather] [] EMERGENCY HAS BEEN DECLARED; PLEASE SEEK A DESIGNATED SAFE LOCATION IMMEDIATELY.

Option 1E: A [weather] [] EMERGENCY HAS BEEN DECLARED; PLEASE TAKE SHELTER IN A DESIGNATED SAFE AREA IMMEDIATELY; DO NOT USE THE ELEVATORS.

Option 2E: A [weather] [] EMERGENCY HAS BEEN DECLARED; PLEASE SEEK A DESIGNATED SAFE LOCATION IMMEDIATELY; DO NOT USE THE ELEVATORS.

EVACUATE:

Option 1: A [earthquake] [] EMERGENCY HAS OCCURRED;
PLEASE LEAVE THE BUILDING BY THE NEAREST EXIT.

Option 2: A [earthquake] [] EMERGENCY HAS OCCURRED;
PLEASE LEAVE THE BUILDING BY THE NEAREST EXIT AND
REPORT TO YOUR ASSEMBLY LOCATION.

Option 1E: A [earthquake] [] EMERGENCY HAS
OCCURRED; PLEASE LEAVE THE BUILDING BY THE NEAREST
EXIT; DO NOT USE THE ELEVATORS.

Option 2E: A [earthquake] [] EMERGENCY HAS
OCCURRED; PLEASE LEAVE THE BUILDING BY THE NEAREST
EXIT AND REPORT TO YOUR ASSEMBLY LOCATION; DO NOT
USE THE ELEVATORS.

VISIBLE [Visible must flash/operate until system is reset]:

\5\CLEAR /5/ strobe or other listed appliance.

Textual message signs (if provided).

ALL CLEAR RETURN TO NORMAL OPERATIONS MESSAGES

AUDIBLE in the following sequence:

Pre-announcement Sound – Ding-Dong – Percussive pairs of 700 and 570 Hz tones each damped to zero (one cycle)

Announcement: Voice – Donna (*repeat two cycles*) – THE EMERGENCY HAS BEEN RESOLVED; RETURN TO NORMAL OPERATIONS

VISIBLE none

AUTOMATED MONTHLY TEST MESSAGES

SCHEDULE the first Wednesday of each month at 1200 hours local.

AUDIBLE in the following sequence:

Pre-TEST Sound – NOAA Standard alert tone - 1050 hz (8 seconds)

Announcement: Voice – Tom – TEST, TEST, TEST, THIS IS AN EMERGENCY NOTIFICATION AUDIO SYSTEM TEST; *YOU MAY CONTINUE NORMAL OPERATIONS, TEST, TEST, TEST.*

VISIBLE [Visible must flash/operate during the pre-test sound and the announcement and then stop]:

\5\CLEAR /5/ Strobe or other listed appliance.

Textual message signs (if provided).

SPECIAL OCCUPANCIES

FIRE EMERGENCY / FIRE ALARM {Child Development Centers and Medical Facilities including Ambulatory} MESSAGES:

AUDIBLE [Audible must sound for not less than 180 seconds] in the following sequence:

Alert Sound – Three Pulse Chime - 575Hz, three-0.5 second pulses separated by 0.5 seconds followed by a 1.5 second delay (repeat 3 cycles)

Announcement: Voice – Donna (repeat 2 cycles):

*For outside assembly. A FIRE EMERGENCY HAS OCCURRED;
PLEASE LEAVE THE BUILDING BY THE NEAREST EXIT AND REPORT
TO THE ASSEMBLY LOCATION*

*For those Centers with horizontal exiting: A FIRE EMERGENCY HAS
OCCURRED IN THIS PART OF THE BUILDING; PLEASE MOVE TO
THE [define area] SAFE AREA.*

VISIBLE [Visible must flash/operate until system is reset]:

\5\CLEAR /5/ Strobe or other listed \5\CLEAR /5/ appliance.

Textual message signs (if provided).

CARBON MONOXIDE DETECTION: {Child Development Centers and Medical Facilities including Ambulatory} MESSAGES:

AUDIBLE [Audible must sound for not less than 180 seconds] in the following sequence:

Alert Sound – Four Pulse Chime - 575Hz, four-0.5 second pulses separated by 0.5 seconds followed by a 1.5 second delay (repeat cycles)

Announcement: Voice – Donna (repeat 2 cycles):

For outside assembly: CARBON MONOXIDE HAS BEEN DETECTED IN THE BUILDING; PLEASE LEAVE THE BUILDING BY THE NEAREST EXIT AND REPORT TO THE ASSEMBLY LOCATION

For those Centers with horizontal exiting: CARBON MONOXIDE HAS BEEN DETECTED IN THIS PART OF THE BUILDING; PLEASE MOVE TO THE [define area] SAFE AREA.

VISIBLE [Visible must flash/operate until system is reset]:

\5\CLEAR /5/ Strobe or other listed \5\clear /5/ appliance.

Textual message signs (if provided).

SECURITY / FORCE PROTECTION THREATS MESSAGES (Child Development Center and Medical Facilities including Ambulatory)

SHELTER IN PLACE:

AUDIBLE [Audible must sound for not less than 180 seconds] in the following sequence:

Alert Sound – Chime – Percussive 700 Hz chime tone for 10 seconds (one cycle)

Announcement: Voice – Donna (repeat 2 cycles):

Option 1: *A [force protection emergency] [] HAS BEEN DECLARED; PLEASE TAKE SHELTER IN A DESIGNATED SAFE AREA IMMEDIATELY.*

Option 2: *A [force protection emergency] [] HAS BEEN DECLARED; PLEASE SEEK A DESIGNATED SAFE LOCATION IMMEDIATELY.*

Option 1E: *A [force protection emergency] [] HAS BEEN DECLARED; PLEASE TAKE SHELTER IN A DESIGNATED SAFE AREA IMMEDIATELY; DO NOT USE THE ELEVATORS.*

VISIBLE [Visible must flash/operate until system is reset]:

\5\CLEAR /5/ Strobe or other listed \5\CLEAR /5/ appliance.

Textual message signs (if provided).

EVACUATE:

AUDIBLE [Audible must sound for not less than 180 seconds] in the following sequence:

Alert Sound – Chime – Percussive 700 Hz chime tone for 10 seconds (one cycle)

Announcement: Voice – Donna (repeat 2 cycles):

Option 1: A [force protection emergency] []
EMERGENCY HAS OCCURRED; PLEASE LEAVE THE BUILDING BY THE NEAREST EXIT.

Option 2: A [force protection emergency] [] HAS BEEN
DECLARED; PLEASE LEAVE THE BUILDING BY THE NEAREST EXIT AND REPORT TO YOUR ASSEMBLY LOCATION

Option 1E: A [force protection emergency] [] HAS
BEEN DECLARED; PLEASE LEAVE THE BUILDING BY THE NEAREST EXIT DO NOT USE THE ELEVATORS.

Option 2E: A [force protection emergency] [] HAS
BEEN DECLARED; PLEASE LEAVE THE BUILDING BY THE NEAREST EXIT; DO NOT USE THE ELEVATORS AND REPORT TO YOUR ASSEMBLY LOCATION

VISIBLE [Visible must flash/operate until system is reset]:

\5\CLEAR /5/ Strobe or other listed \5\CLEAR /5/ appliance.

Textual message signs (if provided).

FIRE EMERGENCY / FIRE ALARM {Aircraft Hangar} MESSAGES:

AUDIBLE [Audible must sound for not less than 180 seconds] in the following sequence:

Alert Sound – NFPA Temporal Whoop - 422-775Hz upward sweep over 850 ms for three-pulses separated by 1 second followed by a 1.5 second delay (repeat 2 cycles)

Announcement: Voice – Tom (repeat 2 cycles):

ACTIVATION FROM SUPPRESSION SYSTEM, MANUAL FIRE ALARM STATION, OR DETECTION (if provided) IN THE AIRCRAFT SERVICING AREA

Option 1: *A FIRE EMERGENCY HAS OCCURRED IN THE AIRCRAFT SERVICING AREA; PLEASE LEAVE THE BUILDING BY THE NEAREST EXIT. DO NOT EXIT THROUGH THE AIRCRAFT SERVICING AREA.*

Option 2: *A FIRE EMERGENCY HAS OCCURRED IN THE AIRCRAFT SERVICING AREA; PLEASE LEAVE THE BUILDING BY THE NEAREST EXIT AND REPORT TO YOUR ASSEMBLY LOCATION. DO NOT EXIT THROUGH THE AIRCRAFT SERVICING AREA.*

Option 1E: *A FIRE EMERGENCY HAS OCCURRED IN THE AIRCRAFT SERVICING AREA; PLEASE LEAVE THE BUILDING BY THE NEAREST EXIT DO NOT USE THE ELEVATORS. DO NOT EXIT THROUGH THE AIRCRAFT SERVICING AREA.*

Option 2E: *A FIRE EMERGENCY HAS OCCURRED IN THE AIRCRAFT SERVICING AREA; PLEASE LEAVE THE BUILDING BY THE NEAREST EXIT; DO NOT USE THE ELEVATORS AND REPORT TO YOUR ASSEMBLY LOCATION. DO NOT EXIT THROUGH THE AIRCRAFT SERVICING AREA.*

ACTIVATION FROM SUPPRESSION SYSTEM, MANUAL FIRE ALARM STATION OR DETECTION (if provided) IN THE ADJACENT SUPPORT AREA

Option 1: *A FIRE EMERGENCY HAS OCCURRED; PLEASE LEAVE THE BUILDING BY THE NEAREST EXIT.*

Option 2: *A FIRE EMERGENCY HAS OCCURRED; PLEASE LEAVE THE BUILDING BY THE NEAREST EXIT AND REPORT TO YOUR ASSEMBLY LOCATION*

Option 1E: *A FIRE EMERGENCY HAS OCCURRED; PLEASE LEAVE THE BUILDING BY THE NEAREST EXIT DO NOT USE THE ELEVATORS.*

Option 2E: *A FIRE EMERGENCY HAS OCCURRED; PLEASE LEAVE THE BUILDING BY THE NEAREST EXIT; DO NOT USE THE ELEVATORS AND REPORT TO YOUR ASSEMBLY LOCATION*

VISIBLE [Visible must flash/operate until system is reset]:

\5\Clear /5/ Strobe or other listed \5\clear /5/ appliance.

Textual message signs (if provided).

Messages will be generated by the text- to-speech system Speechify, Nuance, 2005 as used by NOAA for weather information and Emergency Alert System (EAS) messaging. The voices used will be “Tom” and “Donna” as identified for each message type. The current Nuance text-to-speech product is *Vocalizer 5.0*, Nuance, 2013.

NFPA 72 sound pressure levels applies to “public mode” notification devices “Alert Sound – NFPA Temporal Whoop - 422-775Hz upward sweep over 850 ms for three-pulses separated by 1 second followed by a 1.5 second delay”. Sound levels are measured:

- a. Maximum level at 10 feet horizontally perpendicular to the notification appliance at 5.5 feet above the finish floor.
- b. Minimum levels at no closer than ten feet from walls and other vertical obstructions at 5.5 feet above the finish floor.

NFPA 72 sound pressure levels apply to “private mode” fire alarm notification device as required in NFPA 72.

NFPA 72 sound pressure levels do not apply to other notification devices.

NFPA 72 voice intelligibility applies to all voice messages. Intelligibility measurements are not required in large open areas such as industrial work areas, warehouses, and aircraft servicing areas, garages, and similar facilities.

APPENDIX F ABBREVIATIONS AND ACRONYMS

°F	degrees Fahrenheit
°C	degrees Celsius
A&E	Architectural and Engineering Services
ABA	Architectural Barriers Act
ABAAG	Architectural Barriers Act Accessibility Guidelines
ACA	American Correctional Association
ADP	Automatic Data Processing
AFCEC	Air Force Civil Engineer Center
AFFF	Aqueous Film-Forming Foam
AFMAN	Air Force Manual
AFTO	Air Force Technical Order
AHJ	Authority Having Jurisdiction
ANSI	American National Standards Institute
AR	Army Regulation
ASCE	American Society of Civil Engineers
ASME	American Society of Mechanical Engineers
ASTM	American Society for Testing and Materials
ATFP	Anti-Terrorism Force Protection
AWG	American Wire Gauge
AWWA	American Water Works Association
BIA	Bilateral Infrastructure Agreement
CAD	Computer Aided Drafting
CDC	Child Development Center

cm ²	square centimeter(s)
CO	Carbon Monoxide
CO ₂	Carbon Dioxide
CRAC	Computer Room Air Conditioning
CSS	Central Security Service
DFPE	Designated Fire Protection Engineer
DLA	Defense Logistics Agency
DoD	Department of Defense
DoDI	Department of Defense Instruction
DPDT	Double-Pole, Double-Throw
ECB	Engineering Construction Bulletins
EM	Engineering Manual
EMCS	Energy Monitoring and Control System
ESFR	Early Suppression Fast-Response Sprinklers
ETL	Engineering Technical Letters
FAAA	Fire Administration Authorization Act
FACP	Fire Alarm Control Panel
FC	Facilities Criteria
FM	Factory Mutual Global
FPE	Fire Protection Engineer
FRT	Fire Retardant Treated Plywood
FS	Flame Spread Rating
ft	feet; foot
ft ²	square feet; square foot
gal	gallon(s)

GH ₂	Gaseous hydrogen
GOX	Gaseous Oxygen
gpm	gallons per minute
HQUSACE	Headquarters, U.S. Army Corps of Engineers
HNFA	Host Nation Funded Construction Agreements
HP	Horsepower
HVAC	Heating, Ventilating and Air Conditioning
HVLS	High Volume Low Speed
HZ	Hertz
IBC	International Building Code
ICC	International Code Council
IEEE	Institute of Electrical and Electronics Engineers
IFC	International Fire Code
in	inch(es)
in ²	square inch(es)
IRC	International Residential Code\2\
/2/kPa	kilopascal
L	liter(s)
LCD	Liquid Crystal Display
LEC	Electroluminescence
LED	Light Emitting Diode
LH ₂	Liquid Hydrogen
LOX	Liquid Oxygen
m	meter(s)
m ²	square meter(s)

MAF	Missile Alert Facilities
MIL-HDBK	Military Handbook
min	minute
mm	millimeter(s)
ms	milliseconds
NARA	National Archives and Records Administration
NATOPS	Naval Air Training & Operating Procedures Standardization
NAVAIR	Naval Air Systems Command
NAVFAC	Naval Facilities Engineering Command
NAVSEA	Naval Sea Systems Command
NCEES	National Council of Examiners for Engineering & Surveying
NFPA	National Fire Protection Association
NGA	National Geospatial-Intelligence Agency
NGR	National Guard Regulation
NPSH	Net Positive Suction Head
NRO	National Reconnaissance Office
NRTL	Nationally Recognized Testing Laboratory (as defined on the OSHA website https://www.osha.gov/dts/otpca/nrtl/nrtllist.html)
NSA	National Security Agency
OHES	Office of Occupational Health, Environmental & Safety Services
OPNAVINST	Naval Operations Instructions
P.E.	Registered Professional Engineer
PIV	Post Indicator Valve
POL	Petroleum Oil Lubricant
PRVs	Pressure-Regulating Valves

psi	pounds per square inch
PV	Photovoltaic
QFPE	Qualified Fire Protection Engineer
RPA	Remotely Piloted Aircraft
s	second(s)
SAE	Society of Automotive Engineers
SD	Smoke Developed Rating
SFPE	Society of Fire Protection Engineers
SOFA	Status of Forces Agreements
SPD	Surge protection device
UAS	Unmanned Aerial System/2/
UAV	Unmanned Aerial Vehicle
UFAS	Uniform Federal Accessibility Standard
UFC	Unified Facilities Criteria
UL	Underwriters Laboratories Inc.
USC	United States Code
Vac	volts alternating current
Vdc	volts direct current
WHS	Washington Headquarters Services

This Page Intentionally Left Blank

APPENDIX G \3\ CRITERIA FOR PROJECTS IN JAPAN

Purpose: The intent of this Appendix is to provide clarification on the use of Japanese products and standards. Japanese products and standards should be used to the maximum extent possible providing it does not change the intended level of life safety and fire protection specified in this UFC. Example: It is acceptable to use Japanese emergency public address system in lieu of a NRTL listed mass notification system; however, for sprinkler protection of various facilities, the paragraph “Design Requirements” in the “Fire Protection Systems” chapter of this UFC will be followed (see below for more specific requirements pertaining to these systems). The DFPE can make project level decisions based on the intent of this Appendix.

G-1 **GENERAL.** This appendix provides guidance on the specifically negotiated equivalencies/alternatives for all construction and facility maintenance in Japan in achieving the intended fire and life safety performance for DoD missions and personnel in accordance with this UFC.

G-1.1 DFPE. A DFPE is an individual who is a registered professional engineer (P.E.) who has passed the fire protection engineering written examination administered by the National Council of Examiners for Engineering and Surveying (NCEES) and has a minimum of five (5) years of relevant fire protection engineering experience. Where this section states DFPE, it means the DFPE as defined in this section, and it also includes an authorized representative deemed qualified by the DFPE.

G-1.2 Applicability. The requirements of this Appendix apply to all Host Nation Funded and Constructed DoD projects in Japan.

G-1.2.1 Japanese standards, materials, and installation practices will be used to achieve the criteria policy requirements of this UFC to the maximum extent practical and as modified below.

G-1.2.2 When the Japanese market place cannot accommodate a UFC required feature, means will be provided to achieve that requirement. Example, Japanese fire alarm standards do not provide for visual notifications and products do not exist in the market place, however, Japanese fire alarm equipment can power NRTL listed visual notification devices. Solution is to install NRTL listed visual devices powered by the Japanese equipment.

G-1.2.3 When Japanese standards do not mandate a feature normally required by this UFC such as circuit supervision, means will be identified to ensure Japanese optional features are included as mandatory requirements in Host-Nation projects. Example, UFC requires circuit supervision, certain types of Japanese control panels offer optional circuit supervision. Solution is to limit control panel choices to those panels offering optional circuit supervision.

G-1.3 Criteria Evaluations.

G-1.3.1 DFPE will coordinate with the Host Nation to evaluate and determine acceptable fire protection engineering policy, criteria, codes, manufactured equipment and materials to meet the intent of this UFC. If the DFPE is unable to successfully negotiate suitable alternatives, the DFPE will coordinate and obtain approval from the DoD Fire Protection Engineering Working Group (FPEWG).

G-1.3.2 The DFPE will submit coordinated alternatives to the FPEWG for inclusion in this Appendix.

G-1.4 Products, Standards, and Installation Methods Evaluations.

G-1.4.1 The DFPE will coordinate with the Host Nation to determine acceptable Japanese materials, equipment and installations standards meeting the intent of this UFC.

G-1.4.2 DoD service DFPE for Japan will share any approvals/disapprovals with the other services and the DOD FPEWG.

G-1.5 Host Nation Design Process.

G-1.5.1 Criteria and concept packages including the development of the Life Safety and Building Code plans and analysis, architectural floor plans and the fire protection design analysis, in English, will be under the review and oversight of a QFPE and reviewed and approved by the DFPE. The packages will comply with NFPA 101, Life Safety Code, and the International Building Code (IBC), as referenced and modified by this UFC. A fire protection design analysis meeting the section "Fire Protection Design Analysis and Life Safety Plans" will be included in the packages.

G-1.5.2 Design drawings, plans, and specifications are developed by Host Nation qualified engineers and architects. DFPE reviews the drawings, plans, and specifications to ensure compliance with this UFC.

G-1.5.3 During the construction and acceptance process, the DFPE will review shop drawings with identified changes from the design drawings to ensure compliance with criteria. The DFPE will provide construction inspection support when needed or requested. The DFPE will witness final acceptance testing of all fire protection systems.

G-1.6 Host-Nation Requirements.

G-1.6.1 Host Nation requirements in excess of this UFC do not require approval by the AHJ.

G-1.6.2 The QFPE services is limited to the criteria and concept package submittal stages only. The process identified in paragraph "Applicability" in this Appendix will meet the QFPE requirements during the construction and acceptance stages.

G-1.6.3 The code compliance certification is not required to address compliance with host-Nation Codes and standards. The QFPE will review the criteria and concept package drawings and document in writing that the package is in compliance with the this UFC and all applicable fire protection and life safety design criteria. A Host Nation fire protection consultant is not required

G-1.6.4 For conflicts between this UFC and the Host-Nation fire protection criteria, the DFPE will be consulted.

G-1.6.5 Fire protection features installed to exclusively comply with Japanese fire protection requirements are not required to be documented in the fire protection design analysis.

G-1.6.6 Identifying code/criteria conflicts and DFPE approved design solutions to meet the requirements of the UFC will be documented in the fire protection design analysis.

G-1.6.7 Shop drawing prepared in accordance with the Japanese Building Standards and Fire Service Law and reviewed in accordance with this Appendix meet the intent of this UFC. NICET preparation of the shop drawings and QFPE reviews are not required.

G-1.7 Acceptance Testing. Inspections, evaluations, and approvals required under the Japanese Fire Service Act should be conducted jointly by the local Japanese Fire Authority and the cognizant DoD activity. Failure of the DoD authority to participate will not limit the Japanese Fire Authority from executing the requirements of the Japanese Fire Service Act.

G-1.7.1 Japanese authorities, generally, only evaluate the features required by Japanese law (The Building Standard Act and the Fire Service Act). DoD will normally accept the Japanese determination the Japanese required features are acceptable/unacceptable.

G-1.7.2 It is DoD's responsibility to evaluate all additional DoD requirements and their appropriate interface with the Japanese required features ensuring a complete and usable facility system.

G-2 AIRCRAFT HANGARS.

G-2.1 General. Use the requirements of UFC 4-211-01, Aircraft Maintenance Hangars.

G-2.2 Optical Detectors and Releasing Controls. Comply with paragraphs "Releasing Service Fire Alarm Control Unit (RSFACU)" and "Optical Flame Detection" in Chapter "Air Force Specific Criteria" in UFC 4-211-01, and paragraph "Releasing Service Fire Alarm Control Unit (RSFACU)" in Chapter "Navy Specific Criteria" in UFC 4-211-01.

G-2.3 Floor Grate Nozzles and Flow Control Valves. Comply with paragraph "AFFF Trench Nozzle System" in Chapter "General Hangar Requirements" in UFC 4-211-01.

G-2.4 Other Components. Japanese materials and installation practices are acceptable.

G-3 ELEVATORS

G-3.1 Doors. The use of a 60 minute elevator door is acceptable regardless of the required fire rating of the shaft.

G-3.2 Fire Service Operations. Fire service emergency operations Phase I and Phase II in accordance with ASME A17.1 are required on all elevators.

G-3.3 Shaft and Machine Room. Elevator shaft and machine room will be fire rated in accordance with NFPA 101 with the exception of the elevator doors and machine room doors. These doors are allowed to be 60 minute fire doors regardless of the required fire rating of the shaft or machine room.

G-4 FIRE ALARMS AND MASS NOTIFICATION.

G-4.1 General. Install fire alarm systems where required by this UFC, including referenced codes and standards as modified by this UFC.

G-4.2 Control Panels.

G-4.2.1 Fire Alarm and Notification. Japanese traditional Type P1 control panels and Japanese addressable Type R are permitted to be used when traditional or addressable type panels are required by this UFC. Type R will be used when an emergency communication system is provided.

G-4.2.1.1 All the Japanese optional features for supervision of devices and circuits are required regardless of which panel is used.

G-4.2.1.2 Detection devices, manual pull stations, supervisory devices will be provided where required by this UFC.

G-4.2.1.3 Visual notification appliances are required. Listed devices by a NRTL will be used and located in accordance with the distribution requirements of NFPA 72.

G-4.2.1.4 Audible notification devices are required. Japanese devices will be used and located in accordance with installation standards referenced in this UFC.

G-4.3 Mass Notification.

G-4.3.1 Japanese emergency public address systems will be used to provide mass notification. This meets the intent of UFC 4-021-01.

G-4.3.2 All available Japanese optional features for supervision of speakers and circuits are required when used on DoD installation in Japan.

G-4.3.3 Provide audible notification devices in all areas and rooms when the audible requirements of NFPA 72 cannot be met.

G-4.3.4 Mass notification system are recommended to be used for general paging.

G-4.3.5 Voice intelligibility may be assessed by the manual method and approved by the DFPE.

G-5 FIRE DOORS.

G-5.1 General. Fire doors of an equal or greater fire resistance will be provided where fire doors are required by this UFC.

G-5.1.1 Latching. All fire doors must be able to latch in the closed position.

G-5.1.2 Use of a Japanese design specification 20- and 60-minute fire door is permitted. Doors shall be labeled as required by Japanese standards. See Figures G-5.1.3.1 and G-5.1.3.2 for door label examples and locations.

G-5.1.3 Use of a Japanese tested and labeled 60-minute door is permitted.



Fig G-5.1.3.1 60 Minute Label



FIG G-5.1.3.2 Label Location

G-6 FIRE PUMPS.

G-6.1 Vertical Lift Fire Pumps. Fire pumps for vertical lift such as taking suction from a cistern as is found in many Japanese sprinkler and other fire protection systems will be Japanese vertical turbine type.

G-6.2 Supervision of Power for Electric Fire Pumps. The loss of power, reverse polarity, and pump running conditions must be monitored and a signal must be sent to a constantly attended location, normally the fire alarm receiving center.

G-7 WATER SUPPLY.

G-7.1 Water Supply for Sprinklers and Fire Protection Systems. When Japanese 20 minute cisterns are used, an automatic resupply connection will be provided meeting the design demand for not less than 40 minutes.

G-7.2.1 The Japanese 20-minute cistern is not considered a water storage tank. (Reference: 9-4)

G-8 SMOKE AND CARBON MONOXIDE ALARMS.

G-8.1 General. Install smoke and carbon monoxide alarms as required in this UFC.

G-9 SPRINKLERS.

G-9.1 General. Provide sprinkler protection when required by this UFC, including referenced codes and standards as modified by this UFC. Sprinklers protection will be designed in accordance with the Japanese technical requirements based on using Japanese equipment.

G-9.1.1 Japanese residential type sprinklers are permitted anywhere a NRTL type residential sprinkler is allowed to be used.

G-9.1.2 Japanese condominium style sprinklers are permitted in multi-story apartment applications.

G-9.2 Special Conditions. Situations where requirements do not exist in Japanese technical requirements, use technical requirements referenced in this UFC. The use of Japanese equipment is acceptable if such products exist in the Japanese market.

G-9.2.1 Ceiling Height Above 30 Feet (10m). Provide ceiling sprinklers. Design will be based on area and density requirements in the "Fire Protection Systems" chapter of this UFC.

G-9.2.2 Storage Above 12 Feet. Provide ceiling sprinklers. Design will be based on area and density methods in NFPA 13.

G-10 **REFERENCES**

G-10.1 Japanese Laws and Related Government Standards. The following Japanese documents are available in English translations:

G-10.1.1 The Building Standard Law of Japan, The Building Center of Japan, <http://www.bcj.or.jp/en/>

G-10.1.2 The Building Standards Law Enforcement Order, The Building Center of Japan, <http://www.bcj.or.jp/en/>

G-10.1.3 The Building Standards Law Enforcement Regulation, The Building Center of Japan, <http://www.bcj.or.jp/en/>

G-10.1.4 The Ministerial Order Concerning Designated Qualifying Examination Body and Others Based on the Building Standard Law, The Building Center of Japan, <http://www.bcj.or.jp/en/>

G-10.1.5 The Fire Service Law of Japan, http://www.kaigai-shobo.jp/pdf/Fire_Service_Act_eng.pdf

G-10.1.6 Ministerial Ordinance for Enforcement of the Fire Service Law, http://www.kaigai-shobo.jp/pdf/Ministerial_Ordinance_eng.pdf

G-10.1.7 Japanese Industrial Standards, Japanese Standards Association, <https://www.jsa.or.jp/en/ /3/>

UNIFIED FACILITIES CRITERIA (UFC)

DESIGN AND O&M: MASS NOTIFICATION SYSTEMS



APPROVED FOR PUBLIC RELEASE; DISTRIBUTION UNLIMITED

UNIFIED FACILITIES CRITERIA (UFC)

MASS NOTIFICATION SYSTEMS

Any copyrighted material included in this UFC is identified at its point of use. Use of the copyrighted material apart from this UFC must have the permission of the copyright holder.

AIR FORCE CIVIL ENGINEER SUPPORT AGENCY (Preparing Activity)

NAVAL FACILITIES ENGINEERING COMMAND

U.S. ARMY CORPS OF ENGINEERS

Record of Changes (changes are indicated by \1\.../1/).

Change No.	Date	Location
<u>1</u>	<u>January 2010</u>	<u>Revised paragraph 1-3.3; revised paragraph 2-4; revised Chapter 4; revised Chapter 5; revised glossary; revised Appendix A; revised paragraph B-1; and revised paragraph C-2.3</u>

This UFC supersedes UFC 4-021-01, dated 18 December 2002.

FOREWORD

The Unified Facilities Criteria (UFC) system is prescribed by MIL-STD 3007 and provides planning, design, construction, sustainment, restoration, and modernization criteria, and applies to the Military Departments, the Defense Agencies, and the DoD Field Activities in accordance with [USD\(AT&L\) Memorandum](#) dated 29 May 2002. UFC will be used for all DoD projects and work for other customers where appropriate. All construction outside of the United States is also governed by Status of Forces Agreements (SOFA), Host Nation Funded Construction Agreements (HNFA), and in some instances, Bilateral Infrastructure Agreements (BIA). Therefore, the acquisition team must ensure compliance with the more stringent of the UFC, the SOFA, the HNFA, and the BIA, as applicable.

UFC are living documents and will be periodically reviewed, updated, and made available to users as part of the Services' responsibility for providing technical criteria for military construction. Headquarters, U.S. Army Corps of Engineers (HQUSACE), Naval Facilities Engineering Command (NAVFAC), and Air Force Civil Engineer Support Agency (AFCESA) are responsible for administration of the UFC system. Defense agencies should contact the preparing service for document interpretation and improvements. Technical content of UFC is the responsibility of the cognizant DoD working group. Recommended changes with supporting rationale should be sent to the respective service proponent office by the following electronic form: [Criteria Change Request \(CCR\)](#). The form is also accessible from the Internet sites listed below.

UFC are effective upon issuance and are distributed only in electronic media from the following source:

- Whole Building Design Guide web site <http://dod.wbdg.org/>.

Hard copies of UFC printed from electronic media should be checked against the current electronic version prior to use to ensure that they are current.

AUTHORIZED BY:

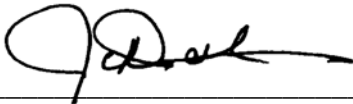

JAMES C. DALTON, P.E.
Chief, Engineering and Construction
U.S. Army Corps of Engineers



PAUL A. PARKER
The Deputy Civil Engineer
DCS/Logistics, Installations & Mission Support
Department of the Air Force



JOSEPH E. GOTT, P.E.
Chief Engineer and Director,
Capital Improvements, Acting
Naval Facilities Engineering Command

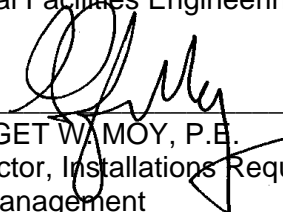

Dr. GET W. MOY, P.E.
Director, Installations Requirements and
Management
Office of the Deputy Under Secretary of Defense
(Installations and Environment)

**UNIFIED FACILITIES CRITERIA (UFC)
REVISION SUMMARY SHEET**

Document: UFC 4-021-01

Superseding: UFC 4-021-01, dated 18 December 2002

Description of Changes: This revision to UFC 4-021-01 incorporates new mass notification system (MNS) design requirements for the Air Force, Army, Marine Corps, and Navy. Design figures were changed accordingly. Criteria was added approving the use of combined MNS and fire alarm systems in some facilities. Chapters were added on wide area MNS, operational characteristics, and special considerations. Sample pre-recorded MNS messages were added in Appendix B. Progress towards incorporation of Internet capability into DOD mass notification is discussed in Appendix C.

Reasons for Changes:

- Incorporate lessons learned from field experience since the initial revision of this UFC in 2002.
- Achieve consistency with new national consensus standards for MNS.
- Incorporate Marine Corps MNS requirements into one consolidated manual.
- Comply with the new format for Security Engineering UFC series documents.

Impact: There are negligible cost impacts; however, these benefits should be realized:

- Simplify construction and avoid installation costs in many new and renovated facilities by permitting combined MNS and fire alarm systems.
- Simplify procurement of MNS equipment by requiring consistency with national consensus standards for MNS.
- Ensure future MNS will coordinate with the new national “public alert and warning system” required by Executive Order 13407 of 28 June 2006.

CONTENTS

	<u>Page</u>
CHAPTER 1: INTRODUCTION	1
1-1 BACKGROUND	1
1-2 PURPOSE	1
1-3 SCOPE	1
1-3.1 Applicability	1
1-3.2 Service Exception	1
1-3.3 Compliance with Technical Criteria	1
1-3.4 Authority having Jurisdiction (AHJ)	2
1-3.5 Waivers	2
1-3.6 Implementation	2
1-3.7 Responsibilities	2
1-3.8 Retroactivity	2
1-4 REFERENCES	3
1-5 QUALIFICATIONS OF SUPPLIERS AND CONTRACTORS	3
1-5.1 System Integrators and Contractors	3
1-5.2 Mass Notification System Component Products and Manufacturers	3
1-5.3 Performance and Acceptance Testing	3
1-5.4 Installation Records	3
1-6 SECURITY ENGINEERING UFC SERIES	3
1-6.1 DOD Minimum Antiterrorism Standards for Buildings	3
1-6.2 Security Engineering Facilities Planning Manual	4
1-6.3 Security Engineering Facilities Design Manual	4
1-6.4 Security Engineering Support Manuals	4
CHAPTER 2: OVERVIEW OF SYSTEMS	5
2-1 SCOPE	5
2-2 CAPABILITY	5
2-3 LIFE SAFETY SYSTEMS	5
2-4 ACCESSIBILITY	5
2-5 PUBLIC ALERT AND WARNING SYSTEM	5
2-6 SYSTEM TYPES	5
2-6.1 Wide Area MNS	5
2-6.2 Individual Building MNS	6
CHAPTER 3: WIDE AREA MNS	7
3-1 SCOPE	7
3-2 REQUIREMENTS FOR SYSTEM DESIGNERS	7
3-2.1 Designer Qualifications	7
3-2.2 System Integrators and Contractors	7
3-3 SYSTEM SIGNALS	7
3-3.1 Voice Signals	7
3-3.2 Music	8
3-3.3 Tones	8
3-4 SUBSYSTEMS	8

3-4.1	Central Control Stations.....	8
3-4.2	HPSA.....	8
3-4.3	Communications Links.....	8
3-4.4	Ancillary Equipment.....	8
3-5	CENTRAL CONTROL STATIONS.....	8
3-5.1	Locations.....	8
3-5.2	On-Installation Control.....	9
3-5.3	Off-Installation Interfaces.....	9
3-5.4	Central Control Station Requirements.....	9
3-6	HPSA.....	12
3-6.1	Arrangement in Zones.....	12
3-6.2	Directional Characteristics.....	12
3-6.3	Outdoor Areas.....	12
3-6.4	Special Outdoor Areas (Army and Air Force Projects).....	13
3-6.5	Occupational Noise Exposure.....	14
3-6.6	Noise Pollution.....	14
3-6.7	HPSA Inside of Buildings.....	15
3-6.8	HPSA Speaker Sites.....	15
3-6.9	HPSA Performance.....	15
3-6.10	Temperature Rating.....	17
3-6.11	Battery Backup Power.....	17
3-6.12	Connection to Portable Electrical Power Generator.....	17
3-6.13	Elevated Supporting Structure.....	17
3-6.14	HPSA Attached to Buildings.....	18
3-7	COMMUNICATIONS LINKS.....	18
3-7.1	Primary Communications Link.....	18
3-7.2	Redundant Communications Link.....	19
3-7.3	Off-the-Shelf Equipment.....	19
3-7.4	Supervision.....	20
3-7.5	Diagnostics.....	20
3-7.6	Interfaces with Other Systems.....	20
CHAPTER 4: INDIVIDUAL BUILDING MNS FOR NEW CONSTRUCTION PROJECTS		
.....		21
4-1	SCOPE.....	21
4-2	REQUIREMENTS FOR SYSTEM DESIGNERS.....	21
4-3	SYSTEM OVERVIEW.....	21
4-3.1	Subsystems.....	21
4-3.2	ACU.....	22
4-3.3	LOC.....	22
4-3.4	Notification Appliance Network.....	22
4-3.5	Interfaces with the Wide Area MNS.....	23
4-3.6	Logical Block Diagrams.....	23
4-4	ACU.....	26
4-4.1	Locations.....	26
4-4.2	Design Features.....	26
4-4.3	Off-the-Shelf Equipment.....	29

4-4.4	Programming Codes	29
4-4.5	Power Supply Features	29
4-5	LOC	29
4-5.1	Locations	29
4-5.2	Design Features	30
4-6	NOTIFICATION APPLIANCE NETWORK	31
4-6.1	Audible Appliance Network	31
4-6.2	Visual Appliance Network	34
4-7	INTERFACES WITH WIDE AREA MNS	35
CHAPTER 5: INDIVIDUAL BUILDING MNS FOR RENOVATION PROJECTS		37
5-1	SCOPE	37
5-2	REQUIREMENTS FOR SYSTEM DESIGNERS	37
5-3	USE OF NEW CONSTRUCTION CRITERIA	37
5-3.1	FACP Replacement: No Existing MNS in Building	37
5-3.2	FACP Replacement: Existing MNS in Building	37
5-3.3	MNS Installation Projects	38
5-4	SYSTEM OVERVIEW	38
5-4.1	Subsystems	38
5-4.2	ACU	38
5-4.3	LOC	38
5-4.4	Notification Appliance Network	38
5-4.5	Interfaces with Facility FACP	39
5-4.6	Interfaces with Facility PA System	40
5-4.7	Interfaces with the Wide Area MNS	40
5-4.8	Logical Block Diagrams	41
5-5	ACU	49
5-5.1	Location	49
5-5.2	Design Features	49
5-5.3	Off-the-Shelf Equipment	52
5-5.4	Programming Codes	52
5-5.5	Power Supply Features	52
5-6	LOC	52
5-6.1	Locations	52
5-6.2	Design Features	53
5-7	NOTIFICATION APPLIANCE NETWORK	54
5-7.1	Audible Appliance Network	54
5-7.2	Visual Appliance Network	57
5-8	INTERFACES WITH WIDE AREA MNS	58
CHAPTER 6: SPECIAL CONSIDERATIONS		59
6-1	OVERVIEW	59
6-2	IMPLEMENTATION PLAN	59
6-3	GIANT VOICE SYSTEM	59
6-4	TELEPHONE ALERTING SYSTEM	59
6-5	SPECIAL OCCUPANCIES	60
6-5.1	No Self-Preservation Capability	60
6-5.2	Not Occupied by Hearing Impaired Persons	60

6-5.3	Housing and Lodging Facilities	60
CHAPTER 7: OPERATIONAL CHARACTERISTICS		62
7-1	INTRODUCTION	62
7-2	WIDE AREA MNS.....	62
7-2.1	Central Control Stations.....	62
7-2.2	Regional or National Command Centers	62
7-2.3	Public Alert and Warning System	62
7-2.4	HPSA	62
7-2.5	Supplemental Mass Notification Delivery Systems	62
7-3	INDIVIDUAL BUILDING MNS	63
7-3.1	Combined Systems.....	63
7-3.2	LOC	63
7-3.3	ACU	63
7-3.4	Notification Appliances.....	63
CHAPTER 8: MAINTENANCE		65
8-1	INTRODUCTION	65
8-2	MAINTENANCE RESPONSIBILITIES	65
8-2.1	Air Force	65
8-2.2	Marine Corps	65
8-3	QUALIFICATIONS OF MAINTENANCE PERSONNEL	65
8-3.1	Inspection, Testing, and Maintenance Tasks.....	65
8-3.2	Other Inspections.....	66
8-3.3	Maintenance Records.....	66
8-4	INDIVIDUAL BUILDING MNS	66
8-5	WIDE AREA MNS.....	66
GLOSSARY		69
APPENDIX A	REFERENCES	73
APPENDIX B	SAMPLE PRE-RECORDED MNS MESSAGES	77
APPENDIX C	NET-CENTRIC ALERTING SYSTEMS	82

FIGURES

<u>Figure</u>	<u>Title</u>	
4-1	Individual Building Mass Notification System, Combination Fire Alarm System and MNS (Navy).....	24
4-2	Individual Building Mass Notification System, Combination Fire Alarm System and MNS (Army and Air Force).....	25
5-1	Individual Building Mass Notification System: Separate Fire Alarm System and MNS (Navy).....	42
5-2	Individual Building Mass Notification System: Separate Fire Alarm	

	System and MNS (Army and Air Force)	43
5-3	Individual Building Mass Notification System: Separate Fire Alarm System and MNS (Marine Corps)	44
5-4	Individual Building Mass Notification System: Speakers Shared by Fire Alarm System and MNS (Navy)	45
5-5	Individual Building Mass Notification System: Speakers Shared by Fire Alarm System and MNS (Army and Air Force).....	46
5-6	Use of Existing Public Address System: Navy	47
5-7	Use of Existing Public Address System: Army and Air Force.....	48

TABLES

<u>Table</u>	<u>Title</u>	
8-1	Central Control Unit Maintenance	66
8-2	Communications Network Maintenance	68

CHAPTER 1

INTRODUCTION

1-1 **BACKGROUND.** Mass notification provides real-time information and instructions to people in a building, area, site, or installation using intelligible voice communications along with visible signals, text, and graphics, and possibly including tactile or other communication methods. The purpose of mass notification is to protect life by indicating the existence of an emergency situation and instructing people of the necessary and appropriate response and action.

This Unified Facilities Criteria (UFC) was developed by collecting and refining criteria from Department of Defense (DOD) antiterrorism guidance, examining previous mass notification system (MNS) evaluation reports, and reviewing the capabilities of representative, commercially available MNS and products.

1-2 **PURPOSE.** This UFC provides technical criteria for systems that will:

- Implement mass notification in compliance with the DOD antiterrorism requirements as specified in UFC 4-010-01
- Implement national design standards and recommendations for mass notification systems as provided in National Fire Protection Association (NFPA) Standard 72 (including Annex E)
- Achieve coordination of DOD mass notification capabilities with national systems as required by Executive Order 13407

1-3 **SCOPE.** This UFC provides the design, operation, and maintenance requirements of MNS for DOD facilities. The requirement for a MNS is established by UFC 04-010-01. This document is intended to assist in the design of systems that meet the requirement established by UFC 04-010-01 and to give guidance to commanders, architects, engineers, and end users on design, operation, and maintenance of MNS.

1-3.1 **Applicability.** This UFC applies to new construction, major renovations, and leased buildings and must be used in accordance with the applicability requirements of UFC 4-010-01 or as directed by service guidance. See UFC 4-010-01 for more information on the applicability requirements.

1-3.2 **Service Exception.** Where one or more service's criteria vary from the other services' criteria, it is noted in the text with the **SE** (Service Exception) symbol.

1-3.3 **Compliance with Technical Criteria.** Do not deviate from the technical criteria of this UFC without prior approval from the component office of responsibility:

- U.S. Air Force: Air Force Civil Engineer Support Agency, \1\ Operations and

Programs Support Division /1/ (HQ AFCESA/CEO)

- U.S. Army: U.S. Army Corps of Engineers, Directorate of Civil Works, Engineering and Construction (HQ USACE/CECW-CE)
- U.S. Navy: Naval Facilities Engineering Command, Headquarters Chief Engineer's Office (NAVFACENCOM HQ Code CHE)
- U.S. Marine Corps (HQMC), Code PS and Code LFF-1
- Defense Logistics Agency Director (HQ DLA-D) through Support Services (DLA-DES-SE)
- National Geospatial-Intelligence Agency (NGA), Security and Installations
- Other DOD components: the Office of the Deputy Under Secretary of Defense (Installations & Environment) (DUSD [I&E]) via the DOD Committee on Fire Protection Engineering

1-3.4 **Authority having Jurisdiction (AHJ).** The component office of responsibility listed in paragraph 1-3.3 is also referred to in this UFC as the AHJ.

1-3.5 **Waivers and Exemptions.** The AHJ may approve waivers and exemptions to the technical criteria of this UFC only. Waivers and exemptions shall comply with the requirements of MIL-STD-3007, *Department of Defense Standard Practice for Unified Facilities Criteria and Unified Facilities Guide Specifications*.

1-3.6 **Implementation.** Implementation of an effective MNS will require the coordinated efforts of engineering, communications, and security personnel. Fire protection engineering personnel are needed for the successful implementation of this UFC because they bring a special expertise in life safety evaluations, building evacuation systems, and the design of public notification systems. Coordination with communications personnel is required when the MNS is connected to the DOD installation's communications infrastructure. The designated first responders of the DOD installation are ultimately responsible for the protection of building occupants, and will be the primary users of an individual building MNS. Designated security or command personnel will be the primary users of a wide area MNS and should recommend installation projects, oversee access control, update central control system mapping and, as necessary, develop associated local recipient groups for targeted notification.

1-3.7 **Responsibilities.** DOD does not mandate which organizations are responsible for funding, operation, or maintenance of MNS installed in accordance with UFC 4-010-01; each DOD component must assign those responsibilities.

1-3.8 **Retroactivity.** Existing MNS installed in compliance with an earlier version of this UFC do not have to be modified to meet the requirements of the current edition of this UFC; however, any alteration or any installation of new equipment shall meet, as nearly as practicable, the requirements for new MNS.

1-4 **REFERENCES.** See Appendix A.

1-5 **QUALIFICATIONS OF SUPPLIERS AND CONTRACTORS**

1-5.1 **System Integrators and Contractors.** Use system integrators and contractors that are able to demonstrate a full knowledge and understanding of systems used for mass notification, and that have factory-trained personnel to perform system design, installation, testing, training, and maintenance.

1-5.2 **MNS Component Products and Manufacturers.** Only accept products from manufacturers that can meet the design criteria of this UFC and can demonstrate 5 years of experience in producing products similar to those required for mass notification. Utilize products of current manufacture with replacement parts and components available for a minimum of ten years.

1-5.3 **Performance and Acceptance Testing**

1-5.3.1 Upon completion of the installation, the contractor must complete performance testing of the MNS for compliance with this UFC. Verification of performance testing will be checked by local representatives of the AHJ. Performance results, including the required sound pressure levels and intelligibility values, shall be documented and submitted to the AHJ with notation of any deficiencies and corrective actions.

Note: The AHJ are those component offices of responsibility listed in paragraph 1-3.3 (see paragraph 1-3.4).

1-5.3.2 Upon successful completion of performance testing, the contractor must complete a witnessed acceptance test. Acceptance testing will be witnessed by local representatives of the AHJ. (See paragraph 1-3.4 for more information on the AHJ.)

1-5.4 **Installation Records.** The contractor must provide a complete set of record drawings and operations and maintenance manuals for the MNS. Record drawings and operations and maintenance manuals must provide information for troubleshooting, preventive maintenance, and corrective maintenance.

1-6 **SECURITY ENGINEERING UFC SERIES.** This UFC is one of a series of security engineering UFC documents that cover minimum standards, planning, preliminary design, and detailed design for security and antiterrorism. The manuals in this series are designed to be used sequentially by a diverse audience to facilitate development of projects throughout the design cycle. The manuals in this series include:

1-6.1 **DOD Minimum Antiterrorism Standards for Buildings.** UFC 4-010-01 and 4-010-02 establish standards that provide minimum levels of protection against terrorist attacks for the occupants of all inhabited DOD buildings. These UFC are intended to be used by security and antiterrorism personnel and design teams to identify the minimum

requirements that must be incorporated into the design of all new construction and major renovations of inhabited DOD buildings. These UFC also include recommendations for designs that should be, but are not required to be, incorporated into all such buildings.

1-6.2 **Security Engineering Facilities Planning Manual.** UFC 4-020-01FA presents processes for developing the design criteria necessary to incorporate security and antiterrorism measures into DOD facilities and for identifying the cost implications of applying those design criteria. These design criteria may be limited to the requirements of the minimum standards, or they may include protection of assets other than those addressed in the minimum standards (people), aggressor tactics that are not addressed in the minimum standards, or levels of protection beyond those required by the minimum standards. The cost implications for security and antiterrorism are addressed as cost increases over conventional construction for common construction types. The changes in construction represented by those cost increases are tabulated for reference, but they represent only representative construction that will meet the requirements of the design criteria. The manual also addresses the tradeoffs between cost and risk. UFC 4-020-01FA is intended to be used by planners as well as security and antiterrorism personnel with support from planning team members.

1-6.3 **Security Engineering Facilities Design Manual.** UFC 4-020-02FA provides interdisciplinary design guidance for developing preliminary systems of protective measures to implement the design criteria established in UFC 4-020-01FA. Those protective measures include building and site elements, equipment, and the supporting manpower and procedures necessary to make them work as a system. The information in UFC 4-020-02FA is in sufficient detail to support concept-level project development, and as such can provide a good basis for a more detailed design. The manual also provides a process for assessing the impact of protective measures on risk. The primary audience for UFC 4-020-02FA is the design team, but the UFC can also be used by security and antiterrorism personnel.

1-6.4 **Security Engineering Support Manuals.** In addition to the standards, planning, and design UFC discussed in paragraphs 1-6.1 through 1-6.3, a series of additional UFC documents is planned that will provide detailed design guidance for developing final designs based on the preliminary designs developed using UFC 4-020-02FA. These support manuals will provide specialized, discipline-specific design guidance. Some will address specific tactics such as direct-fire weapons, forced entry, or airborne contamination. Others will address limited aspects of design such as resistance to progressive collapse or the design of portions of buildings such as mailrooms. Still others will address details of designs for specific protective measures such as vehicle barriers or fences. The security engineering support manuals are intended to be used by the design team during the development of final design packages.

CHAPTER 2

OVERVIEW OF SYSTEMS

2-1 **SCOPE.** This chapter includes important definitions and provides an overview of MNS.

2-2 **CAPABILITY.** Mass notification provides real-time information and instructions to people in a building, area, site, or DOD installation using intelligible voice communications along with visible signals, text, and graphics, and possibly including tactile or other communication methods. MNS are intended to protect life by indicating the existence of an emergency situation and instructing people of the necessary and appropriate response and action.

2-3 **LIFE SAFETY SYSTEMS.** MNS are designated as life safety systems in a manner similar to DOD-required fire protection systems.

2-4 **ACCESSIBILITY.** Compliance with \1\ Architectural Barriers Act Accessibility Guidelines (ABAAG) /1/ for MNS is required. Visual alarm notification appliances shall be provided inside of buildings for hearing impaired persons when new MNS are installed. Providing visual alarm notification appliances is required for DOD compliance with Executive Order 13347.

2-5 **PUBLIC ALERT AND WARNING SYSTEM.** Coordination of MNS with national alert and warning systems is required for DOD compliance with Executive Order 13407.

2-6 **SYSTEM TYPES**

Note: See Appendix C for a discussion of Internet-based alerting systems.

2-6.1 **Wide Area MNS.** Wide area MNS are installed to provide real-time information to outdoor areas of a DOD installation. These systems are normally provided with and operated from two or more central control stations. Communications between central control stations and individual building MNS is provided. Communications between the central control stations and regional or national command systems may also be provided. The requirements to install wide area MNS are specific to each DOD component. A general DOD requirement to install these systems on all DOD installations has not yet been established.

2-6.1.1 **Interconnection with Individual Building MNS.** The wide area MNS manufacturer shall provide a standard interface method (such as an audio line-level output and multiple relay contacts) or supply the necessary digital communication protocols to permit the DOD installation to select more than one manufacturer of individual building MNS. Depending on system architecture, the manufacturer may be required to provide a system Internet Protocol (IP) interface capable of allowing data

transfer from an outside source to internal mass notification functions via a common data communications protocol.

2-6.1.2 **Army Installations.** Wide area MNS shall be installed on Army installations in accordance with Army Chief of Staff antiterrorism guidance.

2-6.1.3 **Air Force Installations.** A wide area MNS shall be a component of and connected to the Installation Notification and Warning System (INWS) as defined by Air Force instruction (AFI) 10-2501. The INWS typically includes a “giant voice” system for outdoor notification of personnel.

2-6.1.4 **Marine Corps Installations.** Wide area MNS shall be installed on Marine Corps installations in accordance with the most current edition of Marine Corps Order (MCO) 5530.14 and MCO 3302.1.

Note: Marine Corps designs use central control stations shared by both the wide area MNS and the individual building MNS.

2-6.1.5 **Navy Installations.** Wide area MNS shall be installed on Navy installations in accordance with Chief of Naval Operations (CNO) antiterrorism guidance.

2-6.2 **Individual Building MNS.** Individual building MNS are installed to provide real-time information to all building occupants or personnel in the immediate vicinity of a building, including exterior egress and gathering areas. These systems are designed to operate from one or more locations in the building, and operate with or without connection to a wide area MNS—but must be connected to with the wide area MNS if one is provided on the DOD installation. All DOD components are required to provide individual building mass notification capability.

SE Marine Corps individual building MNS are not required to provide the capability to initiate messages from any location within the individual building.

Note: Marine Corps designs use central control stations shared by both the wide area MNS and the individual building MNS.

2-6.2.1 **DOD Requirements.** The DOD must provide mass notification for new and existing buildings when required by UFC 4-010-01. Mass notification is required in all new inhabited buildings, including new primary gathering buildings and new billeting. Mass notification is required in existing primary gathering buildings and existing billeting when implementing a project exceeding the replacement cost threshold specified in UFC 4-010-01 or when prioritized by local command personnel. Mass notification is recommended in other existing inhabited buildings when implementing a project not exceeding the replacement cost threshold. Mass notification is required for leased buildings, building additions, and expeditionary and temporary structures.

Note: UFC 4-010-01 provides specific definitions of inhabited buildings, primary gathering buildings, and billeting for application of antiterrorism requirements.

CHAPTER 3

WIDE AREA MNS

3-1 **SCOPE.** Wide area MNS are intended to provide real-time information to outdoor areas of a DOD installation. Small facilities that are exempted by UFC 4-010-01 from providing individual building MNS could be covered by a wide area MNS. These facilities could include buildings such as single-family and duplex military family housing, individual lodging buildings housing 10 occupants or less, shopettes, automobile service stations, storage buildings with very low density of occupancy, and military family campgrounds. The requirements to install wide area MNS are specific to each DOD component. A general DOD requirement to install these systems on all DOD installations has not been established.

3-2 REQUIREMENTS FOR SYSTEM DESIGNERS

3-2.1 **Designer Qualifications.** The wide area MNS shall be designed under the supervision of a registered professional engineer with a minimum of 4 years' current work experience in fire protection, electrical, and communication-electronics engineering areas specific to wide area MNS. Alternately, the wide area MNS may be designed by an engineering technologist verified by the National Institute for Certification in Engineering Technologies (NICET) as certified at Level IV in low voltage electronic-communications systems or Level IV in fire alarm systems, plus this engineering technologist shall possess a minimum of 4 years' current work experience specific to wide area MNS communications-electronics. Alternately, the wide area MNS may be designed by an engineering technologist that possesses a minimum of 10 years' documented current work experience specific to wide area MNS communications-electronics. The speaker array supporting structure shall be designed by a registered professional structural engineer to resist all environmental loads, including site-specific wind and seismic forces. The individual's name, signature, and professional engineer number or NICET certification number (when applicable) shall be included on all final design documents.

3-2.2 **System Integrators and Contractors.** Use system integrators and contractors that can demonstrate a full knowledge and understanding of systems used for mass notification, and that have factory-trained personnel to perform system design, installation, testing, training, and maintenance.

Note: The MNS designer should have demonstrated expertise in audio system design, sound pressure and intelligibility measurement and evaluation, radio communications systems, audible and visual notification appliances, and central control station designs.

3-3 **SYSTEM SIGNALS.** Wide area MNS shall include an outdoor speaker and siren system providing voice signals, music, and alarm tones.

3-3.1 **Voice Signals.** Wide area MNS shall be capable of providing intelligible live

and pre-recorded voice signals.

3-3.2 **Music.** Wide area MNS shall be capable of providing music such as the national anthem and other musical signals such as Attention to Colors, Reveille, and Taps.

3-3.3 **Tones.** Wide area MNS shall be provided with standard Federal Emergency Management Agency (FEMA) weather warning tones. Military-specific warning tones shall be provided as specified by the DOD installation, and should include tones for conventional attack warning, non-conventional attack warning, all clear, and a system test tone. Such tones should be similar to Civil Defense tones originally developed during World War II and the Cold War era.

3-4 **SUBSYSTEMS.** Wide area MNS includes several subsystems: central control stations; high power speaker arrays (HPSA); communication links; and ancillary equipment.

3-4.1 **Central Control Stations.** These stations operate and control the system.

3-4.2 **HPSA.** The speakers are used to provide the sound signals to the outdoor locations on the DOD installation.

3-4.3 **Communications Links.** Communications links are used for sending signals between the central control stations and the HPSA, and between the central control stations and regional or national command centers. A redundant (backup) means of communication shall be provided unless the primary means of communication is highly reliable, well protected, and constantly monitored by the central control station for operational status.

Note: See Appendix C for a discussion of requirements for Internet-based communication systems (under development).

3-4.4 **Ancillary Equipment.** This equipment includes items such as aircraft obstruction lights, anti-nesting spikes, and meters to meet local DOD installation requirements.

3-5 **CENTRAL CONTROL STATIONS.** The wide area MNS shall be provided with at least one primary and one redundant central control station.

3-5.1 **Locations.** The locations of the central control stations shall be coordinated with the first responders on each DOD installation. The primary central control station should be located at the installation control center (ICC), command post, emergency operations center (EOC), or similar location. The redundant central control center should be located at a physically separate location such as a security forces building, military police station, fire station, or director of emergency services office.

SE Marine Corps primary central control stations should be located at a security forces or military police dispatch center, and the redundant central control center should be located at the ICC, EOC, operations center, or similar location.

3-5.2 **On-Installation Control.** The central control stations shall control the operation of outdoor speakers on the DOD installation. Communications shall be provided between the central control stations and individual building MNS. The wide area MNS shall have the capability to communicate with other notification systems on the DOD installation such as the telephone alerting system, paging system, commander's channel on public access television stations, and highway advisory radio and sign control system (used for dynamic control of radio information and traffic signs for emergency information and traffic management).

SE Communication with other notification systems is not required for Marine Corps systems.

3-5.3 **Off-Installation Interfaces.** Communications between the central control stations and regional or national command systems shall be provided. This shall include the receipt, recording, and distributing of voice messages and alert signals received from the Commander in Chief through the national public alert and warning system.

3-5.4 **Central Control Station Requirements.** The central control unit shall consist of these components and features:

3-5.4.1 **Graphical User Interface (GUI).** This should be a computer interface with sufficient capability to operate the system with easy point and click operations.

3-5.4.2 **Backup Power.** Each central control station shall be equipped with batteries to supply power for a minimum of 4 hours of full-load operation when the central control station is provided with a permanently installed backup electrical power generator. This electrical power generator need not be dedicated solely to the central control station but may be intended to supply other important electrical loads in addition to the central control station. If not provided with a permanently installed backup electrical power generator, a portable backup electrical power generator may be used if procedures are established that ensure that the central control station is provided with electrical power within 4 hours.

3-5.4.3 **Inputs.** The central control station must provide capability for at least these features:

3-5.4.3.1 Total, zone, and single voice activations

3-5.4.3.2 Total, zone, and single tone activations

3-5.4.3.3 Total, zone, and single music activations

3-5.4.3.4 Total, zone, and single tests

3-5.4.3.5 Total, zone, and single signal cancellations

3-5.4.3.6 Automatic status reporting for each HPSA and for all activations and the status of the activations

3-5.4.3.7 Alarm summary report that provides a historical report for, at least, all changes of status, including all troubles, equipment failure, power system trouble (including normal and emergency power), unsolicited messages, tamper/supervision of the enclosure for the HPSA electronics, amplifier status, last activation and synchronization error, operator log on and log off, and configurable reports for time-based events such as “report all troubles from 1/01/04 to 6/30/04.”

3-5.4.3.8 Communications logs in tabular format

3-5.4.3.9 Screen displays of the customized DOD installation maps showing the general status of the speakers or remote equipment. This GUI shall provide for easy uploading of DOD installation-specific plan changes and for interactive operation.

Note: The DOD installation should specify the source of maps used by the GUI.

Note: Automatic recognition and display of new speakers, new remote equipment, and newly connected individual building MNS is available for some digital control systems. This feature, if provided, can significantly reduce system maintenance costs for the DOD installation.

3-5.4.3.10 Global Positioning System (GPS) coordinates of HPSA and facilities provided with an individual building MNS

3-5.4.3.11 Multiple levels of password protection, including levels for system operators, maintainers, supervisors, and military commanders, at a minimum

3-5.4.3.12 The ability to record and send digital messages to the HPSA via the primary (and redundant, if provided) communication link and to receive confirmation that the messages were received and stored at the HPSA. Alternately, the DOD installation may authorize use of fixed, pre-recorded emergency messages that are physically installed in each HPSA (typically by installing an erasable programmable read-only memory (EPROM) or flash memory device).

3-5.4.3.13 The capability to connect to and control message signs to direct vehicular traffic on roadways

 Not required for Marine Corps systems

3-5.4.3.14 The capability to deliver at least two essentially concurrent voice

messages: one for threatened areas or buildings and one for adjacent areas or buildings. This includes the capability for two pre-recorded voice messages, or one live and one pre-recorded voice message.

SE Marine Corps systems may deliver sequential voice messages (at least 2) instead of at least 2 concurrent voice messages.

3-5.4.3.15 The capability to target specific messages to any individual HPSA, zone of HPSAs, or to all areas on the DOD installation

3-5.4.3.16 Means for dynamic or “on-the-fly” configuration of zoning, with a minimum of 8 zones available

3-5.4.3.17 Secure method for easily creating or modifying recorded messages

3-5.4.3.18 The capability to store at least 60 minutes of pre-recorded messages

3-5.4.3.19 The capability to deliver text pager messages to pager stations

SE Not required for Marine Corps systems

3-5.4.3.20 The capability to deliver faxes

SE Not required for Marine Corps systems

3-5.4.3.21 The capability to connect to Reverse 911® systems and other telephone dialing/notification systems

SE Not required for Marine Corps systems

3-5.4.3.22 Microphone for live voice announcements

3-5.4.3.23 The capability to perform silent tests, including a test of the amplifiers, controllers, and sound drivers, and tests to verify that communications are operational

3-5.4.3.24 The capability to control individual speaker zones of those HPSAs designated by the DOD installation

SE Not required for Marine Corps systems

3-5.4.3.25 The capability to receive, record, and broadcast throughout the DOD installation all voice messages and alert signals received from the Commander-in-Chief through the national public alert and warning system. This will include the capability to immediately broadcast the messages and signals without a noticeable time delay, and the capability to delay the broadcast so not to interfere with operational requirements

when so authorized by the DOD installation commander.

3-6 HPSA

3-6.1 **Arrangement in Zones.** HPSAs shall be arranged into zones so that each zone can be individually controlled by the control station.

3-6.2 **Directional Characteristics.** HPSAs shall be designed with directional characteristics that will minimize the distortion of voice signals by interface from other zones, and will minimize the transmission of voice, siren, or other sound signals into environmentally sensitive areas or off the DOD installation.

Note: HPSAs with omnidirectional (i.e., approximately spherical shape) sound transmission characteristics may be considered for specific areas of the installation but should be used only for isolated areas having minimal concern for mutual interference between HPSA zones, when local operation of the HPSA is not required by the DOD installation, when Occupational Safety and Health Administration (OSHA) noise exposure levels will not be exceeded beneath the HPSA, and when omnidirectional speakers can be shown to be the most cost effective design.

 Marine Corps systems will primarily use omnidirectional, 360-degree coverage HPSAs and speaker towers to maximize the alerting coverage area; however, directional speaker towers may be used as needed to minimize off-base or host nation disturbances.

3-6.3 **Outdoor Areas.** HPSAs shall be designed to maintain the intelligibility of voice signals within the zone at a level no less than 0.7 on the Common Intelligibility Scale (CIS) or 0.5 on the Speech Transmission Index (STI) measure in outdoor areas during normal weather conditions. Intelligibility may be less than 0.7 CIS in areas of the zone if personnel can determine that a voice signal is being broadcast and they could walk less than 50 meters (m) (164 feet (ft)) to find a location in the zone with at least 0.7 CIS.

Note: Values of 0.65 through 0.74 will be rounded to 0.7.

Note: Physical limitations in outdoor sound propagation normally limit the maximum distance of personnel from the sound system speaker to the range of about 550 to 610 m (1800 to 2000 ft) for the receipt of an intelligible voice message. Increases in speaker output power may extend the sound wave propagation distance but often cause excessive distortion of the voice message and decrease intelligibility to unacceptably low levels.

Note: Commercially available test instrumentation should be used to measure intelligibility using the CIS as specified by International Electrotechnical Commission (IEC) 60849 and IEC 60268-16. Alternately, trained human speakers and listeners may be used to measure intelligibility using the STI as specified in American National

Standards Institute (ANSI) 3.2. The mean value of at least 3 readings is required to compute the intelligibility score at each test location when using the test instrumentation method.

Note: Normal weather conditions should be specified by the DOD installation as appropriate for its geographic location. Intelligibility meters with internal compensation should be used to adjust CIS measurements for other than normal weather conditions. Weather data for the DOD is maintained by the Air Force Combat Climatology Center and may be accessed for all DOD locations at <https://www2.afccc.af.mil/>. This site contains a database of engineering weather data that may be searched by installation or city name. Use of the average wind speed and direction data from the “Dry Bulb Temperature” section of the “Design Criteria Data” table is recommended.

3-6.4 Special Outdoor Areas (Army and Air Force Projects). HPSAs shall be designed to maintain the intelligibility of voice signals within the zone at a level no less than 0.8 CIS or 0.7 STI during normal weather conditions in special outdoor areas such as those with a high concentration of multi-story buildings in close proximity. Parade grounds, training fields, and similar outdoor areas should also be provided with this higher intelligibility. Many DOD installations contain one or more special outdoor areas. The boundaries of special outdoor areas shall be established by the DOD installation. Intelligibility may be less than 0.8 CIS in areas of the zone if personnel can determine that a voice signal is being broadcast and could walk less than 25 m (82 ft) to find a location in the zone with a CIS score of at least 0.8.

Note: Values of 0.75 through 0.84 will be rounded to 0.8.

Note: In special outdoor areas (such as in industrial areas with many multi-story buildings), the maximum distance of personnel from an outdoor speaker often has to be significantly reduced to retain acceptable intelligibility of the voice message. Speakers that provide directional capability should be used. These may be mounted on building exteriors if the speakers do not radiate unacceptable levels of sound into the building on which they are mounted.

Note: Physical limitations in outdoor sound propagation normally limit the maximum distance of personnel from the sound system speaker to the range of about 550 to 610 m (1800 to 2000 ft) for the receipt of an intelligible voice message. Increases in speaker output power may extend the sound wave propagation distance but often cause excessive distortion of the voice message and decrease intelligibility to unacceptably low levels.

Note: Commercially available test instrumentation should be used to measure intelligibility using the CIS as specified by IEC 60849 and IEC 60268-16. Alternately, trained human speakers and listeners may be used to measure intelligibility using the STI as specified in ANSI 3.2. The mean value of at least three readings is required to compute the intelligibility score at each test location when using the test instrumentation method.

Note: Normal weather conditions should be specified by the DOD installation as appropriate for its geographic location. Intelligibility meters with internal compensation should be used to adjust CIS measurements for other than normal weather conditions. Weather data for the DOD is maintained by the Air Force Combat Climatology Center and may be accessed for all DOD locations at <https://www2.afccc.af.mil/>. This site contains a database of engineering weather data that may be searched by installation or city name. Use of the average wind speed and direction data from the “Dry Bulb Temperature” section of the “Design Criteria Data” table is recommended.

3-6.5 **Occupational Noise Exposure.** It is necessary to control the occupational noise exposure to personnel from the HPSA to comply with Federal regulations (Title 29, Code of Federal Regulations, Parts 1910.95 and 1926.52). Sound levels at any location where personnel may be located, including directly underneath the HPSA, shall not exceed 120 decibels (adjusted) (dBA) when measured on the A-scale of a standard sound level meter at slow response. Do not exceed 85 dBA at the location of the individual HPSA equipment cabinet for those HPSAs designated by the DOD installation to be furnished with a local microphone.

Note: The 120-dBA maximum is based on the assumption that the wide area MNS will expose personnel on the ground to a sound level of 120 dBA for no more than a total of 7.5 minutes out of any 24-hour period. This noise exposure limit should accommodate most anticipated daily messages and the occasional antiterrorism exercise without exceeding OSHA limits. DOD installations that anticipate that personnel will receive a longer time of noise exposure at this sound level must establish a lower maximum value (e.g., 90 dBA will permit up to an 8-hour noise exposure, 100 dBA for 2 hours’ exposure, 110 dBA for 30 minutes’ exposure) or provide hearing protection.

3-6.6 **Noise Pollution.** At some DOD installations, it is necessary to control the amount of sound that propagates in undesirable directions, such as into civilian communities adjacent to the DOD installation boundaries or into wildlife areas with protected or endangered animal species. Additionally, in some areas it might be necessary to mount wide area MNS speakers on the side of a building while simultaneously preventing an unacceptable increase in that building’s interior noise levels.

3-6.6.1 **Design Goals.** Use speakers designed to minimize back-plane emissions for HPSA zones where the speakers will be mounted directly to an occupiable building, or where noise pollution is a concern for off-installation populated areas or sensitive wildlife areas.

3-6.6.2 **Speakers Attached to Buildings.** Speakers attached to occupiable buildings shall be capable of using phase shifting and filtering to help eliminate unwanted “spillover” emissions and back-plane noise.

3-6.6.3 **Measuring Noise in Buildings.** Back-plane noise transmitted inside of

occupiable buildings shall be no more than 15 dBA above ambient noise.

3-6.7 **HPSA inside of Buildings.** HPSA zones shall not be used to provide mass notification inside any structures when UFC 4-010-01 would require an individual building MNS if the structure were built new or renovated.

3-6.8 **HPSA Speaker Sites.** Each HPSA site for each zone shall include a field-mounted local control unit, microprocessor, amplifier, standby batteries, charger, power supply, radio, mounting brackets and loudspeaker assembly for pole or building mounting. Those HPSA sites designated by the DOD installation shall be capable of microphone input and shall be provided with a microphone designed to prevent feedback at that particular microphone location.

3-6.8.1 **Locations of Sites.** Locations of the HPSA sites shall be verified and recorded with GPS coordinates. These locations shall be established prior to the installation of speaker array supporting structures as part of a site survey conducted jointly by the installing contractor and the DOD installation.

3-6.8.2 **Equipment Cabinets.** All equipment for each HPSA speaker site shall be housed in modular, mountable cabinets suitable for the local environmental conditions, including space heaters and ventilation fans, as appropriate.

Note: Enclosures qualified to the requirements of National Electrical Manufacturers Association (NEMA) 3R (rain tight), NEMA 4 (wash-down areas), or NEMA 4X (harsh environments) should be used for all outdoor applications.

3-6.8.3 **Surge Suppression.** All external conductors (conductors passing outside of the HPSA equipment cabinet) shall be provided with surge suppression tested to Underwriters Laboratories, Inc. (UL) standards as specified by UFC 3-520-01.

3-6.9 **HPSA Performance.** The HPSA control units shall provide at least these components and features:

3-6.9.1 A digitally addressable controller

3-6.9.2 The ability to receive and store messages via the primary (and redundant, if required) communication link with a confirmation signal sent back to the primary and redundant central control stations. Alternately, the DOD installation may authorize use of fixed, pre-recorded emergency messages that are physically installed in each HPSA (typically by installing an EPROM or flash memory device).

3-6.9.3 A charger/ power supply that will accept alternating current (AC) input, backup electrical power generator input, battery input, or solar power cell input

3-6.9.4 The capability of storing at least 60 minutes of pre-recorded messages

3-6.9.5 The capability of providing a minimum of 7 standard tones. In addition, the systems shall have the capability to provide custom tones.

SE Marine Corps systems require a minimum of 6 standard tones.

3-6.9.6 The ability to accept and play an auxiliary input from a digital recording device such as a compact disk (CD) player or Moving Picture Experts Group (MPEG) Layer 3 player

3-6.9.7 An amplifier efficiency of not less than 90 percent. The amplifier shall have not more than 0.1 percent total harmonic distortion (THD). The amplifier frequency response shall be at least 200 hertz (Hz) to 10,000 Hz. There shall be no more than 2 percent THD at the speaker at 1000 Hz.

Note: Some outdoor warning systems use amplifiers that are rated for as little as 30 minutes of continuous operation. These amplifiers are often of low efficiency and may be damaged by heat buildup. Such amplifiers may be adequate for many non-emergency applications; however, higher efficiency amplifiers with improved cooling capabilities should be used to provide the capability needed for antiterrorism operations.

3-6.9.8 The capability for local control at those HPSAs designated by the DOD installation. Designated HPSAs shall be able to function independently of the central control station. Designated HPSAs shall be furnished complete with a local microphone and local controls. The local microphone shall be designed to prevent feedback at that particular microphone location.

Note: Local control capability should be designated for all HPSAs where an on-scene commander is expected to be located during emergencies. This capability should also be designated for areas used for troop formations, parade fields, parks and sports fields, areas opened to the public for air shows or fireworks displays, and any other areas where an individual HPSA could be used by the DOD installation in lieu of providing a temporary public address (PA) system.

3-6.9.9 A headphone output port to permit private listening of the system broadcast at each HPSA designated by the DOD installation for testing purposes

SE Not required for Marine Corps systems

3-6.9.10 An input port for connecting a laptop computer or digital device to make field changes. Alternately, the DOD installation may authorize use of fixed, pre-recorded emergency messages that are created elsewhere and physically installed in the HPSA (typically by installing an EPROM or flash memory device).

SE Not required for Marine Corps systems

3-6.9.11 A tamper switch that will signal the central control station that the HPSA enclosure door is open

3-6.10 **Temperature Rating.** Speakers shall be able to operate between temperatures of -40 degrees Celsius (C) (-40 degrees Fahrenheit (F)) to +60 degrees C (+140 degrees F). Enclosures shall protect the HPSA control unit from external temperatures ranging from -40 degrees C (-40 degrees F) to +60 degrees C (+140 degrees F). The DOD installation should specify an upper external temperature limit of +80 degrees C (+175 degrees F) in those geographic locations subject to extreme heat.

3-6.11 **Battery Backup Power.** Each HPSA site shall be equipped with backup batteries to supply power for a minimum of 72 hours of electrical supervision following the loss of normal charging power, followed by a total of 60 minutes of full load operation at the end of the supervisory period.

Note: The DOD installation should specify the temperature to be used to size the backup batteries for the HPSA. Weather data for the DOD is maintained by the Air Force Combat Climatology Center and may be accessed for all DOD locations at <https://www2.afccc.af.mil/>. This site contains a database of engineering weather data that may be searched by installation or city name. Use of the lowest mean minimum temperature from the “Annual Summary of Temperatures” graph is recommended. Alternately, use the minimum design temperature of the HPSA control unit enclosure if internal heating is provided within the enclosure.

3-6.12 **Connection to Portable Electrical Power Generator.** Each HPSA site so designated by the DOD installation shall be capable of direct connection to a commercially available portable electrical power generator or a military-approved mobile electrical power (MEP) generator.

3-6.13 **Elevated Supporting Structure**

3-6.13.1 **Required.** An elevated supporting structure (e.g., pole, tower) shall be provided at each HPSA site other than those attached directly to a building.

3-6.13.2 **Structural Loads, Wind and Seismic Design.** The supporting structure shall be designed for the structural loads listed in UFC 3-310-01, except that the design wind speed shall be not less than 100 miles per hour (mph) (161 kilometers per hour (km/h), 86.8 knots). The supporting structure shall be sized to accommodate the static and dynamic loads produced by the sound systems and all attachments.

3-6.13.3 **Mounting Height.** The HPSA shall be attached to the elevated supporting structure. The minimum mounting height of the speakers shall be based on the rated output of the speakers and shall prevent hearing damage to anyone directly below the speakers. Do not exceed noise exposure limits as specified in paragraph 3-6.5. The height shall not be less than 9 m (30 ft) or greater than 18 m (60 ft) above ground level.

Ensure that the location and height of HPSA supporting structures do not interfere with aircraft flight operations.

3-6.13.4 **Mounting of Cabinets.** HPSA equipment cabinets shall be mounted on the elevated supporting structure with the top of the enclosure no more than 3 m (10 ft) above ground level. The equipment cabinet and power boxes must be capable of being locked shut.

3-6.14 **HPSA attached to Buildings**

3-6.14.1 **Mounting Height.** The HPSA shall be mounted at a minimum mounting height that is based on the rated output of the HPSA and shall prevent hearing damage to anyone directly below the speakers. Do not exceed noise exposure limits as specified in paragraph 3-6.5.

3-6.14.2 **Structural Loads, Wind and Seismic Design.** The mounting of the HPSA shall be designed for the structural loads listed in UFC 3-310-01, except that the design wind speed shall be not less than 100 mph (161 km/h, 86.8 knots). The mounting shall be sized to accommodate the static and dynamic loads produced by the sound systems and all attachments.

3-6.14.3 **Sound into Building.** If attached to an occupiable building, the HPSA shall not permit unacceptable levels of sound into the building. (See paragraph 3-6.6.3.)

3-6.14.4 **Noise Exposure under HPSA.** Do not exceed the OSHA occupational noise exposure limits specified in paragraph 3-6.5.

3-7 **COMMUNICATIONS LINKS**

3-7.1 **Primary Communications Link.** Primary communications shall use radio frequency-type systems that comply with National Telecommunications and Information Administration (NTIA) requirements. The systems shall be designed to minimize the potential for interference, jamming, eavesdropping, and spoofing.

Note: See Appendix C for a discussion of requirements for Internet-based communication systems (under development).

3-7.1.1 **Licensed Radio Frequency Systems.** An approved DD Form 1494 for the system is required prior to operation. When available, use systems designed for secure digital communication standards such as the Association of Public-Safety Communications Officials (APCO) Standard 25.

Note: APCO 25 is an industry-wide effort to set the recommended voluntary standards of uniform digital two-way radio technology for public safety organizations.

Note: Receiving a new radio frequency assignment often takes a relatively long time. Be sure to request the frequency assignment early in the design process.

3-7.1.2 Non-licensed Radio Frequency Systems. When authorized by the DOD installation commander, the NTIA permits the use in the continental United States (CONUS) of non-licensed radio frequency-type devices that conform to Federal Communications Commission (FCC) rules and regulations (47 CFR 15); however, all transmitting devices on a military installation require an approved DD Form 1494 prior to installation. In locations outside of the continental United States (OCONUS), confirm that the devices conform to host-country regulations and obtain the approval from the DOD installation commander prior to using non-licensed radio frequency-type devices. In all cases, request permission from the spectrum manager for the local area. Provide GPS coordinates of installed transmitters when required by the spectrum manager.

Note: Non-licensed devices operate at very low power levels, have no vested or recognized right to any part of the radio frequency spectrum, and are not required to provide any immunity to interference. If a non-licensed system is selected, be sure the system compensates for these limitations by providing suitable radio signal modulation features (e.g., spread spectrum and frequency hopping) and that propagation distance parameters for the radio signals are not exceeded.

3-7.2 Redundant Communications Link. Redundant communication means (when required) should be established using several alternate wireless radio frequency paths to the radios. In some cases, the redundant communication means might be accomplished by using the DOD installation's communications backbone network (e.g., optical fiber cable). In this case, the central control units should accomplish this by being directly connected to the backbone network.

Note: All software and hardware to be installed on DOD Ethernet or Internet systems must first successfully complete an accreditation process. Accreditation often takes a relatively long time.

Note: See Appendix C for a discussion of requirements for Internet-based communication systems (under development).

3-7.3 Off-the-Shelf Equipment. Communications equipment furnished as part of the wide area MNS shall be commercial off-the-shelf (COTS). All programming codes or passwords required to access, update, modify, and maintain the communications equipment shall be provided to the DOD installation no later than the date of final system acceptance.

Note: Receiving authorization to operate any communications equipment often takes a relatively long time. Be sure to request approval early in the design process. At some DOD installations, a Certificate to Operate (CTO) or Certificate of Networthiness (CON) is required.

3-7.4 **Supervision.** Full system supervision shall be provided. Notification of system alarm, supervisory, and trouble signals shall be provided to the central control stations within a time period not to exceed 200 seconds.

3-7.5 **Diagnostics.** The communications systems shall provide self-test and diagnostics capabilities. Local diagnostics information shall be transmitted to the central control stations.

3-7.6 **Interfaces with Other Systems.** The communications systems shall be capable of interfacing with existing fire alarm systems, existing PA systems, and existing telephone dialing systems on the DOD installation. The communications systems shall be designed with an established protocol that is provided to the DOD installation to allow existing and future individual building MNS from other manufacturers to interface with the wide area MNS. The wide area MNS manufacturer shall provide a standard interface method (such as an audio line-level output and multiple relay contacts) or supply the necessary digital communication protocols to permit the DOD installation to select more than one manufacturer of individual building MNS.

 Marine Corps systems will interface with the telephone dialer system that has been approved by the AHJ. (See paragraph 1-3.4 for more information on the AHJ).

CHAPTER 4

INDIVIDUAL BUILDING MNS FOR NEW CONSTRUCTION PROJECTS

4-1 **SCOPE.** Individual building MNS are intended to provide real-time information to personnel within and in the immediate vicinity of buildings on a DOD installation. These systems are required by UFC 4-010-01 for new construction and renovation of existing buildings. This chapter provides the design criteria for new construction projects. It discusses the requirements of the individual building MNS that is installed in new construction as part of a combined MNS/fire alarm system.

Note: In most cases, the simplest and most economical approach for new construction will be to install a combined system that performs both as an individual building MNS and as the building fire alarm/voice evacuation system.

4-2 **REQUIREMENTS FOR SYSTEM DESIGNERS.** The individual building MNS shall be designed under the supervision of a registered fire protection engineer, by a registered professional engineer having at least four years of current experience in the design of fire protection and detection systems, or by an engineering technologist qualified at NICET Level IV in fire alarm systems. The individual's name, signature, and professional engineer number or NICET certification number shall be included on all final design documents.

SE Navy systems shall be designed only by a registered fire protection engineer who has passed the fire protection engineering written examination administered by the National Council of Examiners for Engineering and Surveys (NCEES).

4-3 **SYSTEM OVERVIEW.** A combined system is required by the Navy and is highly recommended by the Army and Air Force. The combined system design may be used by the Marine Corps when specifically approved by the AHJ based on the class and size of the building requiring the MNS. Otherwise, Marine Corps projects will use the technical criteria of Chapter 5. If an Army or Air Force installation approves use of a separate MNS and separate building fire alarm system in a new construction project, use the technical criteria of Chapter 5.

SE A separate MNS may be installed in Navy projects for a building not provided with a fire alarm system. See Chapter 5.

Note: See paragraph 6-5 for MNS requirements for special occupancies such as medical facilities and facilities intended for occupancy by persons not capable of self-preservation.

4-3.1 **Subsystems.** An individual building MNS for new construction projects includes several subsystems: autonomous control unit (ACU); local operating consoles (LOC); notification appliance network; and interface with the wide area MNS on the DOD installation. System design and wiring is designed to meet NFPA 72 requirements for MNS and fire alarm systems.

4-3.2 ACU

4-3.2.1 **Functions.** The ACU is used to monitor and control the notification appliance network. At the ACU, personnel in the building can initiate delivery of pre-recorded voice messages, provide live voice messages and instructions, and initiate visual strobe and alphanumeric message notification appliances. Actions taken at the ACU take precedence over actions taken at any other location, including the LOC, or inputs from the wide area MNS on the DOD installation.

4-3.2.2 **Combined System.** For new construction, the ACU shall be integrated with the building fire alarm control panel (FACP) to form one combined system that performs both functions. The building PA system for smaller buildings may be integrated with the combined system so that all three functions—mass notification, fire alarm, and PA—are provided by one building system. In large buildings, however, combining the PA system will typically require the design of very complex speaker switching matrices and is not recommended. Combined systems shall meet the requirements of NFPA 72.

Note: A combined system may include an ACU and FACP supplied from different manufacturers or placed in separate equipment enclosures; however, the ACU and FACP must be integrated in their controls and performance to meet the requirements of NFPA 72 and this UFC.

Note: The Army and Air Force permit the MNS and fire alarm system to be installed as separate systems if mandated by the DOD installation. The Marine Corps normally requires the MNS and fire alarm system to be installed as separate systems unless specifically permitted by the AHJ. See Chapter 5 for technical criteria for this design approach.

4-3.3 **LOC.** A LOC is a unit designed to allow emergency response forces and building occupants to operate the individual building MNS, including initiating delivery of pre-recorded voice messages, providing live voice messages and instructions, initiating visual strobe and alphanumeric message notification appliances, overriding external voice announcements, and terminating mass notification functions. A LOC is usually contained in a small, wall-mounted enclosure. Not all functions that could be performed at the ACU are necessarily available at a LOC.

4-3.4 **Notification Appliance Network.** A notification appliance network consists of a set of audio speakers, strobes, and text signs (when required) that are located to alert occupants and provide intelligible voice and visual instructions.

4-3.4.1 **Audio Appliance Network.** Speakers are provided at all locations in the building and also around the building at entrances/exits and other outdoor areas (such as courtyards) commonly used by the building occupants. Important design considerations for the audio speakers include intelligibility and audio intensity.

Note: Outside notification more than 5 m (16 ft) from the building should be provided by the wide area MNS.

4-3.4.1.1 Intelligibility is defined in NFPA 72. Commercially available test instrumentation shall be used to verify intelligibility.

4-3.4.1.2 Effective voice communication within buildings occurs by using a system design of many speakers, each with low audio intensity.

4-3.4.2 **Visual Appliance Network.** Strobes are provided at all locations inside the building to meet the accessibility requirements of \1\ ABAAG /1/ for persons with hearing disabilities. Strobes are provided at the same locations in a building that would be required for a fire alarm system notification appliance. Combined MNS/FACP systems may use either one strobe (clear) or two strobes (clear for fire and amber for MNS) as specified by the AHJ.

4-3.4.2.1 Navy installations shall use one clear strobe and also shall provide text signs. Text signs are required over the door to each egress stairwell and over (or adjacent to) the substantial means of egress from the level of discharge. Exterior exit doors from a single room (e.g., mechanical or electrical rooms) do not require a text sign.

4-3.4.2.2 Army and Air Force installations shall use a clear strobe for fire and an amber strobe for MNS. Use of text signs is optional and at the discretion of the DOD installation. If provided, text signs shall be located over the door to each egress stairwell and over (or adjacent to) the substantial means of egress from the level of discharge. Exterior exit doors from a single room (e.g., mechanical or electrical rooms) do not require a text sign.

4-3.4.2.3 Marine Corps installations shall contact the AHJ for guidance on visual notification appliances.

4-3.5 **Interfaces with the Wide Area MNS.** If a wide area MNS is provided on the DOD installation, the individual building MNS communicates with the central control units of the wide area MNS to provide status information, receive commands, activate pre-recorded messages, and originate live voice messages. If no wide area MNS is provided on the DOD installation, at a minimum, the individual building MNS shall be able to receive an audio line-level input.

4-3.6 **Logical Block Diagrams.** Figures 4-1 and 4-2 show the logical block diagrams for acceptable configurations of the individual building MNS for new construction.

Note: These diagrams are intended to show only the functional relationships of the major components. They are not intended to serve as wiring diagrams. Many essential design features for an operational system, such as end-of-line resistors, are not shown.

Figure 4-1. Individual Building Mass Notification System:
Combination Fire Alarm System and MNS (Navy)

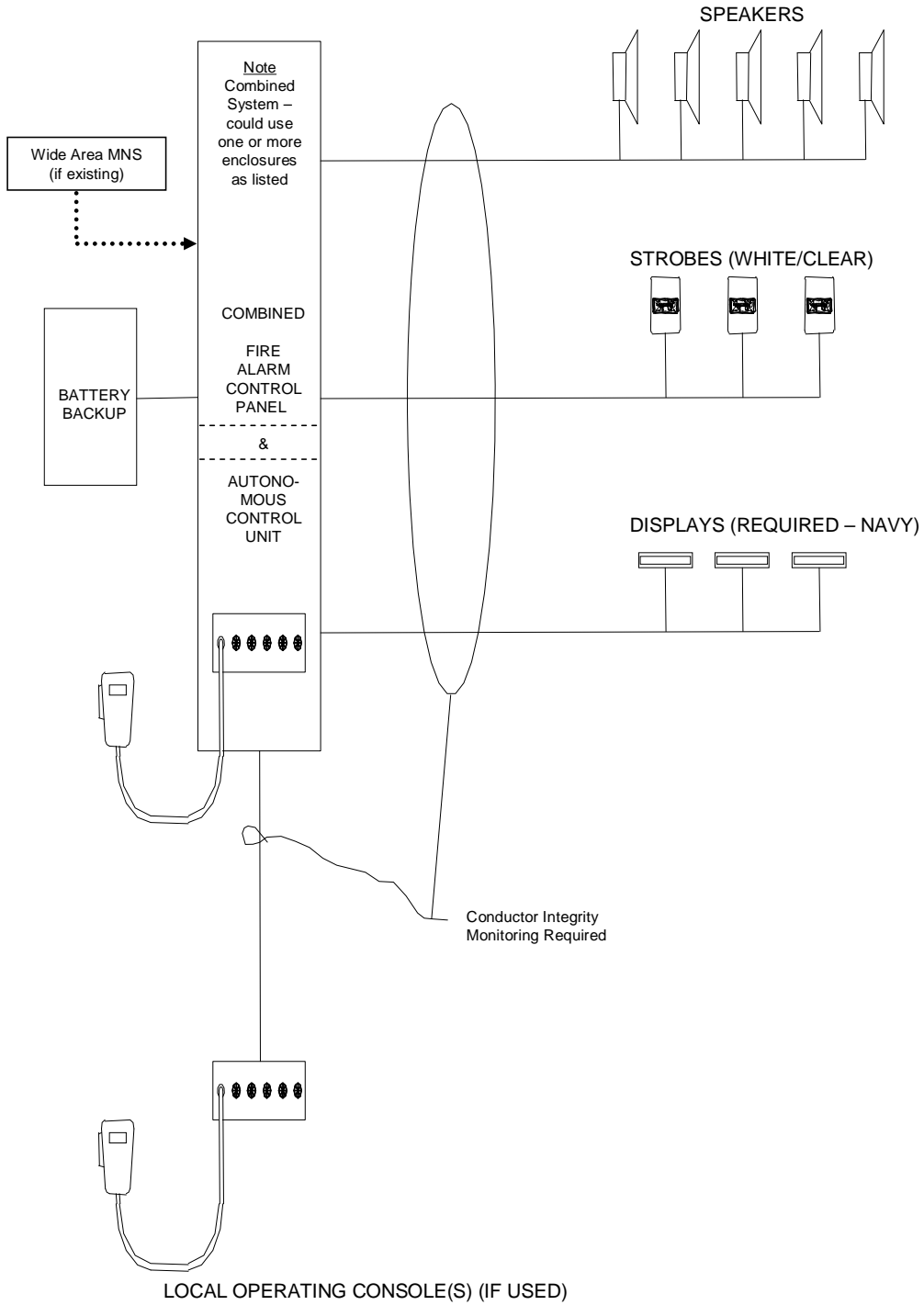

**Figure 4-2. Individual Building Mass Notification System:
Combination Fire Alarm System and MNS (Army and Air Force)**

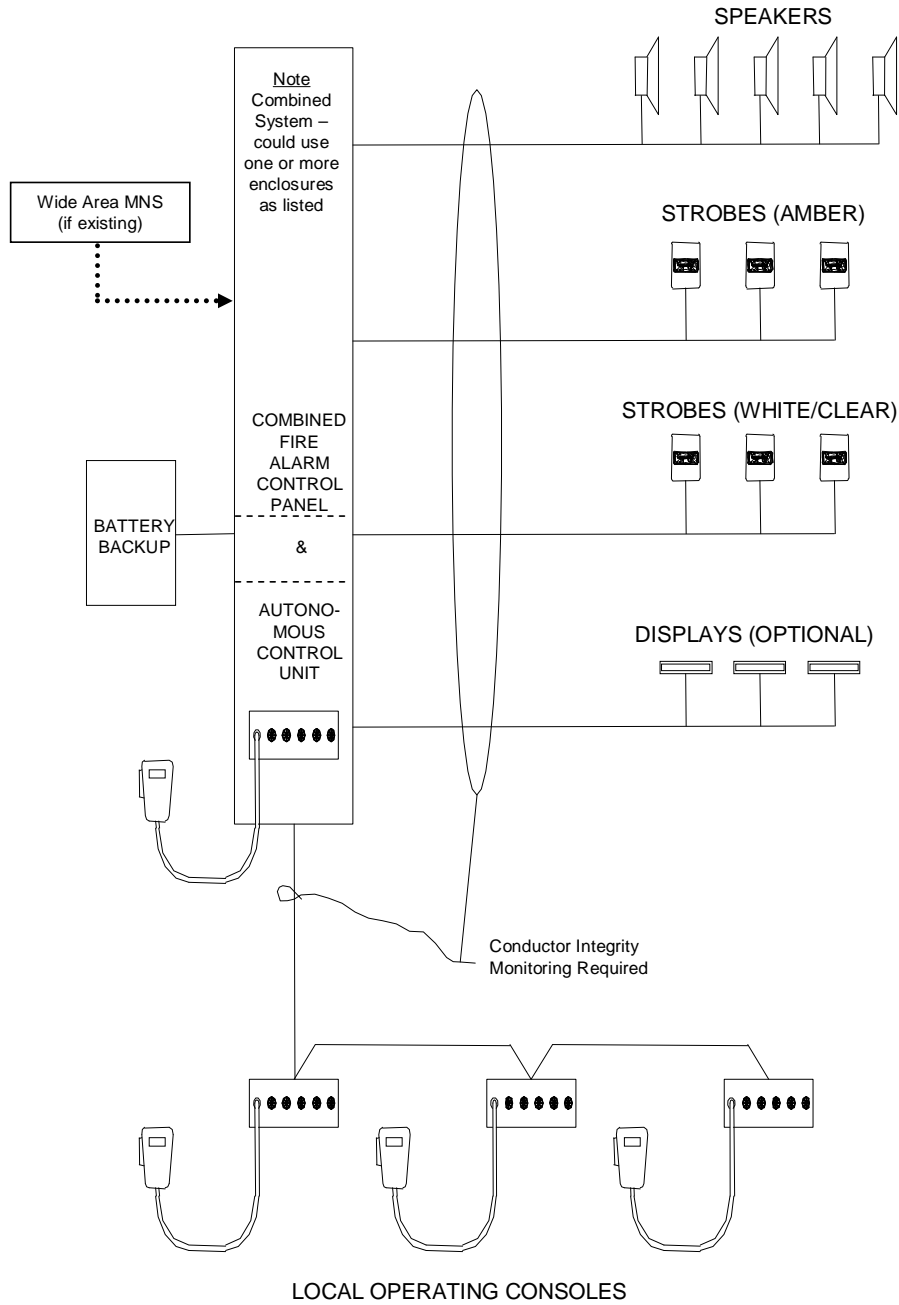

4-4 ACU

4-4.1 **Locations.** The ACU shall form a combined system with the FACP. These control panels may be co-located in the same enclosure or may be physically separated. If they are located in the same enclosure, install the enclosure at the location normally specified by the DOD component AHJ for a stand-alone FACP.

4-4.2 **Design Features.** The ACU shall:

- Be able to function independently upon failure of the wide area MNS (if provided on the DOD installation).
- Be a listed combination system with the fire alarm system as described in NFPA 72 and meeting UL Standard 864 and the specific requirements of this UFC. The listing evaluation shall be accomplished by UL, Factory Mutual Research Corporation (FM), or another nationally recognized testing laboratory (NRTL).

Note: Systems designed to UL 2017 instead of UL 864 may not be used for a combination system. Systems designed to UL 2017 are permitted for a MNS separate from the fire alarm system (see Chapter 5).

- Be able to activate strobes and text signs:
 - Navy: Energize clear strobe lights marked “ALERT” along with light-emitting diode (LED)-type text signs. Text signs are required over the door to each egress stairwell and over (or adjacent to) the substantial means of egress from the level of discharge. Exterior exit doors from a single room (e.g., mechanical or electrical rooms) do not require a text sign. Strobes shall meet all UL listing requirements for fire alarm system strobes except for the marking “ALERT.”
 - Marine Corps: Contact the AHJ for guidance on visual notification appliances.
 - Army and Air Force: Energize either one set of clear strobe lights marked “FIRE” for the fire alarm system or a separate set of amber strobe lights marked “ALERT” for the MNS as appropriate for the emergency. Energize LED-type text signs if required by the DOD installation.
- Make general paging or other non-emergency messages available without the activation of strobes. A separate microphone must be provided for this purpose.
- Have the ability to interrupt PA system announcements and to silence building background music while delivering voice messages.

- Be able to accept voice messages from the DOD installation telephone system
- Have conductor connections that comply with NFPA 72.

Note: Ethernet or IP connections for initiating and indicating circuits are not currently available that will meet NFPA 72 requirements and, therefore, may not be used. Additionally, all software and hardware to be installed on DOD Ethernet or Internet systems must first successfully complete an accreditation process. Accreditation often takes a relatively long time.

- Have conductor integrity monitoring for strobes, speaker wiring, power supplies, and connections to the LOC.
- Be able to switch between MNS and fire alarm notification functions without generating trouble alarms in either system.
- Have the capacity for multiple pre-recorded messages (at least eight, but more if required by the DOD installation). Pre-recorded messages shall be passed in the English language and, for OCONUS locations, also in the predominant language(s) used by the host nation. Pre-recorded messages, if used, should address at least these subjects:
 - Bomb threat or actual bomb within/around the building
 - Intruder/hostile person sighted within/around the building
 - Directions to occupants to take cover within the building
 - Evacuation of the building using exits other than the normal main entrance/exit (since the front entrance/exit is often a location targeted by terrorists)
 - Emergency weather conditions appropriate for the local area
 - “All Clear” message
 - A test message intended for verifying functionality of the system.

 The Marine Corps AHJ will determine the number and content of pre-recorded messages.

- \1\ Provide an alerting sound prior to playing pre-recorded messages. The alerting sound for fire alarm messages shall be different than that used for other pre-recorded messages. The fire alarm alerting sound for buildings other than child development centers shall be either the temporal three-tone or the slow whoop for fire alarm messages, unless otherwise approved by the

approving authority (i.e., the AHJ for the Navy and Marine Corps; the DOD installation in conjunction with the contracting officer for the Army and Air Force). The fire alarm alerting sound for child development centers shall be a chime sound. /1/

- Be able to deliver messages quickly.
- Be able to automatically repeat pre-recorded messages until they are terminated.
- Have a microphone for delivering live voice messages.
- Have adequate discrete outputs to initiate text signs and initiate strobes.
- Interface to the LOC for initiating recorded messages and delivering live voice messages from locations in the building other than at the ACU.
- Establish priority for passing messages to prevent interference between the ACU, LOC, and the wide area MNS on the DOD installation.
- Allow the MNS to temporarily override fire alarm audible messages and visual signals, and to provide intelligible voice commands during simultaneous fire and terrorist events. All other features of the fire alarm system, including the transmission of signals to the fire department, shall function properly. MNS messages shall take priority and continue to override fire alarm audible messages until the MNS message is either manually or automatically ended. If not manually ended, the MNS message will automatically end after 10 minutes.
- Provide a supervisory signal if the MNS is used to override fire alarm audible messages and visible signals during simultaneous fire and terrorist events. The supervisory signal shall be annunciated at the FACP and any remote fire alarm annunciators and be transmitted to the fire department. The visual annunciation of the separate supervisory signal shall be distinctly labeled or otherwise clearly identified.

SE The Army requires that this supervisory signal be separate from other fire alarm system supervisory signals.

- Remote monitoring of trouble, supervisory, and alarm functions to a constantly occupied location meeting the requirements of NFPA 72
- Have a single switch or operating mechanism capable of shutting down all heating, ventilating, and air conditioning (HVAC) equipment in the facility in accordance with the requirements of UFC 4-010-01. If permitted by the DOD installation, this shutdown capability may be provided at a LOC or be deleted entirely if the capability is otherwise provided at a location readily accessible

to building occupants.

- Provide a complete set of self-diagnostics for the controller and appliance network.
- Have a local diagnostic information display.
- Provide a local system event log file.

4-4.3 **Off-the-Shelf Equipment.** ACU equipment furnished as part of the individual building MNS shall be COTS and shall be tested to the standards of UL or FM by a NRTL.

4-4.4 **Programming Codes.** All programming codes or passwords required to access, update, modify, and maintain the ACU shall be provided to the DOD installation no later than the date of final system acceptance.

4-4.5 **Power Supply Features.** The power supply shall:

- Be capable of accepting 120/240 VAC, 50/60 Hz.
- Be appropriate for a MNS/FACP system that meets at least the minimum NFPA 72 requirements for standby power capacity. In addition, secondary (standby) power should be provided as follows: immediately upon loss of normal AC power, the standby source of power shall provide a minimum of 60 minutes of mass notification at the maximum connected load.
- Disable use of any microphones intended solely for general paging or other non-emergency messages upon loss of normal AC power.
- Conform to applicable sections of NFPA 72.
- Use only COTS components.
- Provide surge protection in accordance with UFC 3-520-01.

4-5 **LOC**

4-5.1 **Locations.** Provide a LOC to allow emergency response forces and building occupants to access the MNS and originate messages in emergency situations from locations in the building other than from the ACU. Follow these requirements:

- Provide a separate LOC for use by the fire department near the building FACP (or fire command center) unless this is also the location of the ACU.
- Do not place a LOC inside a locked room or closet (with the possible exception of the LOC intended for use by the fire department near the FACP).

- Install a LOC at those facility entrances/exits that will be used when building access is limited because of elevated terrorism threat levels.

Note: This LOC is intended to enable immediate notification of building occupants when unauthorized building access is threatened or has occurred at this location.

- Army and Air Force: Provide a LOC so that occupants do not need to travel more than 61 m (200 ft) horizontally or to travel to other floors to access a LOC.
- Army and Air Force: Make a LOC available for use by visitors in those facilities open to unescorted visitors or to the public.
- Navy: Provide no more than one LOC (if necessary) in addition to the ACU. Locate the LOC as directed by the responsible fire protection engineer.
- Marine Corps: Provide no more than one LOC (if necessary) in addition to the ACU. Locate the LOC as directed by the AHJ.

4-5.2 **Design Features.** The LOC shall:

- Have a remote microphone station that emulates operation of the MNS from the ACU.
- Have an easy method (such as individual manual activation push buttons) of activating the MNS pre-recorded messages. Signage shall be provided to allow rapid recognition of the means of initiating the pre-recorded messages.

 Activation of MNS pre-recorded messages is not required for Marine Corps LOC.

- Provide a single switch or operating mechanism capable of shutting down all HVAC equipment in the facility in accordance with the requirements of UFC 4-010-01. If permitted by the DOD installation, this shutdown capability may be provided at only one LOC when multiple LOCs are installed, or be deleted from all LOCs if the capability is otherwise provided at a location readily accessible to building occupants.
- Be protected in a small, wall-mounted enclosure.
- Have supplemental heating and ventilation for those enclosures located outdoors or in areas where the LOC will be exposed to temperatures or humidity outside of the manufacturer's design limits.
- Be protected from tampering by use of a break-glass, thumb-lock, tamper wire, tamper alarm, or equivalent protection. This is not required in those

facilities with limited access so that unauthorized use would not reasonably be expected to occur. Enclosures that can be opened only by a key shall not be used.

SE Marine Corps LOC may use key-operated locks when emergency response forces are provided with immediate access (e.g., master key, Knox-box®)

- Have signage on the outside of the enclosure similar to “Mass Notification” and “HVAC Emergency Shutdown” (if applicable).

4-6 NOTIFICATION APPLIANCE NETWORK

Note: Also see paragraph 6-5 for notification appliance requirements in special occupancies.

4-6.1 **Audible Appliance Network.** These are the requirements of the audible appliance network:

- Provide appliances capable of satisfying \1\ ABAAG. /1/
- Use speakers suitable for the intended climatic and environmental conditions.
- Use speakers suitable for installation in commercial/industrial applications with consideration of electrically hazardous (classified) locations.
- Provide speakers and installation methods compliant with Director of Central Intelligence Directive (DCID) 6/9 for areas classified as sensitive, compartmented information facilities (SCIF).
- Speakers shall meet the listing requirements of UL Standard 1480.
- System design shall comply with NFPA 72.
- Provide speakers at all locations inside a building where the building fire alarm must be audible.
- \1\Ensure speakers in the vicinity of the ACU and LOC will not create acoustical feedback or otherwise interfere with the ability to deliver live voice messages./1/
- Provide speakers mounted on the exterior of the building to provide notification of any areas commonly used by building occupants. These include courtyards, covered break areas, designated smoking areas, and sidewalks leading from the building’s exit doors to a public street or from parking areas for a distance up to 5 m (16 ft) from the building. Use speakers with directional characteristics that transmit minimal backplane noise when mounted on the sides of the building. Generally, the speakers should be

located near entrance/exit doors.

- Provide an effective voice communication within buildings using a design including many speakers, each with low audio intensity.
- Install speakers with field-adjustable tap settings to allow adjustment after installation to meet audibility and intelligibility requirements.
- Do not use speakers exceeding 15 watts (W) for indoor applications without prior approval of the AHJ.
- Wiring methods shall comply with NFPA 72. Class B wiring is permitted unless Class A wiring is required for fire alarms systems on the DOD installation.

4-6.1.1 **Speaker Design Recommendations**

- Speakers rated at 2 W or less and with multiple tap settings to adjust the output power can often provide acceptable sound quality in most occupied areas.
- Speakers rated at 8 W or less and with multiple tap settings can often provide acceptable sound quality for most large or very noisy areas.
- Speakers rated at 8 to 10 W for interior distribution should be used when the speakers are also intended to meet the better sound quality normally expected from PA systems. These speakers should be capable of a frequency response over the range at least 200 Hz to 10,000 Hz.

Note: Such speakers are often adjusted to operate at a tap setting of 2 W or less, but are used because their sound quality is greatly superior to the small speakers typically used in fire alarm systems.

4-6.1.2 **\1\ Intelligibility /1/ Requirements**

- Verify intelligibility by measurement after installation.
- \1\ Ensure that a CIS value greater than the required minimum value is provided in each area where building occupants typically could be found. The minimum required value for Navy and Marine Corps is 0.7 CIS. The minimum required value for Army and Air Force is 0.8 CIS, although rounding is permitted such that a value of 0.75 may be rounded to 0.8. /1/
- Areas of the building provided with hard wall and ceiling surfaces (such as metal or concrete) that are found to cause excessive sound reflections may be permitted to have a CIS score less than \1\ the minimum required value /1/ if approved by the DOD installation, and if building occupants in these areas

can determine that a voice signal is being broadcast and they must walk no more than 10 m (33 ft) to find a location with at least \1\ the minimum required CIS value within the same area. /1/

- Areas of the building where occupants are not expected to be normally present are permitted to have a CIS score less than \1\ the minimum required value /1/ if personnel can determine that a voice signal is being broadcast and they must walk no more than 15 m (50 ft) to a location with at least \1\ the minimum required CIS value within the same area. /1/
- Measurements should be taken near the head level applicable for most personnel in the space under normal conditions (e.g., standing, sitting, sleeping, as appropriate).
- \1\ The distance the occupant must walk to the location meeting the minimum required CIS value shall be measured on the floor or other walking surface as follows:
 - Along the centerline of the natural path of travel, starting from any point subject to occupancy with less than the minimum required CIS value.
 - Curving around any corners or obstructions, with a 300-mm (12 in.) clearance therefrom.
 - Terminating directly below the location where the minimum required CIS value has been obtained. /1/
- Commercially available test instrumentation shall be used to measure intelligibility as specified by IEC 60849 and IEC 60268-16. The mean value of at least three readings shall be used to compute the intelligibility score at each test location.
- \1\ Occasionally, large DOD buildings are designed to provide cavernous-type open areas to meet unique operational requirements. Such areas are typically designed with hard wall and ceiling surfaces (such as metal or concrete) without acoustical treatments, and this has been found to cause excessive sound reflections that prevent obtaining the normal, minimum required CIS value. In such facilities, the cavernous-type open area is permitted to have locations with a CIS value lower than the normal, minimum required CIS value when the following conditions are met:
 - The requirement for a deviation from the normal, minimum CIS criteria is identified in the design phase.
 - Justification for the deviation from the normal, minimum CIS criteria is provided to the approving authority (i.e., the AHJ for the Navy and Marine Corps; the DOD installation in conjunction with the contracting officer for

the Army and Air Force). The justification shall address all factors relevant to the request for deviation from normal, minimum CIS criteria, including, but not limited to: the operational requirements that restrict the installation of acoustical wall and ceiling treatments; the potential use of special speaker technologies such as directional speakers or stacked speaker systems; and, the availability of physically larger or higher-fidelity speakers even though such speakers might not be listed for fire alarm use.

Note: Deviation from normal, minimum CIS criteria should not be requested for the design of normal, large, open areas that are typically found in permanent DOD buildings, such as dining halls, theaters, and gymnasiums. The potential for deviation from normal criteria is intended to address the rare exception to normal criteria that is sometimes needed for DOD buildings with unique operational requirements.

- Building occupants located in the large, cavernous area can adequately understand the message content in the voice signal being broadcast. Whether the voice message is adequately understood shall be determined by the approving authority (i.e., the AHJ for the Navy and Marine Corps; the DOD installation in conjunction with the contracting officer for the Army and Air Force).
- The CIS value is not less than 0.6 at any location within the large, cavernous area.
- The building occupants in the large, cavernous area must walk no more than 30 m (98 ft) to find another location within the large, cavernous area having at least the normal, minimum required CIS value. /1/

Note: An STI score of 0.5 is considered equivalent to a CIS score of 0.7. \1\ An STI value of 0.7 is considered equivalent to a CIS value of 0.8. /1/

4-6.1.3 \1\ DELETED /1/

4-6.2 **Visual Appliance Network.** These are the requirements for the visual appliance network:

- Provide visual appliances capable of satisfying \1\ ABAAG. /1/
- Use visual appliances suitable for the intended climatic and environmental conditions.
- Use visual appliances suitable for installation in commercial/industrial applications with consideration of electrically hazardous (classified) locations.
- Strobes shall meet the listing requirements of UL Standards 1638 and 1971.

Text signs shall comply with UL Standard 48.

- Strobes are not required outside the building.
- Where more than two visible notification appliances are in any field of view, they shall flash in synchronization.
- Wiring methods shall comply with NFPA 72. Class B wiring is permitted unless required otherwise by the local AHJ.

4-6.2.1 **Navy-Specific Requirements**

- Provide clear strobes marked with the word “ALERT” for shared use by the building’s combination MNS/FACP.
- Provide LED text signs. Text signs are required over the door to each egress stairwell and over (or adjacent to) the substantial means of egress from the level of discharge. Exterior exit doors from a single room (e.g., mechanical or electrical rooms) do not require a text sign. (See Chapter 7 for operational requirements and information on message content.)

4-6.2.2 **Marine Corps-Specific Requirements**

- Contact the AHJ for guidance on visual notification appliances.

4-6.2.3 **Army- and Air Force-Specific Requirements**

- Provide amber-colored strobes marked with the word “ALERT” to alert the hearing impaired. Provide these strobes in addition to existing clear strobes provided for the building fire alarm system.
- Amber strobes activated in conjunction with the delivery of a pre-recorded voice message shall operate continuously until message termination. Amber strobes activated in conjunction with the delivery of a live voice message shall operate during the message and for not less than 15 seconds after the message ends.
- Clear/white strobes activated by the fire alarm system shall not operate during those periods when the amber strobes are in operation, but otherwise shall operate continuously until the fire alarm system is reset.

4-7 **INTERFACES WITH WIDE AREA MNS.** The individual building MNS shall be capable of being interoperable with an existing wide area MNS. If a wide area MNS is not presently provided on the DOD installation, the individual building MNS shall be designed to allow future interface with a wide area MNS procured from another manufacturer. The electrical requirements, computer codes, or other protocols that are needed to interface the systems shall be provided to the DOD installation.

Note: When a wide area MNS is provided on the DOD installation, the system manufacturer should provide a standard method (such as an audio line-level output and multiple relay contacts) or supply the necessary digital communication protocols to permit the DOD installation to select more than one manufacturer of individual building MNS. Depending on system architecture, the manufacturer may be required to provide a system IP interface capable of allowing data transfer from an outside source to internal mass notification functions via a common data communications protocol.

CHAPTER 5

INDIVIDUAL BUILDING MNS FOR RENOVATION PROJECTS

5-1 **SCOPE.** Individual building MNS are intended to provide real-time information to personnel within and in the immediate vicinity of buildings on a DOD installation. These systems are required by UFC 4-010-01 for new construction and renovation of existing building. This chapter provides the design criteria for renovation projects, including the installation of MNS in existing buildings. This chapter should be used for new Marine Corps projects unless combination systems (see Chapter 4) are specifically approved by the AHJ. This chapter should also be used when an Army or Air Force installation approves the use of a separate MNS and separate building fire alarm system in a new construction project.

Note: See paragraph 6-5 for MNS requirements for special occupancies such as medical facilities and facilities intended for occupancy by persons not capable of self-preservation.

5-2 **REQUIREMENTS FOR SYSTEM DESIGNERS.** The individual building MNS shall be designed under the supervision of a registered professional engineer with a minimum of 4 years of current work experience in fire protection, electrical, and communication-electronics engineering areas specific to individual building MNS. Alternately, the individual building MNS may be designed by an engineering technologist verified by NICET as certified at Level IV in low voltage electronic-communications systems or at Level IV in fire alarm systems, plus this engineering technologist shall possess a minimum of 4 years current work experience specific to individual building MNS communications-electronics. Alternately, the individual building MNS may be designed by an engineering technologist that possesses a minimum of 10 years of documented current work experience specific to individual building MNS communications-electronics. The individual's name, signature, and professional engineer number or NICET certification number (when applicable) shall be included on all final design documents.

5-3 USE OF NEW CONSTRUCTION CRITERIA

5-3.1 **FACP Replacement: No Existing MNS in Building.** When replacing a FACP in a building without an existing MNS, provide a combination mass notification and fire alarm system meeting the requirements for new construction projects (see Chapter 4).

5-3.2 FACP Replacement: Existing MNS in Building

5-3.2.1 When replacing a FACP in a building with an existing separate MNS, removal of both systems and installation of a combination system meeting new construction criteria is recommended but not required. Consider the age and condition of the MNS and the life-cycle costs of keeping the existing MNS when determining whether to install a new combined system or remain with separate systems.

5-3.3 MNS Installation Projects

5-3.3.1 When installing a MNS in a building with an existing separate FACP, removal of both systems and installation of a combination system meeting new construction criteria is recommended but not required. Consider the age and condition of the FACP and the life-cycle costs of keeping the existing FACP when determining whether to install a new combined system or remain with separate systems.

SE Separate systems are required for Marine Corps projects unless a combination system is specifically permitted by the AHJ.

5-4 SYSTEM OVERVIEW

5-4.1 **Subsystems.** An individual building MNS for renovation projects includes several subsystems: ACU; LOC; notification appliance network; interface with facility FACP; interface with facility PA system; and interface with the wide area MNS on the DOD installation. System design and wiring must meet NFPA 72 requirements for MNS and fire alarm systems.

SE Individual building MNS for Marine Corps projects shall serve as a subsystem of the wide area MNS.

5-4.2 **ACU.** The ACU is used to monitor and control the notification appliance network. At the ACU, personnel in the building can initiate delivery of pre-recorded voice messages, provide live voice messages and instructions, initiate visual strobe and alphanumeric message notification appliances, and temporarily silence fire alarm system visual and audible notification appliances.

SE Marine Corps MNS designs are not required to use an ACU.

5-4.3 **LOC.** A LOC is a unit designed to allow emergency response forces and building occupants to operate the individual building MNS, including initiating delivery of pre-recorded voice messages, providing live voice messages and instructions, initiating visual strobe and alphanumeric message notification appliances, temporarily silencing fire alarm system visual and audible notification appliances, overriding external voice announcements, and terminating mass notification functions. A LOC is usually contained in a small, wall-mounted enclosure. Not all functions that could be performed at the ACU are necessarily available at a LOC.

SE Marine Corps MNS designs are not required to use a LOC.

5-4.4 **Notification Appliance Network.** A notification appliance network consists of a set of audio speakers, strobes, and text signs (when required by the AHJ) located to alert occupants and provide intelligible voice and written instructions. When required, text signs are installed over the door to each egress stairwell and over (or adjacent to)

the substantial means of egress from the level of discharge. Exterior exit doors from a single room (e.g., mechanical or electrical rooms) do not require a text sign.

 Text signs are not authorized in Marine Corps MNS designs unless specifically permitted by the AHJ.

5-4.4.1 Audio Appliance Network. Speakers are provided at all locations in the building and are provided around the building at entrances/exits and other outdoor areas (such as courtyards) commonly used by the building occupants. Important design considerations for the audio speakers include intelligibility and audio intensity.

Note: Outside notification more than 5 m (16 ft) from the building should be provided by the wide area MNS.

5-4.4.1.1 Intelligibility is defined in NFPA 72. Commercially available test instrumentation shall be used to verify intelligibility.

5-4.4.1.2 Effective voice communication within buildings occurs by using a system design of many speakers, each with low audio intensity.

5-4.4.2 Visual Appliance Network. Strobes are provided at all locations inside the building to meet \1\ ABAAG /1/ for persons with hearing disabilities. Strobes are provided at the same locations in a building that would be required for a fire alarm \1\ visual /1/ notification appliance. Separate MNS and FACP systems may use either one strobe (clear) or two strobes (clear for fire and amber for MNS) as specified by the AHJ. Text signs may be required by the AHJ over the door to each egress stairwell and over (or adjacent to) the substantial means of egress from the level of discharge. Exterior exit doors from a single room (e.g., mechanical or electrical rooms) do not require a text sign.

5-4.4.2.1 Army and Air Force installations shall use existing clear/white strobes for fire and install amber strobes for MNS. New amber strobes will be marked with word "ALERT." Installation of text signs is optional and at the discretion of the DOD installation.

\1\ 5-4.4.2.2 Navy installations shall use clear/white strobes marked with the word "ALERT." Text signs shall be located over the door to each egress stairwell and over (or adjacent to) the substantial means of egress from the level of discharge. Exterior doors from a single room (e.g., mechanical or electrical rooms) do not require a text sign. /1/

\1\ 5-4.4.2.3 /1/ Marine Corps installations shall contact the AHJ for guidance on visual notification appliances.

5-4.5 Interfaces with Facility FACP. The MNS shall provide the capability (either internally as a design feature, or with an approved or listed external controller) to temporarily deactivate the facility's fire alarm system audible and visual notification appliances. This is intended to allow the MNS to provide intelligible voice commands

inside an individual building during simultaneous fire and terrorist events. System features are provided to compensate for the increased risk from fire in these cases.

SE Marine Corps MNS designs may interface with the facility FACP. Contact the AHJ for guidance.

5-4.6 Interfaces with Facility PA System. The use of the speakers and other components in the existing PA system may be appropriate in smaller size buildings in which the installation of a new speaker system is not cost effective and the existing PA system is new or relatively new, in excellent condition, and of relatively simple design. If this implementation approach is taken, an ACU must be interfaced with the existing PA system. The existing PA system must be tested to demonstrate acceptable intelligibility of the voice messages, and additional speakers must be added as required. These features must be provided in or added to the PA system:

- Emergency messages must have priority over non-emergency messages.
- All individual or zone speaker volume controls must default to the emergency sound level when used for an MNS message.
- Provide a supervisory signal when the PA system has been placed in the “OFF” condition.
- When monitoring of circuit integrity is provided by the PA system, continue monitoring even if local speaker volume controls are placed in the “OFF” position.
- Provide the required visual notification appliance network (i.e., strobes and text signs).

SE Marine Corps MNS designs are not required to provide an interface with the facility PA system.

Note: The term “public address system” (or “PA system”) is used in this UFC to mean both PA and intercommunication systems.

5-4.7 Interfaces with the Wide Area MNS. If a wide area MNS is provided on the DOD installation, the individual building MNS communicates with the central control units of the wide area MNS to provide status information, receive commands, activate pre-recorded messages, and originate live voice messages. Depending on system architecture, the manufacturer may be required to provide a system IP interface capable of allowing data transfer from an outside source to internal mass notification functions via a common data communications protocol.

SE Marine Corps MNS designs shall interconnect the wide area MNS with the individual building MNS through the use of common control systems.

Note: When a wide area MNS is provided on the DOD installation, the system manufacturer should provide a standard method (such as an audio line-level output and multiple relay contacts) or supply the necessary digital communication protocols to permit the DOD installation to select more than one manufacturer of individual building MNS.

5-4.8 **Logical Block Diagrams.** Figures 5-1 through 5-7 show the logical block diagrams for acceptable configurations of the individual building MNS for renovation projects, including the installation of MNS in existing buildings.

Note: These diagrams are intended to show only the functional relationships of major components. The diagrams are not intended to serve as wiring diagrams. Many essential design features for an operational system, such as end-of-line resistors, are not shown.

**Figure 5-1. Individual Building Mass Notification System:
Separate Fire Alarm System and MNS
(Navy)**

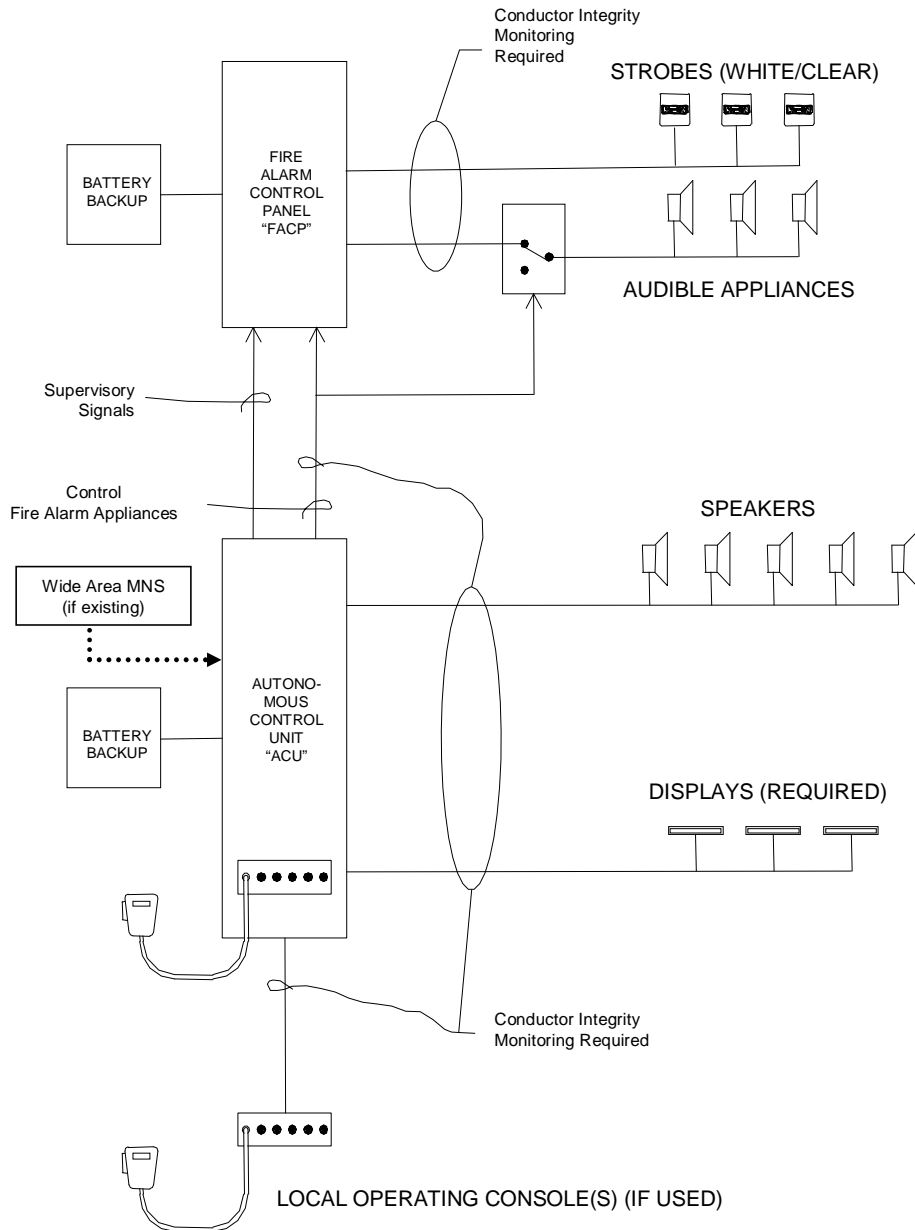

**Figure 5-2. Individual Building Mass Notification System:
Separate Fire Alarm System and MNS
(Army and Air Force)**

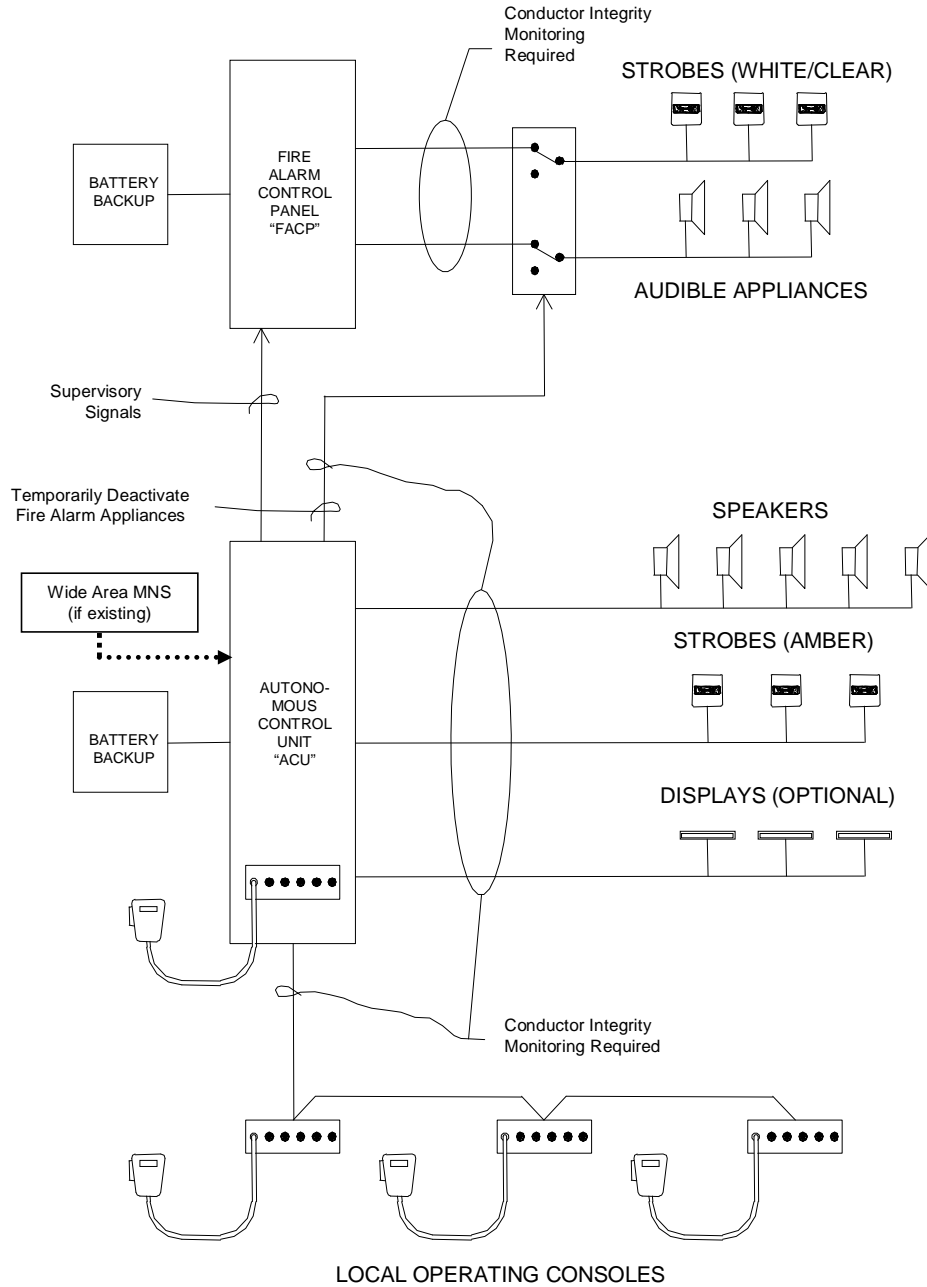

**Figure 5-3. Individual Building Mass Notification System:
 Separate Fire Alarm System and MNS
 (Marine Corps)**

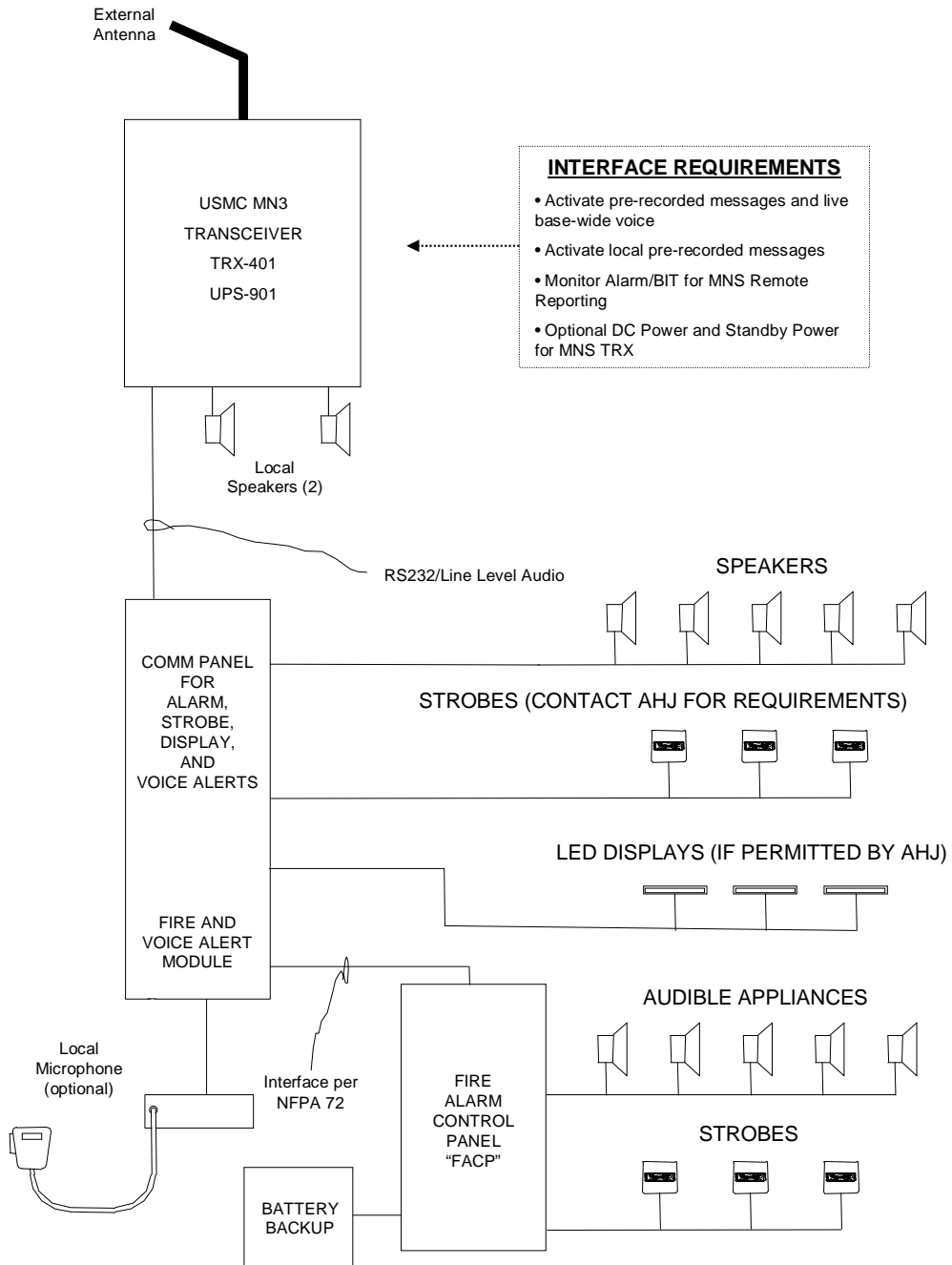

**Figure 5-4. Individual Building Mass Notification System:
Speakers Shared by Fire Alarm System and MNS
(Navy)**

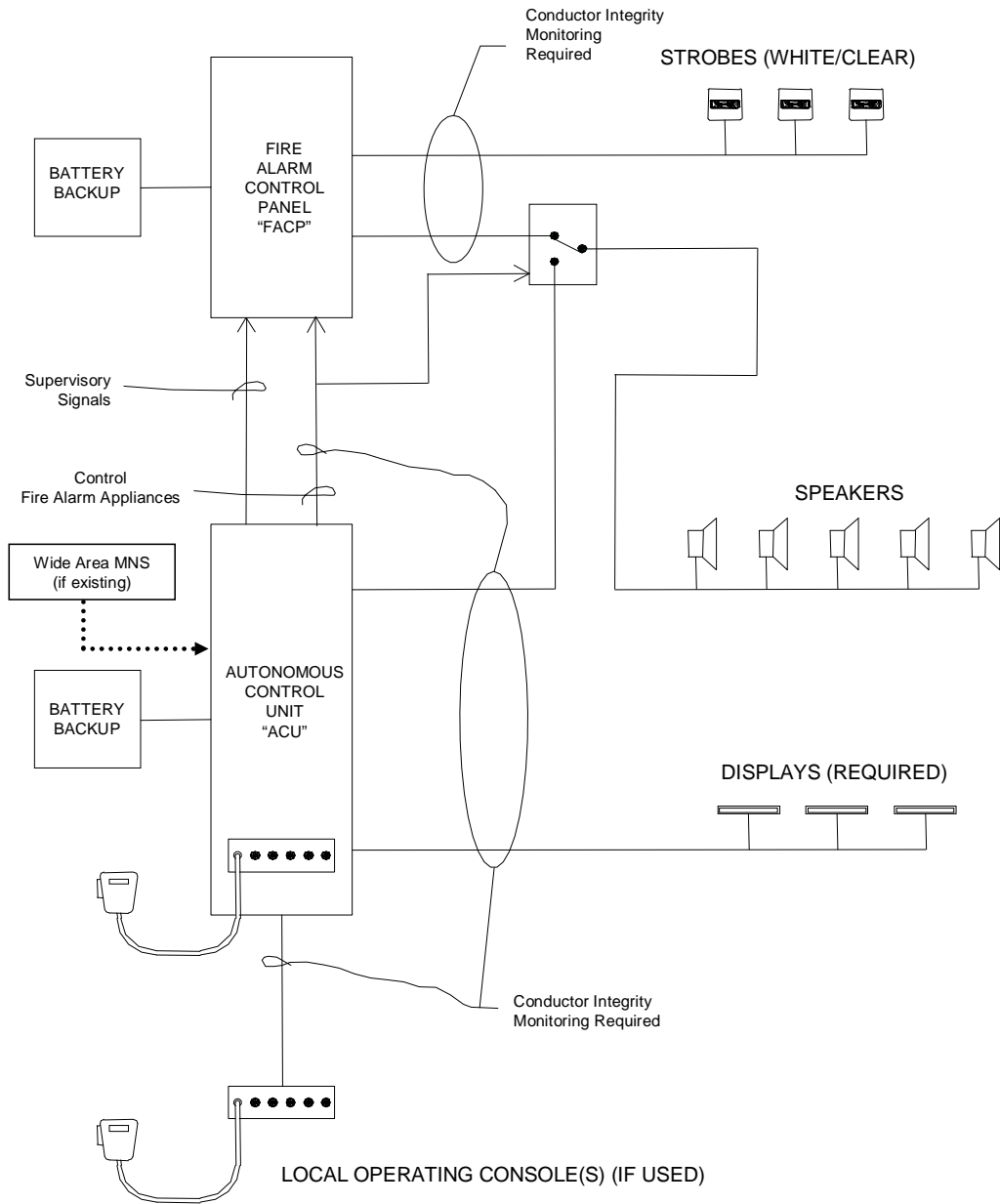

**Figure 5-5. Individual Building Mass Notification System:
Speakers Shared by Fire Alarm System and MNS
(Army and Air Force)**

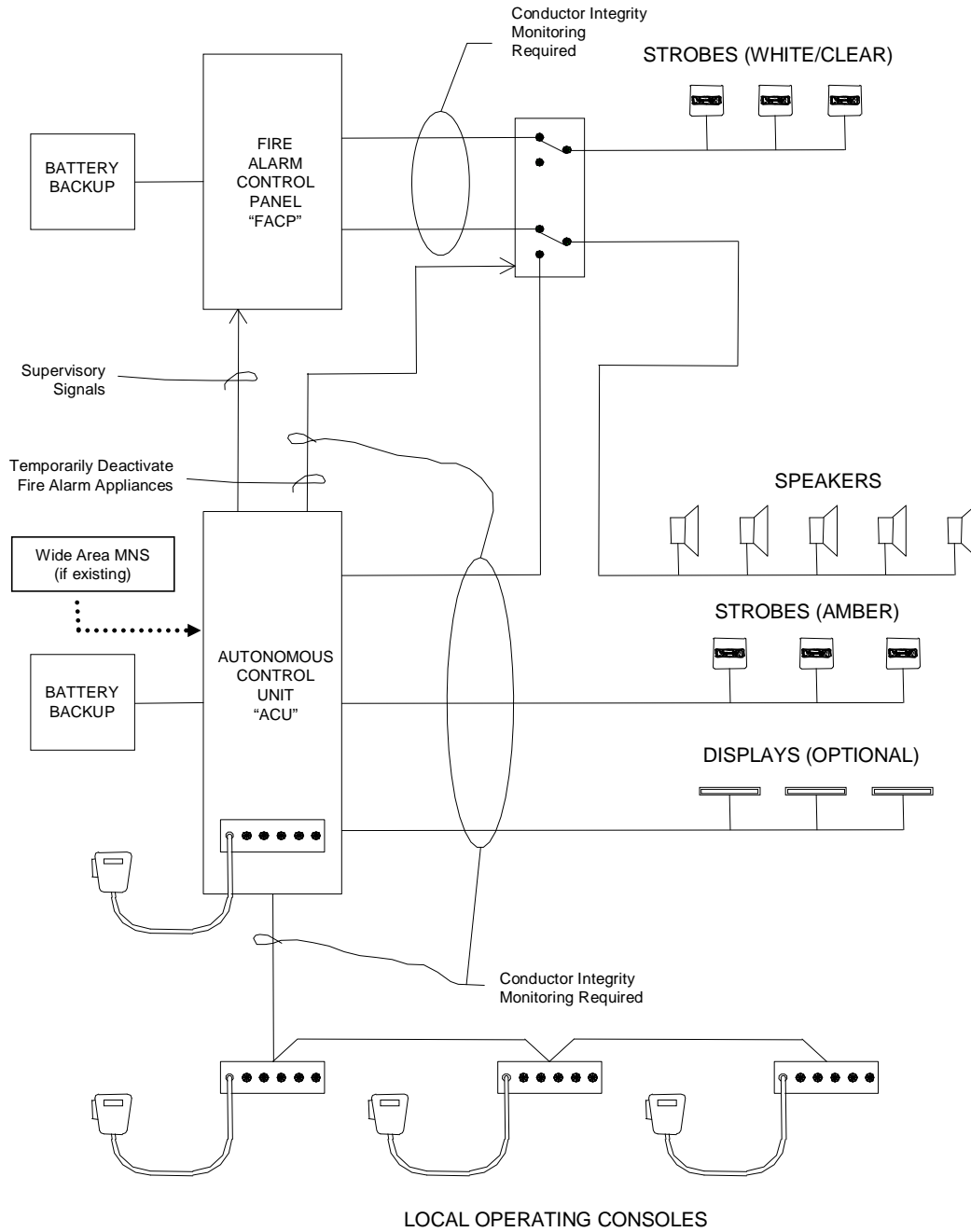

Figure 5-6. Use of Existing Public Address System: Navy

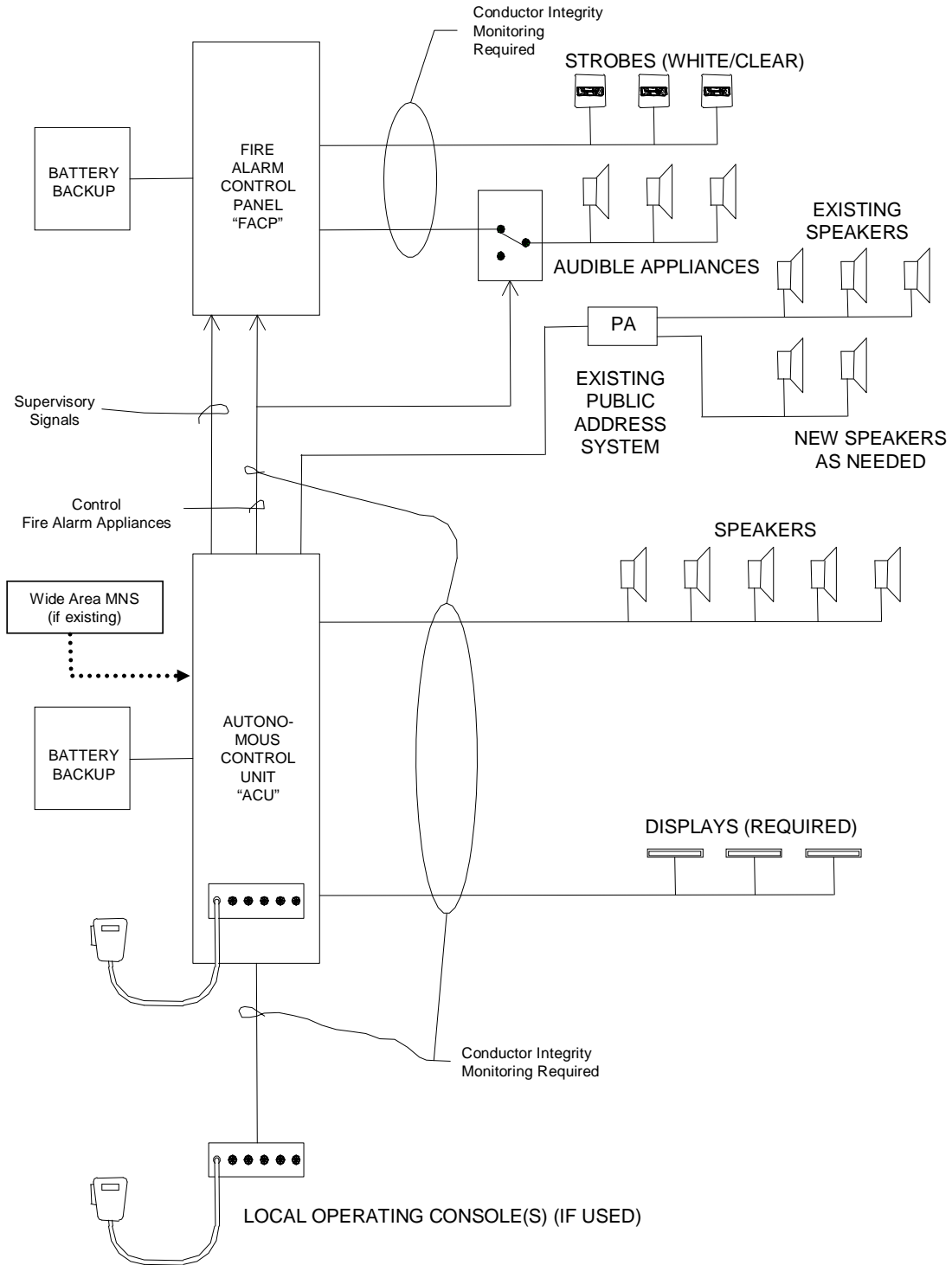
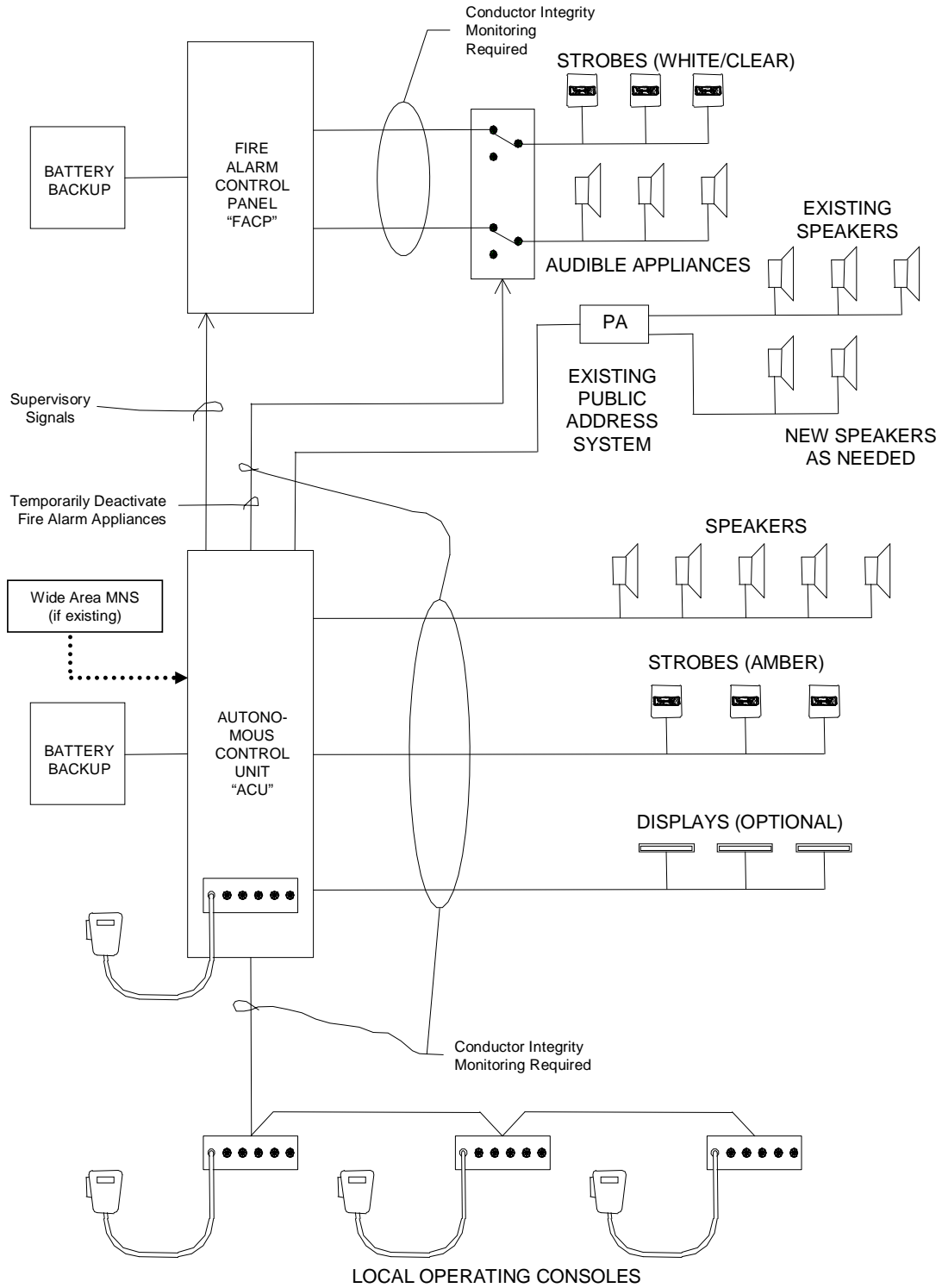

Figure 5-7. Use of Existing Public Address System:
Army and Air Force



5-5 **ACU**

5-5.1 **Location.** Install the ACU at the location normally specified by the DOD component AHJ for a stand-alone FACP.

5-5.2 **Design Features.** The ACU shall:

- Be able to function independently upon failure of the wide area MNS (if provided on the DOD installation).
- Meet UL Standard 864 or UL Standard 2017, and meet the MNS requirements in NFPA 72 and the specific requirements of this UFC. The listing evaluation shall be accomplished by UL, FM, or another NRTL.
- Be able to activate strobes and text signs:
 - Navy: Energize LED-type text signs. Text signs are required over the door to each egress stairwell and over (or adjacent to) the substantial means of egress from the level of discharge. Exterior exit doors from a single room (e.g., mechanical or electrical rooms) do not require a text sign.
 - Marine Corps: Contact the AHJ for guidance on visual notification appliances.
 - Army and Air Force: Energize a set of amber strobe lights marked “ALERT” for the MNS. Simultaneously de-energize clear/white strobe lights used by the fire alarm system. Energize LED-type text signs if required by the DOD installation.
- Make general paging or other non-emergency messages available without the activation of strobes. A separate microphone must be provided for this purpose.
- Be able to interrupt PA system announcements and to silence building background music while delivering voice messages.
- Be able to accept voice messages from the DOD installation telephone system.
- Have conductor connections that comply with NFPA 72.
- **Note:** Ethernet or IP connections for initiating and indicating circuits are not currently available that will meet NFPA 72 requirements and, therefore, may not be used. Additionally, all software and hardware to be installed on DOD Ethernet or Internet systems must first successfully complete an accreditation process. Accreditation often takes a relatively long time.

- Have conductor integrity monitoring for strobes, speaker wiring, power supplies, and connections to LOC.
- Be able to switch between MNS and fire alarm notification functions without generating trouble alarms in either system.
- Have the capacity for multiple pre-recorded messages (at least eight, but more if required by the DOD installation). Pre-recorded messages shall be passed in the English language and, for OCONUS locations, also in the predominant language(s) used by the host nation. Pre-recorded messages, if used, should address at least these subjects:
 - Bomb threat or actual bomb within/around the building
 - Intruder/hostile person sighted within/around the building
 - Directions to occupants to take cover within the building
 - Evacuation of the building using exits other than the normal main entrance/exit (since the front entrance/exit is often a location targeted by terrorists)
 - Emergency weather conditions appropriate for the local area
 - “All Clear” message
 - A test message intended for verifying functionality of the system

 Marine Corps AHJ will determine the number and content of pre-recorded messages.

- \1\ Provide an alerting sound prior to playing pre-recorded messages. The alerting sound for fire alarm messages shall be different than that used for other pre-recorded messages. The fire alarm alerting sound for buildings other than child development centers shall be either the temporal three-tone or the slow whoop for fire alarm messages, unless otherwise approved by the approving authority (i.e., the AHJ for the Navy and Marine Corps; the DOD installation in conjunction with the contracting officer for the Army and Air Force). The fire alarm alerting sound for child development centers shall be a chime sound. /1/
- Be able to deliver messages quickly.
- Be able to automatically repeat pre-recorded messages until they are terminated.
- Have a microphone for delivering live voice messages.

- Provide adequate discrete outputs to initiate text signs and MNS strobes, and de-energize fire alarm strobes.
- Interface to the LOC for initiating recorded messages and delivering live voice messages from locations in the building other than at the ACU.
- Establish priority for passing messages to prevent interference between the ACU, LOC, and the wide area MNS on the DOD installation.
- Interface with the FACP to override fire alarm audible and visual notification appliances. The FACP shall provide supervised circuit integrity of interconnecting wiring between the MNS and FACP.
- Allow the MNS to temporarily override fire alarm audible messages and visual signals, and to provide intelligible voice commands during simultaneous fire and terrorist events. All other features of the fire alarm system, including the transmission of signals to the fire department, shall function properly. MNS messages shall take priority and continue to override fire alarm audible messages until the MNS message is either manually or automatically ended. If not manually ended, the MNS message will automatically end after 10 minutes.
- Provide a supervisory signal if the MNS is used to override fire alarm audible messages and visible signals during simultaneous fire and terrorist events. The supervisory signal shall be annunciated at the FACP and any remote fire alarm annunciators, and be transmitted to the fire department. The visual annunciation of the separate supervisory signal shall be distinctly labeled or otherwise clearly identified.

SE The Army requires that this supervisory signal be separate from other fire alarm system supervisory signals.

- Provide remote monitoring of trouble, supervisory, and alarm functions to a constantly occupied location. This may be the same location that receives fire alarm system signals or to the central control units of the wide area MNS on the DOD installation.
- Provide a single switch or operating mechanism capable of shutting down all HVAC equipment in the facility in accordance with the requirements of UFC 4-010-01. If permitted by the DOD installation, this shutdown capability may be provided at a LOC or be deleted entirely if the capability is otherwise provided at a location readily accessible to building occupants.
- Provide a complete set of self-diagnostics for the controller and appliance network.
- Have a local diagnostic information display.

- Have a local system event log file.

5-5.3 **Off-the-Shelf Equipment.** ACU equipment furnished as part of the individual building MNS shall be COTS and shall be tested to the standards of UL or FM by a NRTL.

5-5.4 **Programming Codes.** All programming codes or passwords required to access, update, modify, and maintain the ACU shall be provided to the DOD installation no later than the date of final system acceptance.

5-5.5 **Power Supply Features.** The power supply shall:

- Be capable of accepting 120/240 VAC, 50/60 Hz.
- Be appropriate for a MNS that meets at least the minimum NFPA 72 requirements for standby power capacity. In addition, secondary (standby) power should be provided as follows: immediately upon loss of normal AC power, the standby source of power shall provide a minimum of 60 minutes of mass notification at the maximum connected load.
- Disable use of any microphones intended solely for general paging or other non-emergency messages upon loss of normal AC power.
- Conform to applicable sections of NFPA 72.
- Use only COTS components.
- Provide surge protection in accordance with UFC 3-520-01.

5-6 **LOC**

5-6.1 **Locations.** Provide LOC to allow emergency response forces and building occupants to access the MNS and originate messages in emergency situations from locations in the building other than from the ACU. Follow these requirements:

- Provide a separate LOC for use by the fire department near the building FACP (or fire command center) unless this is also the location of the ACU.
- Do not place a LOC inside of locked rooms or closets (with the possible exception of the LOC intended for use by the fire department near the FACP).
- Install LOC at those facility entrances/exits that will be used when building access is limited because of elevated terrorism threat levels.

Note: This LOC is intended to enable immediate notification of building occupants when unauthorized building access is threatened or has occurred at this location.

- Army and Air Force: Provide a LOC so that occupants do not need to travel a distance in excess of 61 m (200 ft) horizontally or to travel to other floors to access a LOC.
- Army and Air Force: Make LOC available for use by visitors in those facilities open to unescorted visitors or to the public.
- Navy: Provide no more than one LOC (if necessary) in addition to the ACU. Locate the LOC as directed by the responsible fire protection engineer.
- Marine Corps: Provide no more than one LOC (if necessary) in addition to the ACU. Locate the LOC as directed by the AHJ.

5-6.2 **Design Features.** The LOC shall:

- Have a remote microphone station that emulates operation of the MNS from the ACU.
- Have an easy method (such as individual manual activation push buttons) of activating the MNS pre-recorded messages. Signage shall be provided to allow rapid recognition of the means of initiating the pre-recorded messages.

SE Activation of MNS pre-recorded messages is not required for Marine Corps LOC.

- Provide a single switch or operating mechanism capable of shutting down all HVAC equipment in the facility in accordance with the requirements of UFC 4-010-01. If permitted by the DOD installation, this shutdown capability may be provided at only one LOC when multiple LOCs are installed, or be deleted from all LOCs if the capability is otherwise provided at a location readily accessible to building occupants.
- Be protected in a small, wall-mounted enclosure.
- Have supplemental heating and ventilation for those enclosures located outdoors or in areas where the LOC will be exposed to temperatures or humidity outside of the manufacturer's design limits.
- Be protected from tampering by use of a break-glass, thumb-lock, tamper wire, tamper alarm, or equivalent protection. This is not required in those facilities with limited access so that unauthorized use would not reasonably be expected to occur. Enclosures that can be opened only by a key shall not be used.

SE Marine Corps LOC may use key-operated locks when emergency response forces are provided with immediate access (e.g., master key, Knox-box®)

- Have signage on the outside of the enclosure similar to “Mass Notification” and “HVAC Emergency Shutdown” (if applicable).

5-7 NOTIFICATION APPLIANCE NETWORK

Note: Also see paragraph 6-5 for notification appliance requirements in special occupancies.

5-7.1 **Audible Appliance Network.** These are the requirements for the audible appliance network:

- Provide appliances capable of satisfying \1\ ABAAG /1/.
- Use speakers suitable for the intended climatic and environmental conditions.
- Use speakers suitable for installation in commercial/industrial applications with consideration of electrically hazardous (classified) locations.
- Provide speakers and installation methods compliant with DCID 6/9 for areas classified as SCIF.
- Network design shall comply with NFPA 72.
- Speakers shall meet the listing requirements of UL Standard 1480.
- Provide speakers at all locations inside a building where the building fire alarm must be audible.
- \1\ Ensure speakers in the vicinity of the ACU and LOC will not create acoustical feedback or otherwise interfere with the ability to deliver live voice messages. /1/
- Provide speakers mounted on the exterior of the building to provide notification of any areas commonly used by building occupants. These include courtyards, covered break areas, designated smoking areas, and sidewalks leading from the building’s exit doors to a public street or from parking areas for a distance up to 5 m (16 ft) from the building. Use speakers with directional characteristics that transmit minimal backplane noise when mounted on the sides of the building. Generally, the speakers should be located near entrance/exit doors.
- Provide an effective voice communication within buildings using a design including many speakers, each with low audio intensity.
- Install speakers with field-adjustable tap settings to allow adjustment after installation to meet audibility and intelligibility requirements.

- Do not use speakers exceeding 15 W for indoor applications without prior approval of the AHJ.

5-7.1.1 **Speaker Design Recommendations**

- Speakers rated at 2 W or less and provided with multiple tap settings to adjust the output power can often provide acceptable sound quality in most occupied areas.
- Speakers rated at 8 W or less and provided with multiple tap settings can often provide acceptable sound quality for most large or very noisy areas.
- Speakers rated at 8 to 10 W for interior distribution should be used when the speakers are also intended to meet the better sound quality normally expected from PA systems. These speakers should be capable of a frequency response over the range of at least 200 to 10,000 Hz.

Note: Such speakers are often adjusted to operate at a tap setting of 2 W or less, but are used because their sound quality is greatly superior to the small speakers typically used in fire alarm systems.

- Wiring methods shall comply with NFPA 72. Class B wiring is permitted unless Class A wiring is required for fire alarms systems on the DOD installation.

5-7.1.2 **Intelligibility Requirements**

- Verify intelligibility by measurement after installation.
- Ensure that a CIS value greater than the required minimum value is provided in each area where building occupants typically could be found. The minimum required value for Navy and Marine Corps is 0.7 CIS. The minimum required value for Army and Air Force is 0.8 CIS, although rounding is permitted such that a value of 0.75 may be rounded to 0.8.
- Areas of the building provided with hard wall and ceiling surfaces (such as metal or concrete) that are found to cause excessive sound reflections may be permitted to have a CIS score less than the minimum required value if approved by the DOD installation, and if building occupants in these areas can determine that a voice signal is being broadcast and they must walk no more than 10 m (33 ft) to find a location with at least the minimum required CIS value within the same area.
- Areas of the building where occupants are not expected to be normally present are permitted to have a CIS score less than the minimum required value if personnel can determine that a voice signal is being broadcast and they must walk no more than 15 m (50 ft) to a location with at least the

minimum required CIS value within the same area. /1/

- Measurements should be taken near the head level applicable for most personnel in the space under normal conditions (e.g., standing, sitting, sleeping, as appropriate).
- \1\ The distance the occupant must walk to the location meeting the minimum required CIS value shall be measured on the floor or other walking surface as follows:
 - Along the centerline of the natural path of travel, starting from any point subject to occupancy with less than the minimum required CIS value.
 - Curving around any corners or obstructions, with a 300-mm (12 in.) clearance therefrom.
 - Terminating directly below the location where the minimum required CIS value has been obtained. /1/
- Commercially available test instrumentation shall be used to measure intelligibility as specified by IEC 60849 and IEC 60268-16. The mean value of at least three readings shall be used to compute the intelligibility score at each test location.
- \1\ Occasionally, large DOD buildings are designed to provide cavernous-type open areas to meet unique operational requirements. Such areas are typically designed with hard wall and ceiling surfaces (such as metal or concrete) without acoustical treatments, and this has been found to cause excessive sound reflections that prevent obtaining the normal, minimum required CIS value. In such facilities, the cavernous-type open area is permitted to have locations with a CIS value lower than the normal, minimum required CIS value when the following conditions are met:
 - The requirement for a deviation from the normal, minimum CIS criteria is identified in the design phase.
 - Justification for the deviation from the normal, minimum CIS criteria is provided to the approving authority (i.e., the AHJ for the Navy and Marine Corps; the DOD installation in conjunction with the contracting officer for the Army and Air Force). The justification shall address all factors relevant to the request for deviation from normal, minimum CIS criteria, including, but not limited to: the operational requirements that restrict the installation of acoustical wall and ceiling treatments; the potential use of special speaker technologies such as directional speakers or stacked speaker systems; and the availability of physically larger or higher-fidelity speakers even though such speakers might not be listed for fire alarm use.

Note: Deviation from normal, minimum CIS criteria should not be requested for the design of normal, large, open areas that are typically found in permanent DOD buildings, such as dining halls, theaters, and gymnasiums. The potential for deviation from normal criteria is intended to address the rare exception to normal criteria that is sometimes needed for DOD buildings with unique operational requirements.

- Building occupants located in the large, cavernous area can adequately understand the message content in the voice signal being broadcast. Whether the voice message is adequately understood shall be determined by the approving authority (i.e., the AHJ for the Navy and Marine Corps; the DOD installation in conjunction with the contracting officer for the Army and Air Force).
- The CIS value is not less than 0.6 at any location within the large, cavernous area.
- The building occupants in the large, cavernous area must walk no more than 30 m (98 ft) to find another location within the large, cavernous area having at least the normal, minimum required CIS value. /1/

Note: An STI score of 0.5 is considered equivalent to a CIS score of 0.7. \1\ An STI value of 0.7 is considered equivalent to a CIS value of 0.8. /1/

5-7.1.3 \1\ DELETED /1/

5-7.2 **Visual Appliance Network.** These are the requirements for the visual appliance network:

- Provide visual appliances capable of satisfying all \1\ ABAAG. /1/
- Use visual appliances suitable for the intended climatic and environmental conditions.
- Use visual appliances suitable for installation in commercial/industrial applications with consideration of electrically hazardous (classified) locations.
- Strobes shall meet the listing requirements of UL Standards 1638 and 1971. Text signs shall comply with UL Standard 48.
- Strobes are not required outside the building.
- Where more than two visible notification appliances are in any field of view, they shall flash in synchronization.
- Wiring methods shall comply with NFPA 72. Class B wiring is permitted unless required otherwise by the local AHJ.

5-7.2.1 **Navy-Specific Requirements**

- Provide clear strobes marked with the word “ALERT” for shared use by the facility’s MNS and FACP.
- Provide LED text signs. Text signs are required over the door to each egress stairwell and over (or adjacent to) the substantial means of egress from the level of discharge. Exterior exit doors from a single room (e.g., mechanical or electrical rooms) do not require a text sign. (See Chapter 7 for operational requirements and information on message content.)

5-7.2.2 **Marine Corps-Specific Requirements**

- Contact the AHJ for guidance on visual notification appliances.

5-7.2.3 **Army- and Air Force-Specific Requirements**

- Provide amber-colored strobes marked with the word “ALERT” to alert the hearing impaired. Provide these strobes in addition to existing clear strobes provided for the building fire alarm system.
- Amber strobes activated in conjunction with the delivery of a pre-recorded voice message shall operate continuously until message termination. Amber strobes activated in conjunction with the delivery of a live voice message shall operate during the message and for not less than 15 seconds after the message ends.
- Clear/white strobes activated by the fire alarm system shall not operate during those periods when the amber strobes are in operation, but otherwise shall operate continuously until the fire alarm system is reset.

5-8 **INTERFACES WITH WIDE AREA MNS.** The individual building MNS shall be capable of interfacing with an existing wide area MNS. If a wide area MNS is not presently provided on the DOD installation, the individual building MNS shall be designed to allow future interface with a wide area MNS procured from another manufacturer. The electrical requirements, computer codes, or other protocols that are needed to interface the systems shall be provided to the DOD installation. At a minimum, the wide area MNS shall be able to provide and the individual building MNS shall be able to receive an audio line-level input. The individual building MNS shall not be activated or controlled by a giant voice system unless the giant voice system also meets the design and performance requirements of a wide area MNS.

CHAPTER 6

SPECIAL CONSIDERATIONS

6-1 **OVERVIEW.** DOD requirements for antiterrorism mandate the installation of individual building MNS during new construction and renovation projects. These systems are presently being installed on most DOD installations. Although not required by the DOD, use of a wide area MNS may be an important part of the antiterrorism strategy established by DOD installations.

6-2 **IMPLEMENTATION PLAN.** Each DOD installation should establish an implementation plan that establishes a comprehensive approach to MNS that is acceptable to security, communications, and fire protection engineering personnel. Elements of an implementation plan should include a needs assessment, requirements definition, alternatives evaluation, system selection, and implementation schedule. Some DOD installations may choose to first select and install a wide area MNS and subsequently install an individual building MNS that is compatible with the wide area MNS. This is not required by the DOD but will immediately increase the readiness of the DOD installation to respond to terrorist and other threats. Other DOD installations may choose to install individual building MNS in new construction and renovation projects, and also in their most significant and important facilities. This approach will spread the cost of installation over a longer time. The completed implementation plan will serve as a roadmap to address the specific needs and unique circumstances associated with each particular DOD installation.

6-3 **GIANT VOICE SYSTEM.** Some DOD installations are currently provided with a giant voice system for outdoor notification. Many of these systems were designed in the Cold War era and were intended to transmit tones signals, not voice signals. These systems may not adequately provide intelligible voice signals over much of the DOD installation. Closer spaced and less powerful speaker arrays are often required to achieve adequate intelligibility. Existing giant voice systems often have proved unsatisfactory in providing intelligible messages between multi-story buildings in high population density areas (such as industrial areas). Newer speaker technologies are available and should be considered for installation in these areas. Additionally, this UFC does not permit the use of giant voice systems inside of buildings because of the difficulty in achieving acceptable intelligibility of voice messages, the need to monitor circuit integrity, and the requirement to provide visual notification appliances for persons with hearing disabilities. This UFC does not permit an existing giant voice system to activate or control an individual building MNS unless the giant voice system fully complies with the requirements for a wide area MNS.

6-4 **TELEPHONE ALERTING SYSTEM.** A telephone alerting system may be useful in supplementing a wide area MNS and providing notification to building occupants where mass notification would not be required by UFC 4-010-01, such as in small facilities with only a few occupants and single-family and duplex military family housing. Telephone alerting system services are sometimes outsourced to reduce the

operation and maintenance burden on the base; however, outsourcing increases reliance on systems not under direct control of the facility being serviced and could impact the reliability or vulnerability of the telephone system capability.

6-5 SPECIAL OCCUPANCIES

6-5.1 **No Self-Preservation Capability.** This UFC does not require the installation of mass notification capability for those persons who are unable to protect themselves and could not take action without the assistance of others. Examples include prisoners in correctional facilities that are physically prevented from taking action or patients in a hospital that require assistance from the medical staff to take action. Mass notification capability is still required for the staff of these facilities so they may know to take action to protect themselves and those in their care. The appropriate approach for these facilities is to emulate the design solution that would be applied in that building for the installation of a new fire alarm system.

SE Individual building MNS for Marine Corps projects shall serve as a subsystem of the wide area MNS as described in chapters 3 and 5.

6-5.2 **Not Occupied by Hearing Impaired Persons.** This UFC does not require the installation of visual notification signals in areas not subject to occupancy by persons who are hearing impaired, except that visual notification signals shall be provided in areas where hearing protection is worn due to high ambient noise levels.

Note: Visual notification signals must be provided even if the area is only accessed occasionally by personnel who are hearing impaired and granted unaccompanied access, such as maintenance or cleaning personnel, except for those areas listed in section 6-5.3.

6-5.3 **Housing and Lodging Facilities.** When MNS is required for personnel housing (such as barracks, dormitories, lodges, temporary or transient living facilities, and other sleeping quarters with 11 or more unaccompanied persons) or for military family housing (such as 13 or more family units in one building), audible and visible MNS appliances shall be provided.

6-5.3.1 Audible appliances, including in sleeping areas, shall provide a sound level of at least 15 dBA above the average ambient sound level and at least 5 dBA above the maximum sound level having a duration of at least 60 seconds, and they shall provide a CIS score equal to or greater than 0.7 (Navy and Marine Corps) or 0.8 (Army and Air Force). Sleeping areas shall also be provided with a minimum sound level of 75 dBA unless a CIS score equal to or greater than 0.7 (Navy and Marine Corps) or 0.8 (Army and Air Force) is provided.

6-5.3.2 Visual appliances are not required within private living and sleeping rooms except those that are specifically designated by the DOD installation for the accommodation of hearing-impaired individuals. Visual notification appliances shall be provided in other general usage areas such as common rooms, day rooms, meeting

rooms, hallways, corridors, lobbies, and public restrooms.

CHAPTER 7

OPERATIONAL CHARACTERISTICS

7-1 **INTRODUCTION.** This chapter provides a description of the most significant operating characteristics of wide area MNS and individual building MNS.

7-2 **WIDE AREA MNS**

7-2.1 **Central Control Stations.** A primary and backup central control station are provided. At each central control station, a computer with a GUI is provided. With the GUI, the system operator can send live voice signals using a microphone and can send or activate pre-recorded voice signals, tones, and music signals. The signals can be sent to individual buildings, zones of buildings, individual outdoor speaker arrays, zones of outdoor speaker arrays, or to the entire DOD installation. Different signals can be sent to different locations. The central control station can receive voice signals by telephone or radio and patch those signals through to desired locations on the DOD installation. Music, such as Reveille and the national anthem, can be transmitted throughout the DOD installation. The central control station automatically or manually assigns priorities to all transmitted signals.

7-2.2 **Regional or National Command Centers.** When required by the DOD component, those signals transmitted on the DOD installation that meet a screening criteria for priority are automatically relayed to a regional or national command center, or to nearby DOD installations that have a need to know of the emergency.

7-2.3 **Public Alert and Warning System.** This national system is under development by the Department of Homeland Security as directed by Executive Order 13407. DOD systems are required by this same Executive Order to coordinate with the national system. The wide area MNS will be designed with the capability to receive, record, and distribute voice messages and alert signals received from the Commander-in-Chief through the national public alert and warning system. This will permit the central control station to immediately distribute the voice messages or alert signals, or to delay the distribution as necessary to meet operational requirements as approved by the DOD installation commander.

7-2.4 **HPSA.** Designated HPSAs are provided with a microphone to enable an on-scene commander, security forces, or others (such as a drill instructor) to use the HPSA for local announcements and instructions. In some cases, individual speakers or all speakers of these arrays may be locally selected and energized. The speakers for these arrays will be highly directional when designed to permit operation from a location directly below the speakers without feedback or harmful sound pressure levels.

7-2.5 **Supplemental Mass Notification Delivery Systems.** The wide area MNS can also interface with and control other notification systems such as telephone dialers, tone alert systems, computer network alerting systems, pagers, facsimile machines, and vehicular traffic directional control signs. Text notification via wireless devices and

desktop computer notification are effective means for delivering mass notification messages to multiple recipient groups. Wireless text messaging is effective in reaching off-base personnel. This is especially useful for OCONUS locations. Desktop notification is particularly effective when more complex information must be conveyed, and can be a cost-effective interim solution prior to installing an individual building MNS.

Note: See Appendix C for a discussion of requirements for Internet-based communication systems (under development).

7-3 INDIVIDUAL BUILDING MNS

7-3.1 **Combined Systems.** In new construction, mass notification and fire alarm functions are combined into one system. PA may also be combined into this system. In renovation projects, combined systems are preferred, but separate systems may be permitted in some applications. The mass notification functions can temporarily disable the fire alarm notification appliances to allow intelligible voice announcements when needed in the case of simultaneous terrorist and fire events. This is necessary because arson and unauthorized fire system activation are methods of attack that have been used previously by terrorists.

SE Individual building MNS for Marine Corps projects shall serve as a subsystem of the wide area MNS as described in Chapters 3 and 5, and might not interface with the fire alarm system.

7-3.2 **LOC.** These consoles are provided to allow building occupants and emergency response forces to operate the system and provide live voice or pre-recorded messages to personnel in the building. They also enable the building occupants to completely shut down the heating, ventilating, and air conditioning system as needed to respond to a terrorist event or external natural disaster. Army and Air Force systems permit most building occupants to access the LOC, and use tamper-resistant features to minimize unauthorized use. The Navy limits access to the LOC to emergency response forces and a few of the building occupants, such as the building manager, security staff, or the commanding officer's staff. The Marine Corps does not provide a LOC but does provide a remote microphone.

7-3.3 **ACU.** The ACU has the same capabilities to operate the system as a LOC, plus the ability to override or disable the mass notification capability. Access to the ACU is limited to emergency response personnel.

7-3.4 **Notification Appliances.** Speakers are used to provide intelligible voice signals for mass notification. Strobes are used to meet the accessibility requirements for those persons with hearing disabilities. The Army and Air Force use amber-colored strobes to alert those with hearing disabilities. The Navy uses one set of clear strobes for both fire and mass notification. These strobes are marked "ALERT" instead of "FIRE". The Navy also uses text signs to assist persons with hearing disabilities. These signs read "EVACUATE" when the fire alarm system is in alarm. The signs read "ANNOUNCEMENT" when a mass notification message is being transmitted, and the

text sign will continue for 10 seconds after the end of the announcement. Text signs are required over the door to each egress stairwell and over (or adjacent to) the substantial means of egress from the level of discharge. Exterior exit doors from a single room (e.g., mechanical or electrical rooms) do not require a text sign.

Note: The Marine Corps uses notification appliances as specified by the AHJ.

CHAPTER 8

MAINTENANCE

8-1 **INTRODUCTION.** This chapter was developed on the basis of recommendations from MNS manufacturers, as well as experience with similar computer-based systems. Maintenance requirements established for each MNS must consider the manufacturer's maintenance recommendations and the applicable DOD maintenance requirements. MNS shall be maintained so that they comply with the minimum operating parameters recommended by the manufacturer.

8-2 **MAINTENANCE RESPONSIBILITIES.** DOD components that have assigned maintenance responsibilities include:

8-2.1 **Air Force.** Air Force communications squadrons are responsible for maintaining giant voice systems in accordance with AFI 21-116 on Air Force installations. Civil engineering squadrons are usually responsible for maintaining individual building MNS on Air Force installations that are designed and installed in accordance with this UFC.

8-2.2 **Marine Corps.** Headquarters Marine Corps (HQMC) Technical Service Agency is responsible for maintaining the MNS across the Marine Corps.

8-3 **QUALIFICATIONS OF MAINTENANCE PERSONNEL**

8-3.1 **Inspection, Testing, and Maintenance Tasks.** Only personnel trained and qualified in maintaining and repairing MNS will perform inspection, testing, and maintenance tasks. Most types of MNS use technology commonly found in fire alarm systems, giant voice, or other outdoor voice and siren warning systems, and similar maintenance skills are needed. If specific manufacturer training is available, maintenance personnel must satisfactorily complete the training to be considered qualified. If specific manufacturer training is not available for a MNS, personnel shall be considered qualified if they have achieved a NICET Level III in fire alarm systems or in low-voltage electronic communication systems, or have achieved the UL certification level for fire alarm systems. Tasks must be performed according to the manufacturer's instructions. Certain jurisdictions may require varying levels of continuing education to maintain recognized qualifications. Overseas locations should contact their command fire protection engineering office for guidance on appropriate qualifications. Military personnel who have satisfactorily completed the required schools in their career field in fire detection and alarm system maintenance or communications electronics are considered qualified.

8-3.2 **Other Inspections.** This UFC lists inspection tasks that must be performed during regularly scheduled facility inspections. Fire prevention, safety, and maintenance personnel, as well as other individuals familiar with MNS operations, shall perform these inspection tasks.

8-3.3 **Maintenance Records.** Each DOD installation must maintain a permanent record of completed inspection, testing, and maintenance tasks in accordance with each agency's program for record keeping of recurring facility maintenance. Records may be hard copy or electronic. Where no DOD component-wide programs exist, records should be developed locally. Records must be maintained for every facility and must include, as a minimum, each task, the date scheduled, the date completed, and the name of the person completing the task.

8-4 **INDIVIDUAL BUILDING MNS.** See UFC 3-600-02, paragraph 2-2.2, "Fire Detection and Alarm Systems," for applicable guidance on inspecting, testing, and maintaining engineered protection features in DOD facilities.

8-5 **WIDE AREA MNS.** Tables 8-1 and 8-2 provide maintenance information for the central control unit and communications network for a wide area MNS.

Table 8-1. Central Control Unit Maintenance

Frequency	Component	Tasks
Weekly	Central control unit, diagnostic log files	<ul style="list-style-type: none"> • Review the event log file; verify that the correct events were logged. • Review the system diagnostic log file; correct deficiencies noted in the file.
	Central control unit, hard drive	<ul style="list-style-type: none"> • Delete unneeded log files. • Delete unneeded error files. • Verify that sufficient free disk space is available.
	System – Functional test	Send out an alert to a small set of pre-designated receiving devices and confirm receipt.
	System – Security	If remote control software is loaded onto the system, verify that it is disabled to prevent unauthorized system access.

Frequency	Component	Tasks
Monthly	System – Functional test	Send out an alert to a diverse set of pre-designated receiving devices and confirm receipt. Include at least one of each type of receiving device.
	Central control unit, reset	Power down the central control unit computer and restart it.
Quarterly	System – Software backups	Make a full system software backup. Rotate backups based on the accepted practice at the site.
	Central control unit, computer	<ul style="list-style-type: none"> • Verify proper operation of the computer. • Defragment the hard drive. • Verify unobstructed flow of cooling air. Clean filters. Remove dust buildup on cooling fans, cooling fins, and air intake vents.
	Central control unit, uninterruptible power supply (UPS)	<ul style="list-style-type: none"> • Verify that the system will operate in the absence of line power; discontinue line power to the system and verify functionality. • Test the UPS. See NFPA 70B.
Yearly	System – Software backups	Test the current software backup system by installing the system backup.
	Central control unit, operation	<ul style="list-style-type: none"> • Verify the content of pre-recorded messages. • Verify activation of the correct pre-recorded message based on a selected event. • Verify activation of the correct pre-recorded message based on a targeted area. • Verify that the central control unit security mechanism is functional.

Table 8-2. Communications Network Maintenance

Frequency	Component	Tasks
Weekly	Central control console	Verify that no diagnostic failures are indicated.
Monthly	HPSA/Wireless transceivers	Perform silent activation and/or health monitoring of all components.
	Total system functionality	<ul style="list-style-type: none"> • Perform a test system activation for a particular zone/building/area. • Verify that field components perform as expected.
Quarterly	Central control unit, UPS	<ul style="list-style-type: none"> • Verify that the system will operate in the absence of line power; discontinue line power to the system and verify functionality. • Test the UPS. See NFPA 70B.
Every 6 months	Field components	<ul style="list-style-type: none"> • Perform a visual inspection of all components. Verify that enclosure integrity is not compromised. • Perform a visual inspection of the antenna. Verify a solid connection and no corrosion. • Perform a visual inspection of the transceivers. Verify proper operation. • Generate a conductor integrity monitor alarm. Verify the alarm status on the central console. • Disconnect AC power. Verify the AC power failure alarm status on the central console. • Disconnect AC power. Verify the battery voltage under load.
Every 6 months	Wireless signals	Check forward/reflected radio power.

GLOSSARY

Acronyms and Abbreviations

\1\ **ABAAG**—Architectural Barriers Act Accessibility Guidelines /1/

AC—alternating current

ACU—Autonomous Control Unit

AFB—Air Force base

AFI—Air Force instruction

AHJ—authority having jurisdiction

ANSI—American National Standards Institute

APCO—Association of Public-Safety Communications Officials

C—Celsius

CAC—Common Access Card

CAP—common \1\ alert /1/ protocol

CD—compact disk

CIS—Common Intelligibility Scale

CNO—Chief of Naval Operations

CON—Certificate of Networthiness

CONOPS—concept of operations

CONUS—continental United States

COTS—commercial off-the-shelf

CSC-STD—DOD Computer Security Center Standard

CTO—Certificate to Operate

dBA—sound/noise power, adjusted, in decibels

DCID—Director of Central Intelligence Directive

DD—Department of Defense (as used on forms)

DIACAP—DOD Information Assurance Certification and Accreditation Process

DITSCAP—DOD Information Technology Security Certification and Accreditation Process

DOD—Department of Defense

EM—emergency management
EMWIN—Emergency Managers Weather Information Network
EOC—Emergency Operations Center
EPROM—erasable programmable read-only memory
F—Fahrenheit
FACP—fire alarm control panel
FCC—Federal Communications Commission
FEMA—Federal Emergency Management Agency
FM—Factory Mutual Research Corporation
FPCON—force protection condition
ft—feet
GPS—Global Positioning System
GUI—Graphical User Interface
HAZMAT—hazardous materials
HPSA—high power speaker array
HQ AFCESA/CEO—Air Force Civil Engineer Support Agency, \1\ Operations and Programs Support Division /1/
HQ DLA-D—Defense Logistics Agency Director
HQ DLA-DES-SE—Defense Logistics Agency, Support Services
HQ USACE/CECW-CE—U.S. Army Corps of Engineers, Directorate of Civil Works, Engineering and Construction
HQMC CODE PS—U.S. Marine Corps, Critical Infrastructure Assurance Branch
HVAC—heating, ventilation, air conditioning
Hz—hertz
ICC—Installation Control Center
IEC—International Electrotechnical Commission
INWS—Installation Notification and Warning System
IP—Internet Protocol
kHZ—kilohertz
km/h—kilometers per hour
LDAP—Lightweight Directory Access Protocol

LED—light-emitting diode

LOC—Local Operating Console

m—meter

MCO—Marine Corps Order

MEP—mobile electrical power

METOC—meteorology and oceanography

MIL-STD—military standard

MNS—mass notification system

MPEG—Moving Picture Experts Group

mph—miles per hour

NAVFACENGCOM HQ Code CHE—Naval Facilities Engineering Command, Headquarters Chief Engineer's Office

NCAS—Net-Centric Alerting System

NCEES—National Council of Examiners for Engineering and Surveys

NEMA—National Electrical Manufacturers Association

NFPA—National Fire Protection Association

NGA—National Geospatial-Intelligence Agency

NICET—National Institute for Certification in Engineering Technologies

NRTL—Nationally Recognized Testing Laboratory

NTIA—National Telecommunications and Information Administration

OCONUS—outside of the continental United States

OSHA—Occupational Safety and Health Administration

PA—public address

PC—personal computer

PDA—personal data assistant

ROC—regional operations center

SCIF—Sensitive, Compartmented Information Facilities

SE—Service Exception

STI—Speech Transmission Index

THD—total harmonic distortion

UFC—Unified Facilities Criteria

UL—Underwriters Laboratories, Inc.

UPS—uninterruptible power supply

VAC—volts of alternating current

VoIP—voice over IP

XML—Extensible Markup Language

Terms

Contractor—An entity that executes work in accordance with a contract.

Giant Voice—A nickname for the wide area outdoor siren and voice signaling system often found on military bases. An earlier name for this system was “Big Voice.”

Mass Notification System—A system that provides real-time information to all building occupants or personnel in the immediate vicinity of the building during emergency situations.

System Integrator—A contractor that designs, fabricates, installs, starts up, tests, and documents electrical and electronic systems using COTS components manufactured by others. Qualified manufacturers can act as system integrators.

APPENDIX A

REFERENCES

GOVERNMENT PUBLICATIONS

Public Law

\1\ *Architectural Barriers Act Accessibility Guidelines for Buildings and Facilities (ABAAG)*, 2004, <http://www.access-board.gov/ada-aba/> /1/

Executive Order 13347, *Individuals with Disabilities in Emergency Preparedness* (69 FR 44573), 26 July 2004, <http://www.archives.gov/federal-register/executive-orders/2004.html>

Executive Order 13407, *Public Alert and Warning System* (71 FR 36975), 28 June 2006, <http://a257.g.akamaitech.net/7/257/2422/01jan2006>.

National Technology Transfer and Advancement Act of 1995, (Public Law 104-113), 7 March 1996, <http://frwebgate.access.gpo.gov/cgi-bin/getdoc.publ113.104.pdf>

\1\ Department of Defense

Memorandum to Secretaries of the Military Departments et al., Subject: *Access for People with Disabilities*, dated 31 October 2008, <http://www.access-board.gov/ada-aba/dod-memorandum.htm> /1/

Departments of the Army, Air Force, and Navy

AFI 10-2501, *Air Force Emergency Management (EM) Program Planning and Operations*, 24 January 2007, Air Force Civil Engineer Support Agency, 139 Barnes Dr, Suite 1, Tyndall AFB, FL 32403-5319, <http://www.e-publishing.af.mil/>.

AFI 21-116, *Maintenance Management of Communications-Electronics*, 19 April 2005, Secretary of the Air Force, 3400 Defense Pentagon, Washington, DC 20301-3400, <http://www.e-publishing.af.mil/>.

MCO 3302.1, *The Marine Corps Antiterrorism Order*, Headquarters United States Marine Corps, Washington, DC 20380-0001, <http://www.usmc.mil/directiv.nsf/publications>.

MCO 5530.14, *Marine Corps Physical Security Program Manual*, Headquarters United States Marine Corps, Washington, DC 20380-0001, <http://www.usmc.mil/directiv.nsf/publications>.

MIL-STD-3007, *Department of Defense Standard Practice for Unified Facilities Criteria and Unified Facilities Guide Specifications*, Commander, Naval Facilities Engineering Command, Norfolk, VA 23508-1278, <http://www.wbdg.org/ccb/>.

UFC 3-310-01, *Structural Load Data*, 25 May 2005, Naval Facilities Engineering Command, 1322 Patterson Ave. SE, Suite 1000, Washington Navy Yard, D.C. 20374-5065, <http://www.wbdg.org/ccb/>.

UFC 3-520-01, *Interior Electrical Systems*, 10 June 2002, Air Force Civil Engineer Support Agency, 139 Barnes Dr, Suite 1, Tyndall AFB, FL 32403-5319, <http://www.wbdg.org/ccb/>.

UFC 3-600-02, *Operations and Maintenance: Inspection, Testing, and Maintenance of Fire Protection Systems*, 1 January 2001, Air Force Civil Engineer Support Agency, 139 Barnes Dr, Suite 1, Tyndall AFB, FL 32403-5319, <http://www.wbdg.org/ccb/>.

UFC 4-010-01, *DoD Minimum Antiterrorism Standards for Buildings*, 8 October 2003, Deputy Under Secretary of Defense (Installations and Environment), 3400 Defense Pentagon, Room 3C553, Washington, DC 20301-3400, <http://www.wbdg.org/ccb/>.

UFC 4-010-02, *DoD Minimum Standoff Distances for Buildings (FOUO)*, 8 October 2003, Deputy Under Secretary of Defense, Installations and Environment, Department of the Air Force, Washington, DC, <http://www.wbdg.org/ccb/>.

UFC 4-020-01FA, *Security Engineering: Project Development (FOUO)*, 1 March 2005, U.S. Army Corps of Engineers, 441 G. Street, NW, Washington, DC 20314-1000, <http://www.wbdg.org/ccb/>.

UFC 4-020-02FA, *Security Engineering: Concept Design (FOUO)*, 1 March 2005, U.S. Army Corps of Engineers, 441 G. Street, NW, Washington, DC 20314-1000, <http://www.wbdg.org/ccb/>.

Central Intelligence Agency

DCID 6/9, *Physical Security Standards for Sensitive Compartmented Information Facilities*, 18 November 2002, Central Intelligence Agency, Washington, D.C. 20505, <http://www.fas.org/irp/offdocs/dcid6-9.htm>.

Department of Commerce

National Telecommunications and Information Administration (NTIA) *Manual of Regulations and Procedures for Federal Radio Frequency Management*, 2003 (R 2006), Herbert C. Hoover Building (HCHB), U.S. Department of Commerce/NTIA, 1401 Constitution Avenue, N.W., Washington, D.C. 20230, <http://www.ntia.doc.gov/osmhome/redbook/redbook.html>

Department of Labor, Occupational Safety and Health Administration (OSHA)

Title 29, Code of Federal Regulations (CFR), Part 1910.165, *Employee Alarm Systems*, <http://www.gpoaccess.gov/cfr/index.html>.

29 CFR 1910.95, *Occupational Noise Exposure*, <http://www.gpoaccess.gov/cfr/index.html>.

29 CFR 1926.52, *Occupational Noise Exposure*, <http://www.gpoaccess.gov/cfr/index.html>.

Federal Communications Commission

Title 47, Code of Federal Regulations, Part 15, *Radio Frequency Devices*, 2006, Federal Communications Commission, 445 12th Street SW, Washington, DC 20554, http://www.access.gpo.gov/nara/cfr/waisidx_02/47cfr15_02.html.

National Security Agency

CSC-STD-002-85, *DOD Password Management Guideline*, National Computer Security Center (NCSC), National Security Agency, Fort George G. Meade, Maryland 20755, <http://csrc.nist.gov/secpubs/rainbow/nsapubs.txt>.

NONGOVERNMENT PUBLICATIONS

American National Standards Institute (ANSI), S3.2-1989 (R1999), *Method for Measuring the Intelligibility of Speech over Communications Systems*, 1819 L Street NW, Washington, DC 20036, <http://ansi.org/>.

Association of Public-Safety Communications Officials (APCO) Project 25, December 2002, *Standards for Public Safety Digital Radio*, 351 N. Williamson Blvd., Daytona Beach, FL 32114-1112, <http://www.apcointl.org/index.html>.

International Electrotechnical Commission (IEC) 60268-16, 2003, *Objective Rating of Speech Intelligibility by Speech Transmission Index*, 3, rue de Varembé, P.O. Box 131, CH-1211 Geneva 20 Switzerland, <http://www.iec.ch/index.html>.

IEC 60849, *Sound Systems for Emergency Purposes*, 1998, 3, rue de Varembé, P.O. Box 131, CH-1211 Geneva 20 Switzerland, <http://www.iec.ch/index.html>.

National Fire Protection Association (NFPA) 70, *National Electrical Code®*, 2008, 1 Batterymarch Park, P.O. 9101, Quincy, MA 02169-7471, <http://www.nfpa.org>.

NFPA 70B, *Recommended Practice for Electrical Equipment Maintenance*, 2006, 1 Batterymarch Park, P.O. 9101, Quincy, MA 02169-7471, <http://www.nfpa.org>.

NFPA 72, *National Fire Alarm Code®*, 2007, 1 Batterymarch Park, P.O. 9101, Quincy, MA 02169-7471, <http://www.nfpa.org>.

NFPA 101®, *Life Safety Code®*, 2006, 1 Batterymarch Park, P.O. 9101, Quincy, MA

02169-7471, <http://www.nfpa.org>.

UL 48-2004, *Standard for Electric Signs*, Underwriters Laboratory, Inc., 333 Pfingsten Road, Northbrook, IL 60062-2096, <http://ulstandardsinfonet.ul.com/>.

Underwriters Laboratory, Inc. (UL) 864-2007, *Standard for Control Units and Accessories for Fire Alarm Systems*, 333 Pfingsten Road, Northbrook, IL 60062-2096, <http://ulstandardsinfonet.ul.com/>.

UL 1480-2005, *Standard for Speakers for Fire Alarm, Emergency, and Commercial and Professional Use*, Underwriters Laboratory, Inc., 333 Pfingsten Road, Northbrook, IL 60062-2096, <http://ulstandardsinfonet.ul.com/>.

UL 1638-2003, *Standard for Visual Signaling Appliances-Private- Mode Emergency and General Utility Signaling*, Underwriters Laboratory, Inc., 333 Pfingsten Road, Northbrook, IL 60062-2096, <http://ulstandardsinfonet.ul.com/>.

UL 1971-2006, *Standard for Signaling Devices for the Hearing Impaired*, Underwriters Laboratory, Inc., 333 Pfingsten Road, Northbrook, IL 60062-2096, <http://ulstandardsinfonet.ul.com/>.

UL 2017-2005, *Standard for General-Purpose Signaling Devices and Systems*, Underwriters Laboratory, Inc., 333 Pfingsten Road, Northbrook, IL 60062-2096, <http://ulstandardsinfonet.ul.com/>.

APPENDIX B

SAMPLE PRE-RECORDED MNS MESSAGES

B-1 **OVERVIEW.** Pre-recorded messages are not required, but can prove beneficial in emergency situations. This appendix contains the sample text for pre-recorded MNS messages based on actual messages in use at several DOD installations. These sample messages are provided for information only to assist DOD installations in defining the content of their pre-recorded MNS messages. Each DOD installation should create MNS messages appropriate for its particular locale.

\1\ **Note:** DOD has implemented a requirement for a standardized alerting sound to be played prior to playing pre-recorded messages for new and replacement MNS. (Refer to paragraphs 4-4.2 and 5-5.2). The following messages were fielded prior to establishment of the requirement and some do not include the currently required alerting sound. /1/

B-2 **SAMPLE PRE-RECORDED MESSAGES**

B-2.1 **ARMY: FORT XXX.** All messages were recorded in a female voice.

B-2.1.1 **Red-Fire.** Five seconds of siren are played, followed by the message:

“Attention, attention. A fire emergency has been reported. Please leave the building using the nearest exit.”

B-2.1.2 **Blue-Weather.** Five seconds of 100-kHz steady tone are played, followed by the message:

“The National Weather Service has issued a weather alert for this area; further information will be broadcast as it becomes available.”

B-2.1.3 **Orange-Force Protection Antiterrorism Threat.** Five seconds of fast whoop sound are played, followed by the message:

“Attention. A force protection antiterrorism threat has been issued for this area. Effective immediately, we are operating, ‘secure and lockdown procedures.’ All personnel should remain calm and stay where you are. Please wait for further instructions.”

B-2.1.4 **Green-All Clear.** Five seconds of chime sound are played, followed by the message:

“The emergency has now ended. Please resume normal operations. Thank you for your cooperation.”

B-2.2 AIR FORCE: XXY Air Force Base

B-2.2.1 MESSAGE #1. A 1-kHz tone is sounded for 5 seconds, followed by the message:

“May I have your attention, please. This is the command post with a test of the ____ Air Force Base mass notification system. Repeat, this is only a test.”

B-2.2.2 MESSAGE #2. Five seconds of wail are played, followed by the message:

“Attention, attention. ____ Air Force Base is in Force Protection Condition Charlie. All personnel immediately implement FPCON Charlie actions.”

B-2.2.3 MESSAGE #3. Five seconds of wail are played, followed by the message:

“Attention, attention. ____ Air Force Base is in Force Protection Condition Delta. All personnel immediately implement FPCON Delta actions.”

B-2.2.4 MESSAGE #4. No alerting tone is used. The message played is:

“May I have your attention, please. All clear. The emergency has ended.”

B-2.2.5 MESSAGE #5. One round of code 3 horn is played, followed by the message:

“Your attention, please. ____ Air Force Base has issued a severe weather warning. Take required actions and tune into local radio or television for the latest update.”

B-2.2.6 MESSAGE #6. One round of code 3 temporal is played, followed by the message:

“Attention. A fire emergency has been reported. Please evacuate the building.”

B-2.3 Air Force: XXZ Air Force Base. Messages were pre-programmed for the MNS ACU and recorded in a male voice. All messages are repeated twice.

B-2.3.1 Force Protection Condition Alert. This message is labeled “FPCON ALERT.” A siren is played for 5 seconds (sound clip from manufacturer), followed by the message:

“Attention, attention. The Force Protection Condition for ____ AFB has been elevated. All personnel are to immediately implement prescribed actions. Tune your television to the Commander’s access channel or access the base intranet for further information.”

B-2.3.2 Peacetime Emergency Warning. This message is labeled “Peacetime emergency.” A horn sound is played for 5 seconds (sound clip from the manufacturer), followed by the message:

“Your attention, please. An emergency has been reported on ____ AFB. Immediately take shelter inside a facility. Remain in place and await further instructions.”

B-2.3.3 Severe Weather Warning. This message is labeled “Severe Weather.” A horn sound is played for 5 seconds (sound clip from the manufacturer), followed by the message:

“Your attention, please. A severe weather warning has been issued for ____ AFB. Take appropriate action and tune in to the local radio or television stations for the latest updates.”

B-2.3.4 Natural Disaster Warning. This message is labeled “Natural Disaster.” A horn sound is played for 5 seconds (sound clip from the manufacturer), followed by the message:

“Your attention, please. A natural disaster has either occurred or is expected shortly that will impact ____ AFB. Take appropriate action and tune in to the local radio or television stations for the latest updates.”

B-2.4 AIR FORCE: XYX Air Force Base. Messages were recorded in a male voice. The language used was English.

B-2.4.1 Three 1-kilohertz (kHz) tones (one second each) are played, followed by the message:

“Attention, attention. Implement Force Protection Condition Delta. Refer to ____ AFB intranet for current Battle Staff Directive.”

B-2.4.2 Three 1-kHz tones (one second each) are played, followed by the message:

“Attention, attention. Disaster control group recall. Report to primary rally point.”

B-2.4.3 Three 1-kHz tones (one second each) are played, followed by the message:

“Attention, attention. All personnel shelter in place.”

B-2.4.4 Three 1-kHz tones (one second each) are played, followed by the message:

“Attention, attention. Battle-staff recall. Key personnel report to command post.”

B-2.4.5 Three 1-kHz tones (one second each) are played, followed by the message:

“Attention, attention. Implement Force Protection Condition Charlie. Refer to ____ AFB intranet for current Battle Staff Directive.”

B-2.4.6 Three 1-kHz tones (one second each) are played, followed by the message:

“Attention, attention. Implement Force Protection Condition Bravo. Refer to ____ AFB intranet for current Battle Staff Directive.”

B-2.4.7 Three 1-kHz tones (one second each) are played, followed by the message:

“Attention, attention. Implement Force Protection Condition Alpha. Refer to ____ AFB intranet for current Battle Staff Directive.”

B-2.4.8 No alerting tone is used. Message played is:

“May I have your attention, please. The National Weather Service has issued a severe weather warning for our area.”

B-2.5 **AIR FORCE: XYY Air Force Base.** Messages were pre-programmed for the MNS ACU and recorded in a male voice. All messages were repeated twice.

B-2.5.1 **Force Protection Condition Alert.** This message is labeled “FPCON.” The button color used was red. A siren is played for 5 seconds (sound clip from manufacturer), followed by the message:

“Attention, attention. The Force Protection Condition for ____ AFB has been changed. All personnel are to immediately implement prescribed actions. Tune your television to the Commander’s access channel or access the base intranet for further information.”

B-2.5.2 **Bomb Threat Warning.** This message is labeled “BOMB.” The button color used was red. A horn sound is played for 5 seconds (sound clip from the manufacturer), followed by the message;

“Attention, attention. A bomb threat alert has been issued for this building. All personnel are to evacuate immediately using the nearest exit. Further instructions will be issued outside the building by emergency response teams.”

B-2.5.3 **Terrorist Threat Warning.** This message is labeled “TERRORIST.” The button color used was red. A horn sound is played for 5 seconds (sound clip from the manufacturer), followed by the message:

“May I have your attention, please. A terrorist threat has been received. Effective immediately, we are operating ‘secure and lockdown procedures.’ All personnel should remain calm and stay where you are. Please await further instructions.”

B-2.5.4 All Clear. This message is labeled “ALL CLEAR.” The button color used was blue. A horn sound is played for 5 seconds (sound clip from manufacturer), followed by the message:

“The building emergency has now ended. Please resume your normal duties. Thank you for your cooperation.”

APPENDIX C

NET-CENTRIC ALERTING SYSTEMS (NCAS)

C-1 **OVERVIEW.** This appendix provides information on on-going development of system requirements for alerting systems that will be based on IP technologies. This appendix is not mandatory but is provided to stimulate development of suitable requirements and standards for DOD installations. Consequently, user suggestions and feedback on this appendix are highly encouraged and requested. Methods to ensure reliability and robustness in off-normal or emergency conditions are of particular concern. The required amount of and method for isolating alerting functions from normal, non-alerting system functions needs development. The need for listing or approval by NRTLs is also an area of investigation.

C-2 **SUGGESTED CAPABILITIES OF A NCAS**

C-2.1 **Overview.** NCAS are enterprise-class systems for the management of and mass distribution of emergency notification messages within buildings, throughout installations, across entire geographical regions, or throughout a worldwide military command. Net-centric alerting may not be used in lieu of required audible alerting MNS but should be integrated with MNS whenever possible. Using NCAS, designated system operators would be able to rapidly and reliably inform appropriate personnel about anti-terrorism/force protection conditions (FPCON) (including chemical, biological, radiological, and nuclear threats), hazardous weather conditions, and many other critical events—possibly with near real-time response capability. NCAS leverages the IP network infrastructure to instantly reach those personnel who have access to nearly any IP-connected devices (such as pop-up alerts on personal computers (PC), text messages to personal data assistants (PDA) and cellular telephones, electronic mail to IP-capable cellular telephones, and recorded voice messages to voice-over-IP (VoIP) telephones and PCs). Additionally, NCAS could be used to activate, through a single interface, non-IP alerting systems such as giant voice outdoor warning systems and traditional dial-up telephone alerting systems.

NCAS would also enable the central management of the entire notification flow, including users' management, groups targeting, operators' permissions, access policies, pre-defined emergency scenarios, and response tracking and reporting. This capability would provide NCAS with the flexibility to comply with existing concept of operations (CONOPS) for emergency management (EM) and personnel notifications. NCAS could also monitor external sensors and third-party sources of emergency events, such as government-supplied weather information, and could be used to automatically initiate alerts based on pre-defined alerting scenarios.

C-2.2 **Installed Independently in each Facility or centrally in a 24/7 Regional Operations Center (ROC).** NCAS would be installed independently in each installation/facility (such as in the base network control center) or centrally in a 24/7 ROC that covers multiple geographically separated facilities and installations.

In a centrally managed NCAS configuration, personnel and facilities in the ROC's particular area of coverage could be alerted instantly by events either from any individual installation or centrally from the ROC. Using management tools, designated operators from each installation in the region could log in via a Web browser and have complete access to their own portion of the NCAS. The ROC would retain the ability to centrally monitor and manage all portions of the system.

C-2.3 Network Security Compliance. The NCAS would be installed behind the appropriate Internet system firewalls. It would be provided with net-centric architecture that fully supports DOD networking standards and security requirements. More specifically, the NCAS would use a Web-based user interface, support DOD standard network ports and protocols, and provide open interfaces to support interoperability such as Extensible Markup Language (XML)- and common \1\ alert /1/ protocol (CAP)-based emergency messages. The system would include provisions for secure communications, authentication, and encryption using DOD and industry-standard encryption technologies. The system would be DOD Information Technology Security Certification and Accreditation Process/DOD Information Assurance Certification and Accreditation Process (DITSCAP/DIACAP) approved/certified, comply with DOD Computer Security Center Standard (CSC-STD) 002-85, and have a proven support for DOD Common Access Card (CAC) authentication.

C-2.4 General NCAS Functionality. The NCAS would be a COTS software product and use industry standards. The NCAS would have server-based architecture, allowing central alert activation, control, and management; such server(s) would be connected to the local network and integrated with the local user directory (i.e., support for Lightweight Directory Access Protocol (LDAP) and Active Directory integration is required).

C-2.4.1 Delivery Methods. The NCAS would be capable of sending alert messages to end-users (recipients) via multiple delivery methods, including:

- Audio-visual network alerts to desktops and laptops via desktop pop-up
- Text alerts to mobile phones and pagers
- Text alerts to electronic mail (e-mail) clients
- Audio alerts to phones
- Audio alerts to existing outdoor PA/giant voice systems
- Network alerts to any other IP-connected devices via standard XML and CAP protocols

The system would be extendable to support additional delivery methods in the future as this technology develops.

C-2.4.2 **Targeted Recipients.** The NCAS would be capable of sending alert messages to target recipients according to:

- Hierarchical organizational structure (as would be imported from an LDAP or Active Directory)
- Organizational roles
- Specific distribution lists (e.g., hazardous materials (HAZMAT) response teams)
- Dynamic groups created through on-the-fly queries of the user directory
- Geographical locations (e.g., entire bases, zones within bases)
- IP addresses (required for targeting devices in specific physical locations)

C-2.4.3 **Tracking and Reporting Functions.** The NCAS would be able to centrally track, in real-time, all alerting activities for each individual recipient, including sending, receiving, and responding to alerts, and be able to generate reports based on tracked information.

C-2.4.4 **Signal and Message Library.** The NCAS would incorporate a pre-defined library of signals and messaging appropriate to:

- FPCONs
- Terrorism threats, watches, or warnings
- Evacuation routes
- Battle staff directives
- Personnel recall requirements
- Federal, DOD, or installation-specific warning and notification requirements

The NCAS would provide means for monitoring and integrating with external event sources, and activating alerts automatically based on identifying a match with pre-defined conditions.

C-2.4.5 **Web-based Management.** The NCAS would incorporate a Web-based management and alert activation application through which all operators and administrators could gain access to the system's capabilities based on the users' permissions and the defined access policy. Such a management application would incorporate management of the alert activation flow through all delivery methods, as well as end-user management, operators' permission and access, tracking and

reporting, and all administrative aspects of the system.

C-2.5 Interoperability. The NCAS would be able to interface and interoperate with UFC 4-021-01-compliant mass notification capabilities, including wide area MNS, individual building MNS, giant voice outdoor warning systems, and telephony alerting systems. During emergencies, systems operators should not need to send notifications using multiple alerting systems. The NCAS would provide the capability to integrate user interfaces and consolidate access to multiple mass notification and alerting systems.

C-2.6 Monitoring and Automating Emergency Alerts Flow. The NCAS would be capable of monitoring emergency notifications from multiple data sources (National Weather Service, Emergency Managers Weather Information Network (EMWIN), meteorology and oceanography (METOC), and others) and automatically sending out notifications to designated facilities and personnel based on pre-defined rules.

C-2.7 Back-up NCAS Systems. The NCAS would support multiple server configurations to achieve a “hot standby” failover configuration (i.e., no down time in case of failure in a single server) as well as to support higher load scenarios (e.g., more users).